



Chipsmall Limited consists of a professional team with an average of over 10 year of expertise in the distribution of electronic components. Based in Hongkong, we have already established firm and mutual-benefit business relationships with customers from,Europe,America and south Asia,supplying obsolete and hard-to-find components to meet their specific needs.

With the principle of “Quality Parts,Customers Priority,Honest Operation,and Considerate Service”,our business mainly focus on the distribution of electronic components. Line cards we deal with include Microchip,ALPS,ROHM,Xilinx,Pulse,ON,Everlight and Freescale. Main products comprise IC,Modules,Potentiometer,IC Socket,Relay,Connector.Our parts cover such applications as commercial,industrial, and automotives areas.

We are looking forward to setting up business relationship with you and hope to provide you with the best service and solution. Let us make a better world for our industry!



## Contact us

Tel: +86-755-8981 8866 Fax: +86-755-8427 6832

Email & Skype: info@chipsmall.com Web: www.chipsmall.com

Address: A1208, Overseas Decoration Building, #122 Zhenhua RD., Futian, Shenzhen, China



**ISOTOP<sup>®</sup> Boost chopper  
High speed Trench + Field Stop IGBT4**

**$V_{CES} = 1200V$   
 $I_C = 40A @ T_c = 80^{\circ}C$**

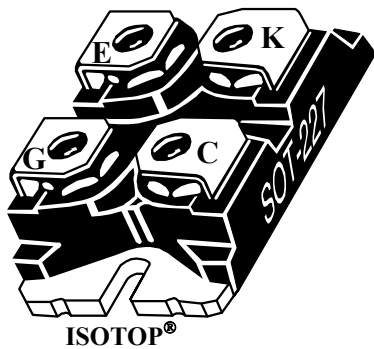
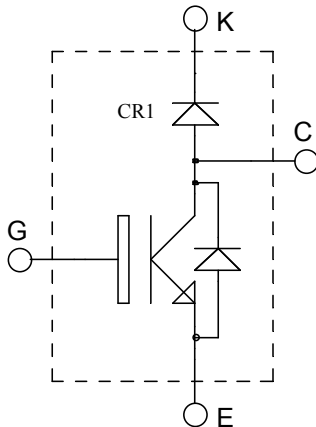

#### Application

- AC and DC motor control
- Switched Mode Power Supplies
- Power Factor Correction
- Brake switch

#### Features

- **High speed Trench + Field Stop IGBT 4 Technology**
  - Low voltage drop
  - Low leakage current
  - Low switching losses
  - RBSOA and SCSOA rated
- **SiC Schottky Diode (CR1)**
  - Zero reverse recovery
  - Zero forward recovery
  - Temperature Independent switching behavior
  - Positive temperature coefficient on VF
- ISOTOP<sup>®</sup> Package (SOT-227)
- Very low stray inductance
- High level of integration

#### Benefits

- Low conduction losses
- Stable temperature behavior
- Very rugged
- Direct mounting to heatsink (isolated package)
- Low junction to case thermal resistance
- Easy paralleling due to positive  $T_C$  of  $V_{CEsat}$
- RoHS Compliant

**All ratings @  $T_j = 25^{\circ}C$  unless otherwise specified**

#### Absolute maximum ratings

Symbol	Parameter	Max ratings	Unit
$V_{CES}$	Collector - Emitter Breakdown Voltage	1200	V
$I_C$	Continuous Collector Current	$T_C = 25^{\circ}C$	80
		$T_C = 80^{\circ}C$	40
$I_{CM}$	Pulsed Collector Current	$T_C = 25^{\circ}C$	160
$V_{GE}$	Gate - Emitter Voltage	$\pm 20$	V
$P_D$	Maximum Power Dissipation	$T_C = 25^{\circ}C$	312
RBSOA	Reverse Bias Safe Operating Area	$T_j = 150^{\circ}C$	80A @ 1100V

**CAUTION:** These Devices are sensitive to Electrostatic Discharge. Proper Handling Procedures Should Be Followed. See application note APT0502 on [www.microsemi.com](http://www.microsemi.com)

**Electrical Characteristics**

Symbol	Characteristic	Test Conditions	Min	Typ	Max	Unit	
$I_{CES}$	Zero Gate Voltage Collector Current	$V_{GE} = 0V, V_{CE} = 1200V$			25	$\mu A$	
$V_{CE(sat)}$	Collector Emitter saturation Voltage	$V_{GE} = 15V$ $I_C = 40A$	$T_j = 25^\circ C$ $T_j = 150^\circ C$	1.7 2.6	2.4	V	
$V_{GE(th)}$	Gate Threshold Voltage	$V_{GE} = V_{CE}, I_C = 1mA$		5.0	5.8	6.5	V
$I_{GES}$	Gate – Emitter Leakage Current	$V_{GE} = \pm 20V, V_{CE} = 0V$			120	nA	

**Dynamic Characteristics**

Symbol	Characteristic	Test Conditions	Min	Typ	Max	Unit
$C_{ies}$	Input Capacitance	$V_{GE} = 0V$		2300		pF
$C_{oes}$	Output Capacitance	$V_{CE} = 25V$		150		
$C_{res}$	Reverse Transfer Capacitance	$f = 1MHz$		130		
$Q_G$	Gate charge	$V_{GE} = 15V, I_C = 40A$ $V_{CE} = 960V$		185		nC
$T_{d(on)}$	Turn-on Delay Time	Resistive Switching ( $25^\circ C$ ) $V_{GE} = \pm 15V$ $V_{Bus} = 600V$ $I_C = 40A$ $R_G = 12\Omega$		30		ns
$T_r$	Rise Time			57		
$T_{d(off)}$	Turn-off Delay Time			290		
$T_f$	Fall Time			16		
$T_{d(on)}$	Turn-on Delay Time	Inductive Switching ( $150^\circ C$ ) $V_{GE} = \pm 15V$ $V_{Bus} = 600V$ $I_C = 40A$ $R_G = 12\Omega$		30		ns
$T_r$	Rise Time			49		
$T_{d(off)}$	Turn-off Delay Time			366		
$T_f$	Fall Time			48		
$E_{on}$	Turn-on Switching Energy	$V_{GE} = \pm 15V$ $V_{Bus} = 600V$ $I_C = 40A$	$T_j = 25^\circ C$ $T_j = 150^\circ C$	1.9 2.25		mJ
$E_{off}$	Turn-off Switching Energy	$R_G = 12\Omega$	$T_j = 25^\circ C$ $T_j = 150^\circ C$	1.2 2.25		
$I_{sc}$	Short Circuit data	$V_{GE} \leq 15V ; V_{Bus} = 600V$ $t_p \leq 10\mu s ; T_j = 150^\circ C$		150		A

**Chopper SiC diode ratings and characteristics (CR1)**

Symbol	Characteristic	Test Conditions	Min	Typ	Max	Unit	
$V_{RRM}$	Maximum Peak Repetitive Reverse Voltage		1200			V	
$I_{RM}$	Maximum Reverse Leakage Current	$V_R = 1200V$		$T_j = 25^\circ C$ $T_j = 175^\circ C$	64 112	400 2000	$\mu A$
$I_F$	DC Forward Current			$T_c = 100^\circ C$	20		A
$V_F$	Diode Forward Voltage	$I_F = 20A$		$T_j = 25^\circ C$ $T_j = 175^\circ C$	1.6 2.3	1.8 3	V
$Q_C$	Total Capacitive Charge	$I_F = 20A, V_R = 600V$ $di/dt = 1000A/\mu s$		80		nC	
$C$	Total Capacitance	$f = 1MHz, V_R = 200V$ $f = 1MHz, V_R = 400V$		192 138		pF	



## Thermal and package characteristics

Symbol	Characteristic	Min	Typ	Max	Unit
R <sub>thJC</sub>	Junction to Case Thermal Resistance	IGBT		0.48	°C/W
		SiC Diode		0.8	
R <sub>thJA</sub>	Junction to Ambient (IGBT & Diode)			20	
V <sub>ISOL</sub>	RMS Isolation Voltage, any terminal to case t=1 min, 50/60Hz	4000			V
T <sub>J</sub> , T <sub>STG</sub>	Storage Temperature Range	-55		150	°C
T <sub>L</sub>	Max Lead Temp for Soldering: 0.063" from case for 10 sec			300	
Torque	Mounting torque (Mounting = 8-32 or 4mm Machine and terminals = 4mm Machine)			1.5	N.m
Wt	Package Weight		29.2		g

## SOT-227 (ISOTOP<sup>®</sup>) Package Outline

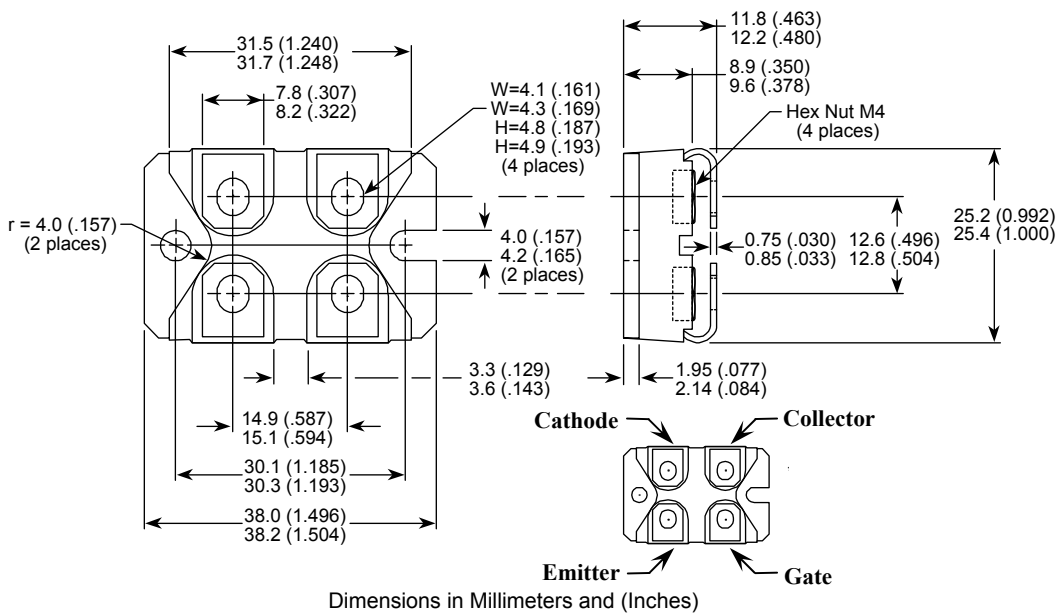

## Typical IGBT Performance Curve

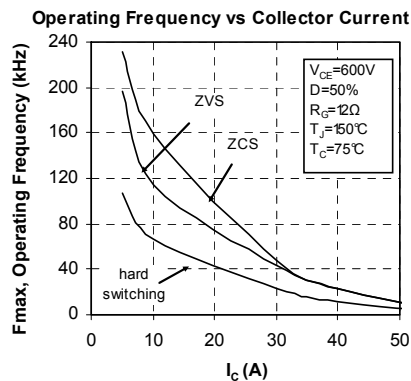

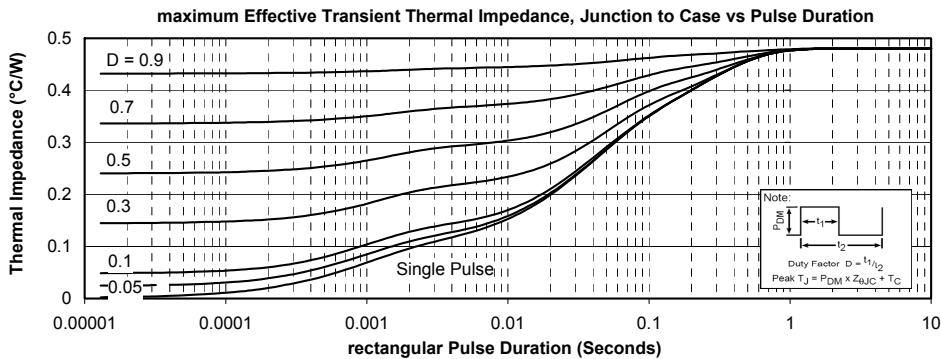
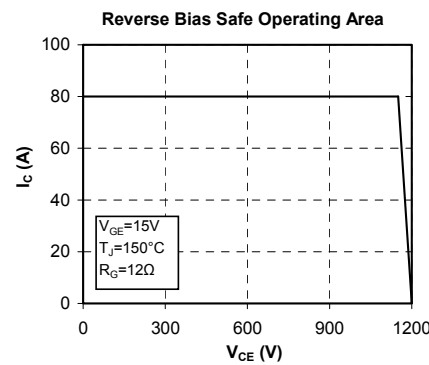
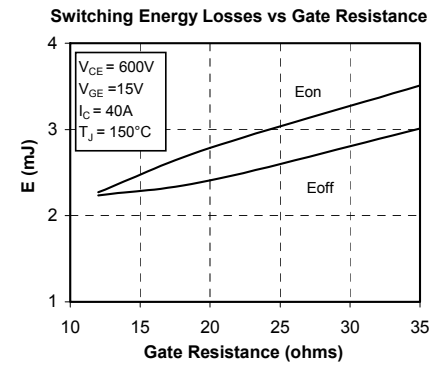
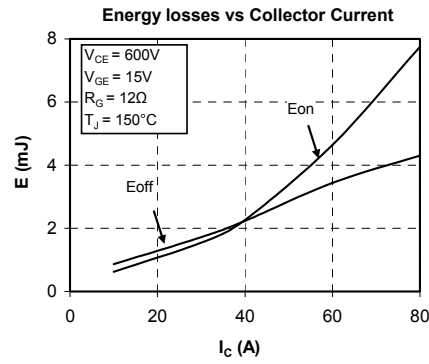
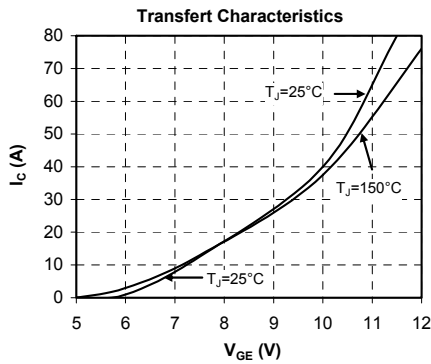
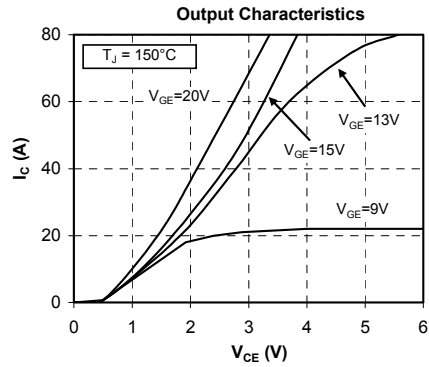
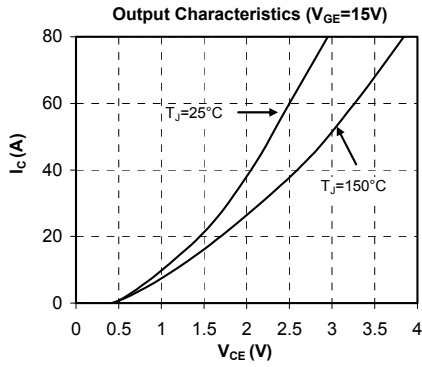

## Typical chopper SiC diode Performance Curve

Maximum Effective Transient Thermal Impedance, Junction to Case vs Pulse Duration

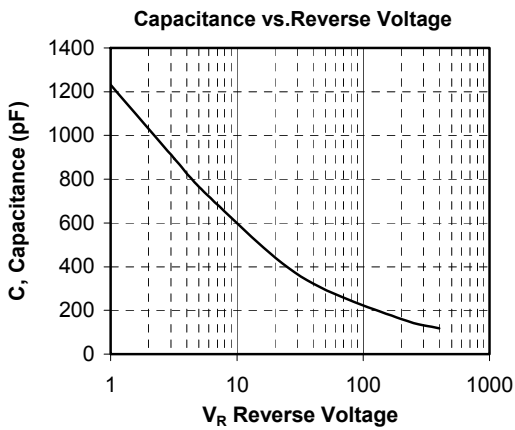
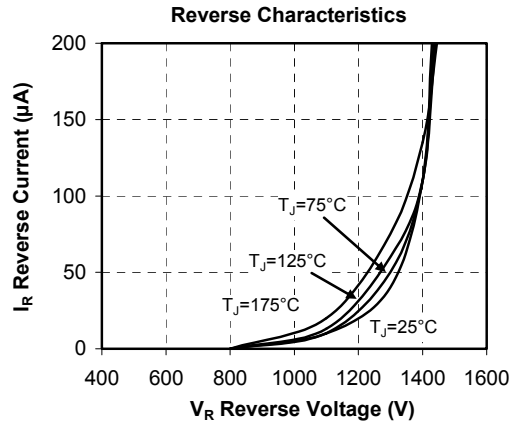
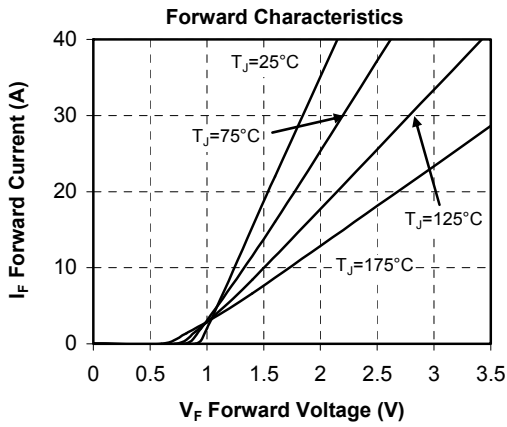
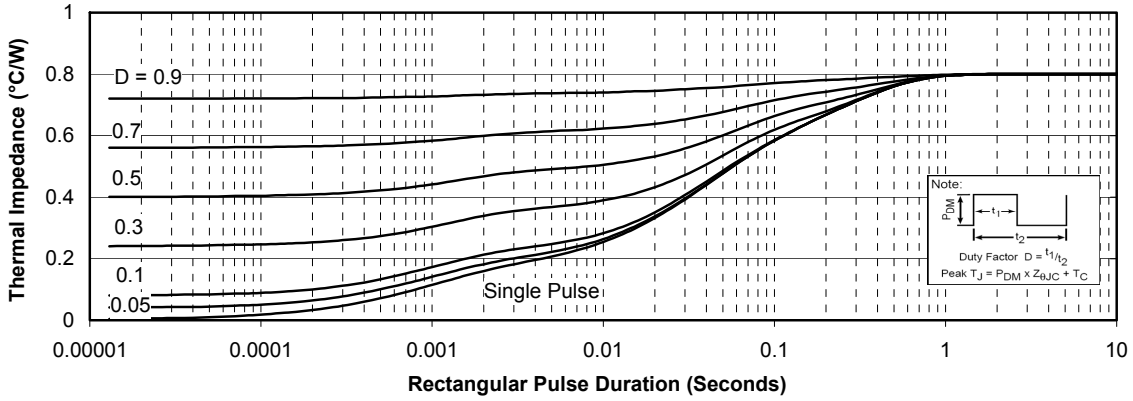

ISOTOP® is a registered trademark of ST Microelectronics NV

DISCLAIMER

The information contained in the document (unless it is publicly available on the Web without access restrictions) is PROPRIETARY AND CONFIDENTIAL information of Microsemi and cannot be copied, published, uploaded, posted, transmitted, distributed or disclosed or used without the express duly signed written consent of Microsemi. If the recipient of this document has entered into a disclosure agreement with Microsemi, then the terms of such Agreement will also apply. This document and the information contained herein may not be modified, by any person other than authorized personnel of Microsemi. No license under any patent, copyright, trade secret or other intellectual property right is granted to or conferred upon you by disclosure or delivery of the information, either expressly, by implication, inducement, estoppels or otherwise. Any license under such intellectual property rights must be approved by Microsemi in writing signed by an officer of Microsemi.

Microsemi reserves the right to change the configuration, functionality and performance of its products at anytime without any notice. This product has been subject to limited testing and should not be used in conjunction with life-support or other mission-critical equipment or applications. Microsemi assumes no liability whatsoever, and Microsemi disclaims any express or implied warranty, relating to sale and/or use of Microsemi products including liability or warranties relating to fitness for a particular purpose, merchantability, or infringement of any patent, copyright or other intellectual property right. Any performance specifications believed to be reliable but are not verified and customer or user must conduct and complete all performance and other testing of this product as well as any user or customers final application. User or customer shall not rely on any data and performance specifications or parameters provided by Microsemi. It is the customer's and user's responsibility to independently determine suitability of any Microsemi product and to test and verify the same. The information contained herein is provided "AS IS, WHERE IS" and with all faults, and the entire risk associated with such information is entirely with the User. Microsemi specifically disclaims any liability of any kind including for consequential, incidental and punitive damages as well as lost profit. The product is subject to other terms and conditions which can be located on the web at <http://www.microsemi.com/legal/tnc.asp>

Life Support Application

Seller's Products are not designed, intended, or authorized for use as components in systems intended for space, aviation, surgical implant into the body, in other applications intended to support or sustain life, or for any other application in which the failure of the Seller's Product could create a situation where personal injury, death or property damage or loss may occur (collectively "Life Support Applications").

Buyer agrees not to use Products in any Life Support Applications and to the extent it does it shall conduct extensive testing of the Product in such applications and further agrees to indemnify and hold Seller, and its officers, employees, subsidiaries, affiliates, agents, sales representatives and distributors harmless against all claims, costs, damages and expenses, and attorneys' fees and costs arising, directly or indirectly, out of any claims of personal injury, death, damage or otherwise associated with the use of the goods in Life Support Applications, even if such claim includes allegations that Seller was negligent regarding the design or manufacture of the goods.

Buyer must notify Seller in writing before using Seller's Products in Life Support Applications. Seller will study with Buyer alternative solutions to meet Buyer application specification based on Sellers sales conditions applicable for the new proposed specific part.