



Chipsmall Limited consists of a professional team with an average of over 10 year of expertise in the distribution of electronic components. Based in Hongkong, we have already established firm and mutual-benefit business relationships with customers from,Europe,America and south Asia,supplying obsolete and hard-to-find components to meet their specific needs.

With the principle of “Quality Parts,Customers Priority,Honest Operation,and Considerate Service”,our business mainly focus on the distribution of electronic components. Line cards we deal with include Microchip,ALPS,ROHM,Xilinx,Pulse,ON,Everlight and Freescale. Main products comprise IC,Modules,Potentiometer,IC Socket,Relay,Connector.Our parts cover such applications as commercial,industrial, and automotives areas.

We are looking forward to setting up business relationship with you and hope to provide you with the best service and solution. Let us make a better world for our industry!



Contact us

Tel: +86-755-8981 8866 Fax: +86-755-8427 6832

Email & Skype: info@chipsmall.com Web: www.chipsmall.com

Address: A1208, Overseas Decoration Building, #122 Zhenhua RD., Futian, Shenzhen, China



Thunderbolt IGBT®

The Thunderbolt IGBT® is a new generation of high voltage power IGBTs. Using Non-Punch-Through Technology, the Thunderbolt IGBT® offers superior ruggedness and ultrafast switching speed.

Features

- Low Forward Voltage Drop
- Low Tail Current
- RoHS Compliant 
- RBSOA and SCSOA Rated
- High Frequency Switching to 150KHz
- Ultra Low Leakage Current

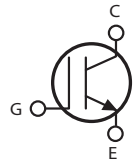
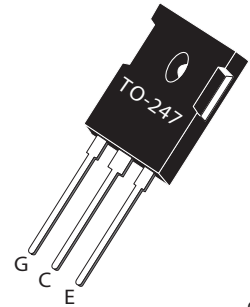

Maximum Ratings

 All Ratings: $T_C = 25^\circ C$ unless otherwise specified.

Symbol	Parameter	Ratings	Unit
V_{CES}	Collector-Emitter Voltage	600	Volts
V_{GE}	Gate-Emitter Voltage	± 20	
I_{C1}	Continuous Collector Current @ $T_C = 25^\circ C$	80	Amps
I_{C2}	Continuous Collector Current @ $T_C = 105^\circ C$	40	
I_{CM}	Pulsed Collector Current ^①	160	
SSOA	Switching Safe Operating Area @ $T_J = 150^\circ C$	160A @ 600V	
P_D	Total Power Dissipation	345	Watts
T_J, T_{STG}	Operating and Storage Junction Temperature Range	-55 to 150	$^\circ C$

Static Electrical Characteristics

Symbol	Characteristic / Test Conditions	Min	Typ	Max	Unit
$V_{(BR)CES}$	Collector-Emitter Breakdown Voltage ($V_{GE} = 0V, I_C = 5mA$)	600	-	-	Volts
$V_{GE(TH)}$	Gate Threshold Voltage ($V_{CE} = V_{GE}, I_C = 500\mu A, T_J = 25^\circ C$)	3	4	5	
$V_{CE(ON)}$	Collector Emitter On Voltage ($V_{GE} = 15V, I_C = 40A, T_J = 25^\circ C$)	1.6	2.15	2.5	
	Collector Emitter On Voltage ($V_{GE} = 15V, I_C = 40A, T_J = 125^\circ C$)	-	-	2.8	
I_{CES}	Collector Cut-off Current ($V_{CE} = 600V, V_{GE} = 0V, T_J = 25^\circ C$) ^②	-	-	80	μA
	Collector Cut-off Current ($V_{CE} = 600V, V_{GE} = 0V, T_J = 125^\circ C$) ^②	-	-	2000	
I_{GES}	Gate-Emitter Leakage Current ($V_{GE} = \pm 20V$)	-	-	100	nA

 CAUTION: These Devices are Sensitive to Electrostatic Discharge. Proper Handling Procedures Should Be Followed.

Dynamic Characteristic

APT40GT60BR

Symbol	Characteristic	Test Conditions	Min	Typ	Max	Unit
C_{ies}	Input Capacitance	$V_{GE} = 0V, V_{CE} = 25V$ $f = 1MHz$	-	2190	-	pF
C_{oes}	Output Capacitance		-	220	-	
C_{res}	Reverse Transfer Capacitance		-	130	-	
V_{GEP}	Gate-to-Emitter Plateau Voltage	Gate Charge $V_{GE} = 15V$ $V_{CE} = 300V$ $I_C = 40A$	-	8.0	-	V
Q_g	Total Gate Charge ^③		-	200	-	nC
Q_{ge}	Gate-Emitter Charge		-	12	-	
Q_{gc}	Gate-Collector Charge		-	86	-	
SSOA	Switching Safe Operating Area	$T_J = 150^\circ C, R_G = 5\Omega, V_{GE} = 15V, L = 100\mu H, V_{CE} = 600V$	160			A
$t_{d(on)}$	Turn-On Delay Time	Inductive Switching (25°C) $V_{CC} = 400V$ $V_{GE} = 15V$ $I_C = 40A$ $R_G = 5\Omega$ $T_J = +25^\circ C$	-	12	-	ns
t_r	Current Rise Time		-	36	-	
$t_{d(off)}$	Turn-Off Delay Time		-	124	-	
t_f	Current Fall Time		-	55	-	
E_{on1}	Turn-On Switching Energy ^④		-	-	-	
E_{on2}	Turn-On Switching Energy ^⑤	-	945	-		
E_{off}	Turn-Off Switching Energy ^⑥	-	828	-		
$t_{d(on)}$	Turn-On Delay Time	Inductive Switching (125°C) $V_{CC} = 400V$ $V_{GE} = 15V$ $I_C = 40A$ $R_G = 5\Omega$ $T_J = +125^\circ C$	-	12	-	ns
t_r	Current Rise Time		-	33	-	
$t_{d(off)}$	Turn-Off Delay Time		-	165	-	
t_f	Current Fall Time		-	58	-	
E_{on1}	Turn-On Switching Energy ^④		-	-	-	μJ
E_{on2}	Turn-On Switching Energy ^⑤		-	1342	-	
E_{off}	Turn-Off Switching Energy ^⑥		-	1150	-	

Thermal and Mechanical Characteristics

Symbol	Characteristic / Test Conditions	Min	Typ	Max	Unit
$R_{\theta JC}$	Junction to Case (IGBT)	-	-	0.36	°C/W
$R_{\theta JC}$	Junction to Case (DIODE)	-	-	N/A	
W_T	Package Weight	-	6.1	-	g
Torque	Terminals and Mounting Screws	-	-	10	in-lbf
		-	-	1.1	N·m
$V_{isolation}$	RMS Voltage (50-60Hz Sinusoidal Waveform from Terminals to Mounting Base for 1 Min.)	2500	-	-	Volts

① Repetitive Rating: Pulse width limited by maximum junction temperature.

② For Combi devices, I_{ces} includes both IGBT and FRED leakages.

③ See MIL-STD-750 Method 3471.

④ E_{on1} is the clamped inductive turn-on energy of the IGBT only, without the effect of a commutating diode reverse recovery current adding to the IGBT turn-on loss. Tested in inductive switching test circuit shown in figure 21, but with a Silicon Carbide diode.

⑤ E_{on2} is the clamped inductive turn-on energy that includes a commutating diode reverse recovery current in the IGBT turn-on switching loss. (See Figures 21, 22.)

⑥ E_{off} is the clamped inductive turn-off energy measured in accordance with JEDEC standard JESD24-1. (See Figures 21, 23.)

⑦ R_G is external gate resistance not including gate driver impedance.

Microsemi reserves the right to change, without notice, the specifications and information contained herein.

Typical Performance Curves

APT40GT60BR

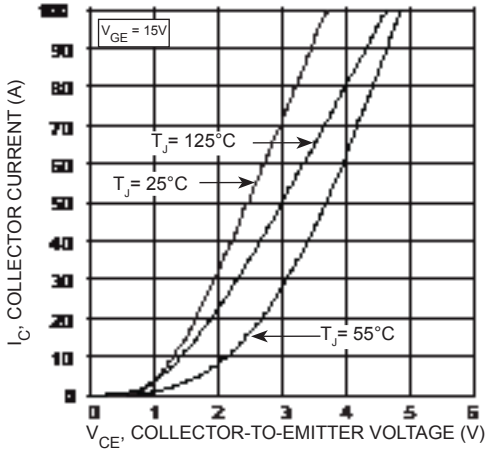

FIGURE 1, Output Characteristics ($T_J = 25^\circ\text{C}$)

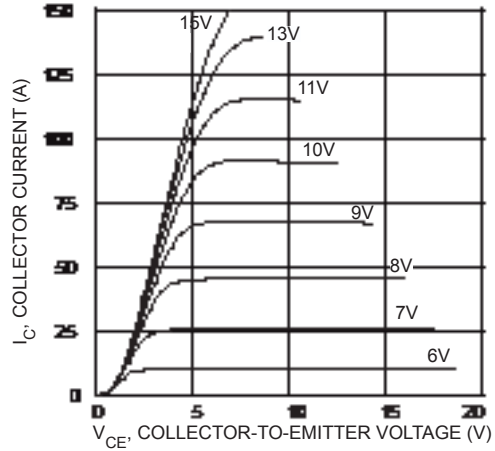

FIGURE 2, Output Characteristics ($T_J = 25^\circ\text{C}$)

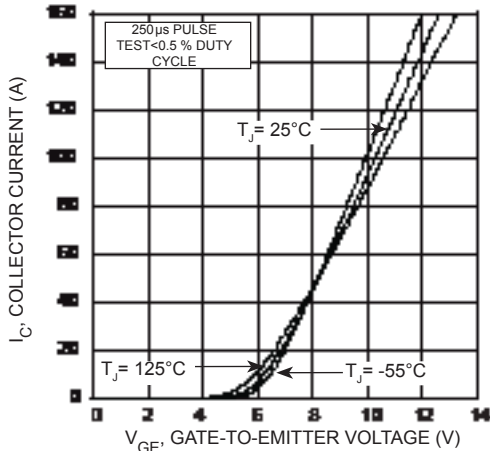

FIGURE 3, Transfer Characteristics

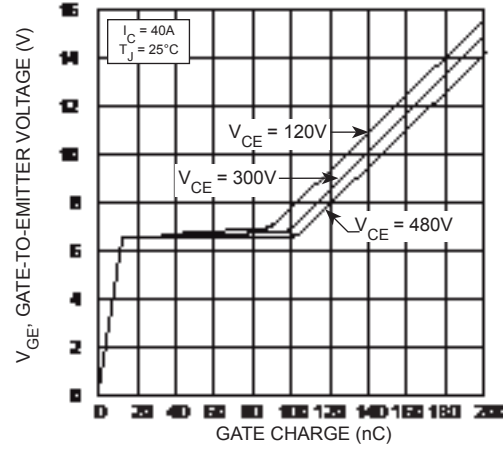

FIGURE 4, Gate charge

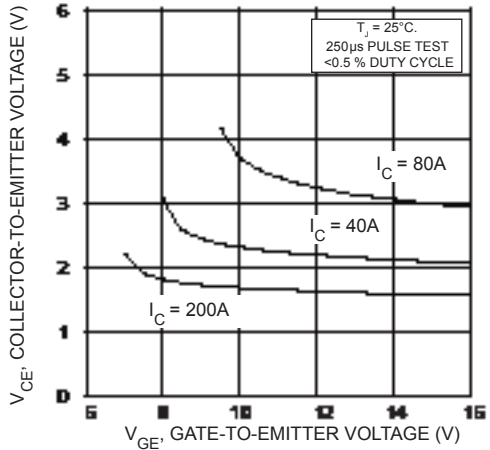

FIGURE 5, On State Voltage vs Gate-to-Emitter Voltage

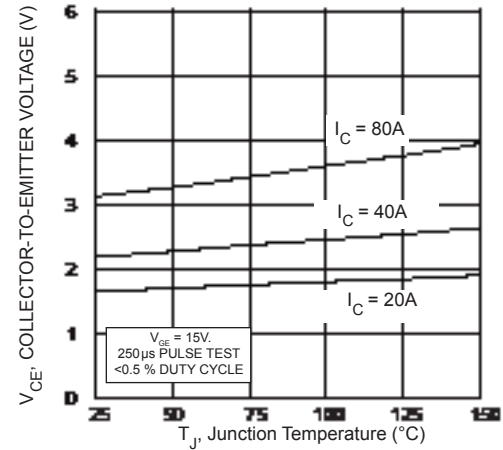

FIGURE 6, On State Voltage vs Junction Temperature

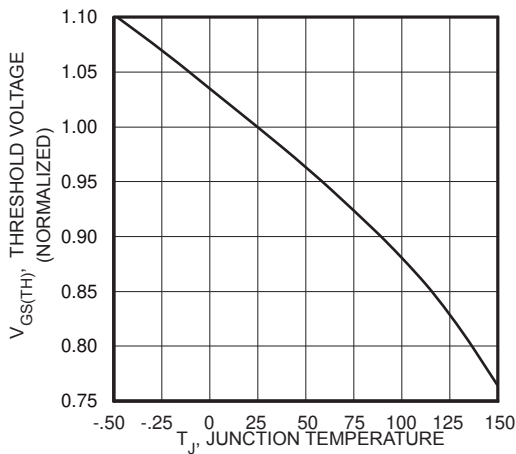

FIGURE 7, Threshold Voltage vs Junction Temperature

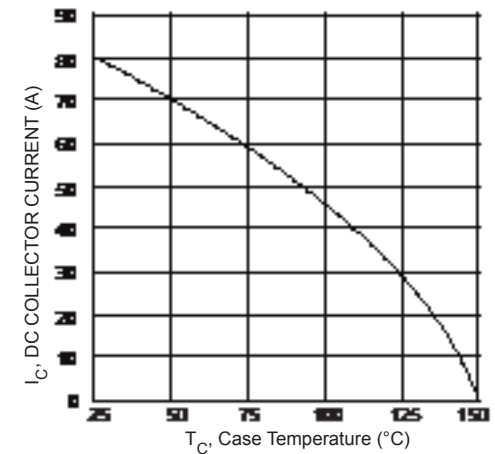

FIGURE 8, DC Collector Current vs Case Temperature

Typical Performance Curves

APT40GT60BR

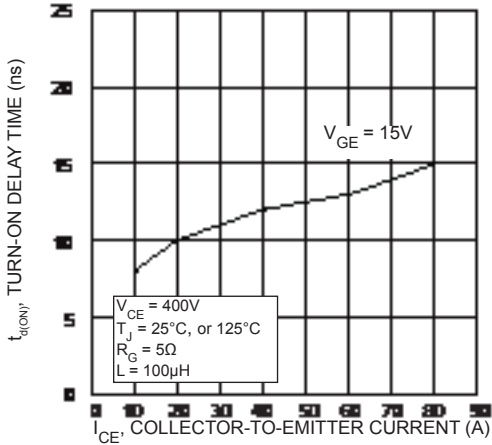

FIGURE 9, Turn-On Delay Time vs Collector Current

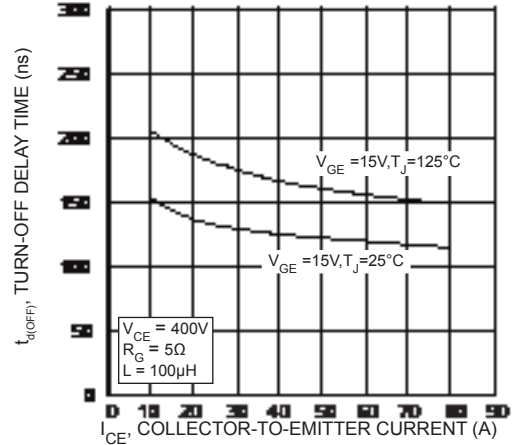

FIGURE 10, Turn-Off Delay Time vs Collector Current

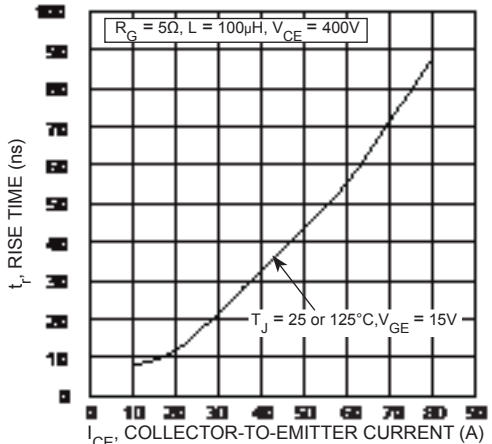

FIGURE 11, Current Rise Time vs Collector Current

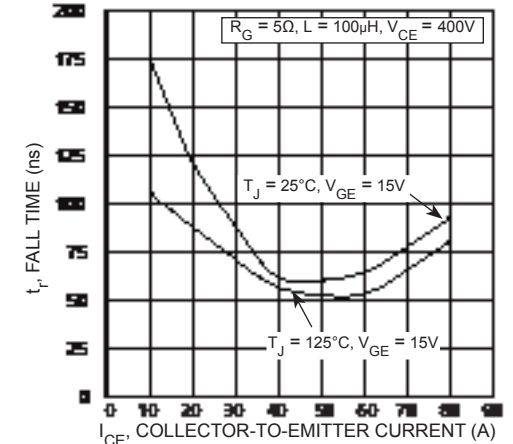

FIGURE 12, Current Fall Time vs Collector Current

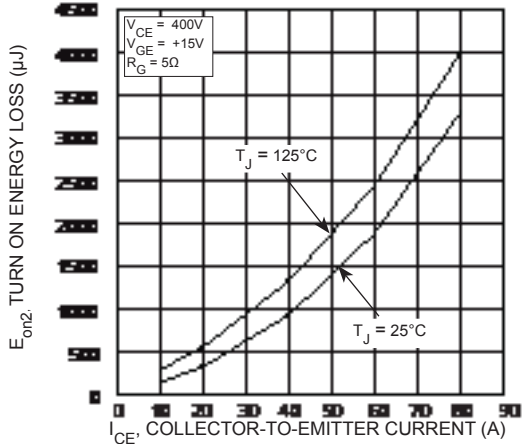

FIGURE 13, Turn-On Energy Loss vs Collector Current

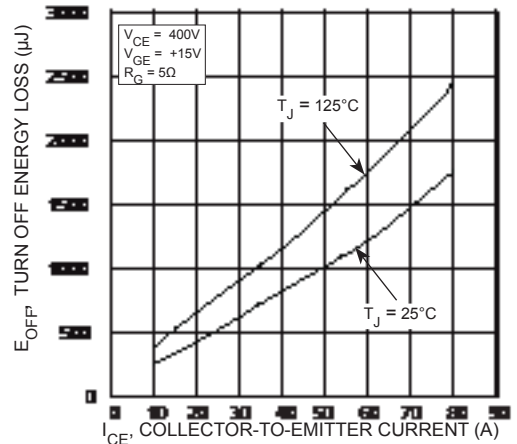

FIGURE 14, Turn-Off Energy Loss vs Collector Current

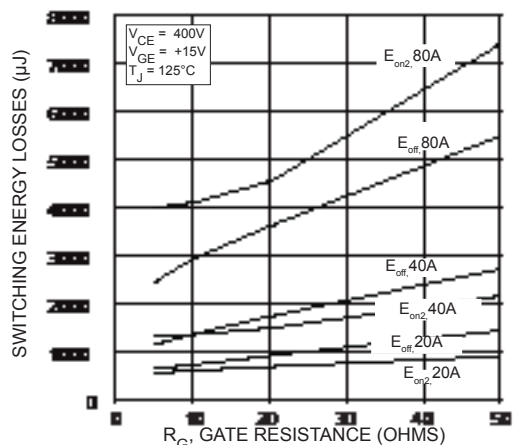

FIGURE 15, Switching Energy Losses vs Gate Resistance

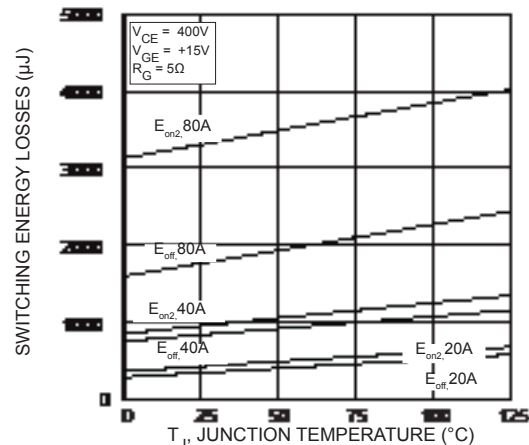
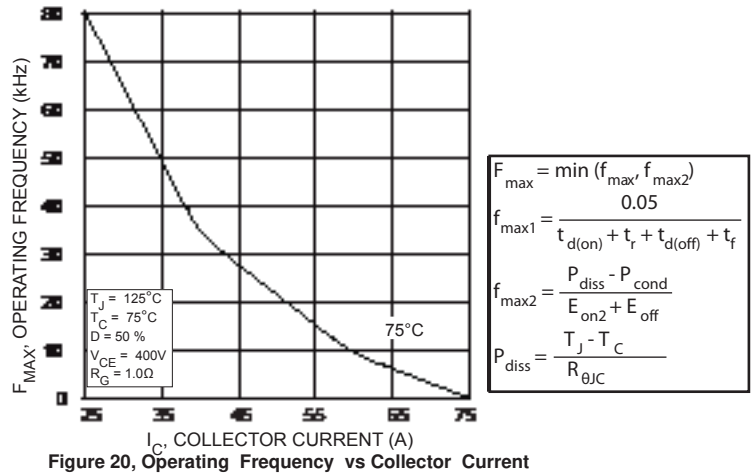
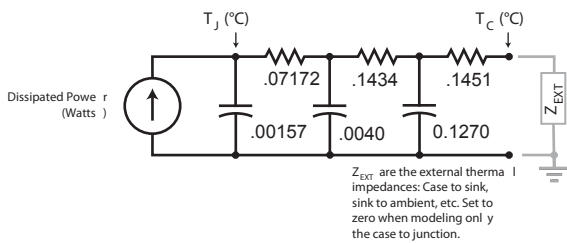
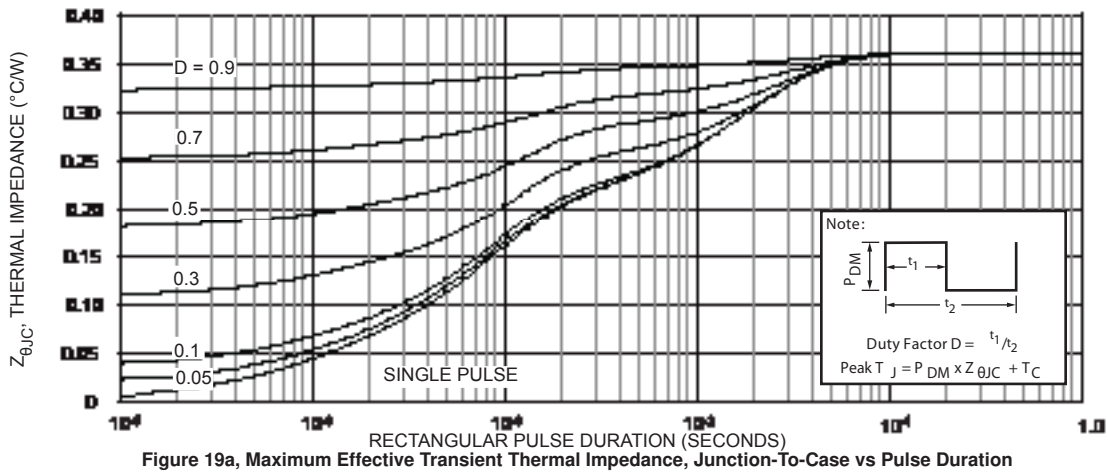
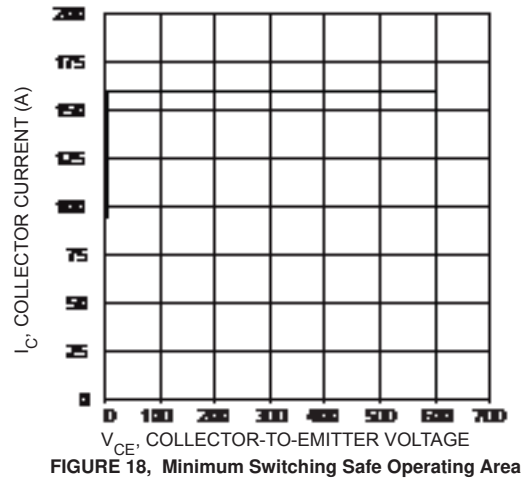
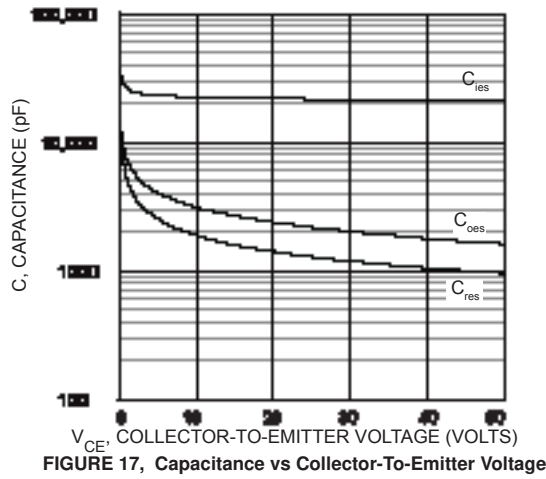

FIGURE 16, Switching Energy Losses vs Junction Temperature



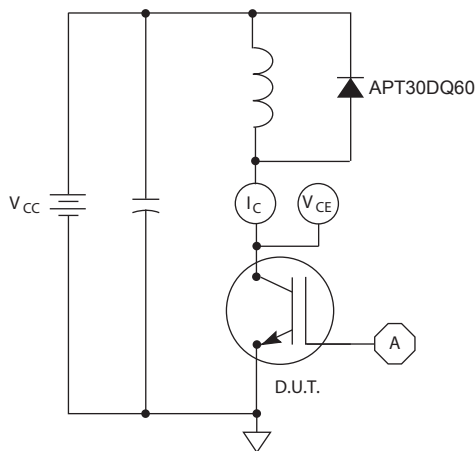

Figure 21, Inductive Switching Test Circuit

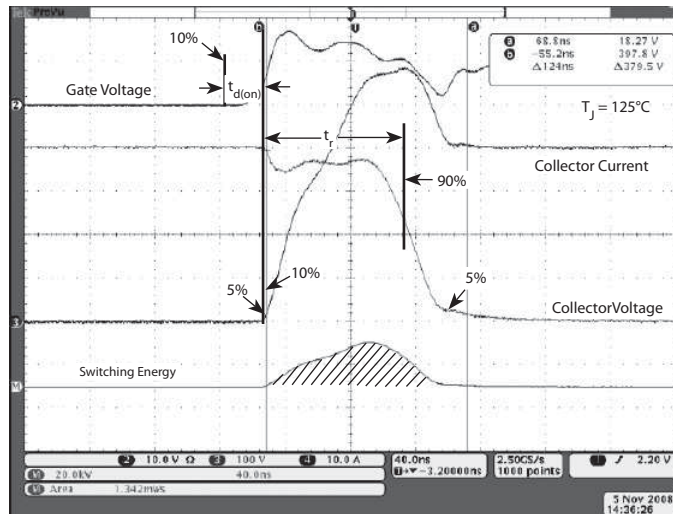

Figure 22, Turn-on Switching Waveforms and Definitions

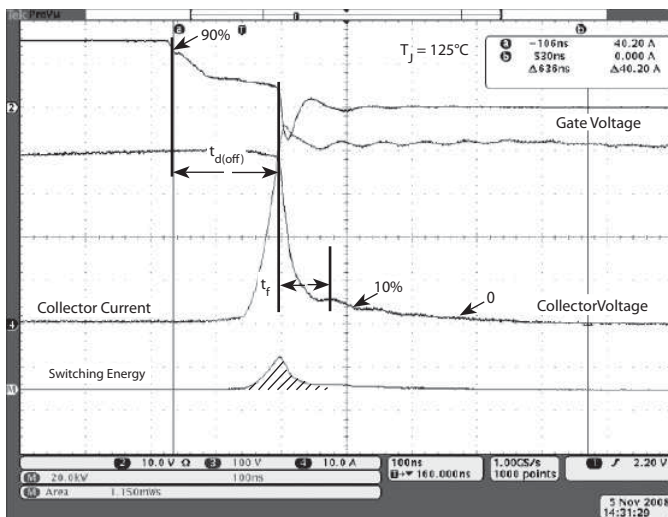
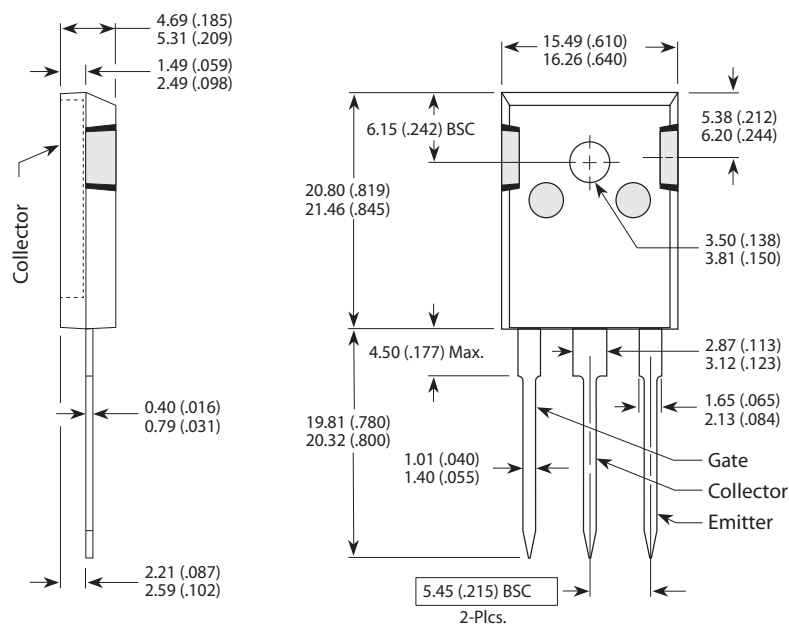

Figure 23, Turn-off Switching Waveforms and Definitions

TO-247 (B) Package Outline



Dimensions in Millimeters and (Inches)