



Chipsmall Limited consists of a professional team with an average of over 10 year of expertise in the distribution of electronic components. Based in Hongkong, we have already established firm and mutual-benefit business relationships with customers from,Europe,America and south Asia,supplying obsolete and hard-to-find components to meet their specific needs.

With the principle of "Quality Parts,Customers Priority,Honest Operation,and Considerate Service",our business mainly focus on the distribution of electronic components. Line cards we deal with include Microchip,ALPS,ROHM,Xilinx,Pulse,ON,Everlight and Freescale. Main products comprise IC,Modules,Potentiometer,IC Socket,Relay,Connector.Our parts cover such applications as commercial,industrial, and automotives areas.

We are looking forward to setting up business relationship with you and hope to provide you with the best service and solution. Let us make a better world for our industry!



## Contact us

Tel: +86-755-8981 8866 Fax: +86-755-8427 6832

Email & Skype: info@chipsmall.com Web: www.chipsmall.com

Address: A1208, Overseas Decoration Building, #122 Zhenhua RD., Futian, Shenzhen, China



## High Speed PT IGBT

POWER MOS 8® is a high speed Punch-Through switch-mode IGBT. Low  $E_{off}$  is achieved through leading technology silicon design and lifetime control processes. A reduced  $E_{off} - V_{CE(ON)}$  tradeoff results in superior efficiency compared to other IGBT technologies. Low gate charge and a greatly reduced ratio of  $C_{res}/C_{ies}$  provide excellent noise immunity, short delay times and simple gate drive. The intrinsic chip gate resistance and capacitance of the poly-silicone gate structure help control di/dt during switching, resulting in low EMI, even when switching at high frequency.

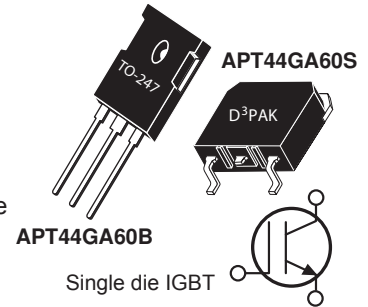

### FEATURES

- Fast switching with low EMI
- Very Low  $E_{off}$  for maximum efficiency
- Ultra low  $C_{res}$  for improved noise immunity
- Low conduction loss
- Low gate charge
- Increased intrinsic gate resistance for low EMI
- RoHS compliant 

### TYPICAL APPLICATIONS

- ZVS phase shifted and other full bridge
- Half bridge
- High power PFC boost
- Welding
- UPS, solar, and other inverters
- High frequency, high efficiency industrial

### Absolute Maximum Ratings

Symbol	Parameter	Ratings	Unit
$V_{CES}$	Collector Emitter Voltage	600	V
$I_{C1}$	Continuous Collector Current @ $T_c = 25^\circ\text{C}$	78	A
$I_{C2}$	Continuous Collector Current @ $T_c = 100^\circ\text{C}$	44	
$I_{CM}$	Pulsed Collector Current <sup>1</sup>	130	
$V_{GE}$	Gate-Emitter Voltage <sup>2</sup>	$\pm 30$	V
$P_D$	Total Power Dissipation @ $T_c = 25^\circ\text{C}$	337	W
SSOA	Switching Safe Operating Area @ $T_j = 150^\circ\text{C}$	130A @ 600V	
$T_J, T_{STG}$	Operating and Storage Junction Temperature Range	-55 to 150	°C
$T_L$	Lead Temperature for Soldering: 0.063" from Case for 10 Seconds	300	

### Static Characteristics

$T_J = 25^\circ\text{C}$  unless otherwise specified

Symbol	Parameter	Test Conditions	Min	Typ	Max	Unit
$V_{BR(CES)}$	Collector-Emitter Breakdown Voltage	$V_{GE} = 0V, I_C = 1.0mA$	600			V
$V_{CE(on)}$	Collector-Emitter On Voltage	$V_{GE} = 15V, I_C = 26A$		2.0	2.5	
		$T_J = 25^\circ\text{C}$ $T_J = 125^\circ\text{C}$		1.9		
$V_{GE(th)}$	Gate Emitter Threshold Voltage	$V_{GE} = V_{CE}, I_C = 1mA$	3	4.5	6	
$I_{CES}$	Zero Gate Voltage Collector Current	$V_{CE} = 600V, V_{GE} = 0V$			250	$\mu\text{A}$
		$T_J = 25^\circ\text{C}$ $T_J = 125^\circ\text{C}$			2500	
$I_{GES}$	Gate-Emitter Leakage Current	$V_{GS} = \pm 30V$			$\pm 100$	nA

### Thermal and Mechanical Characteristics

Symbol	Characteristic	Min	Typ	Max	Unit
$R_{\theta JC}$	Junction to Case Thermal Resistance	-	-	.37	°C/W
$W_T$	Package Weight	-	5.9	-	g
Torque	Mounting Torque (TO-247 Package), 4-40 or M3 screw			10	in·lbf

Dynamic Characteristics

T<sub>J</sub> = 25°C unless otherwise specified

APT44GA60B\_S

Symbol	Parameter	Test Conditions	Min	Typ	Max	Unit
C <sub>ies</sub>	Input Capacitance	Capacitance V <sub>GE</sub> = 0V, V <sub>CE</sub> = 25V f = 1MHz		3404		pF
C <sub>oes</sub>	Output Capacitance			358		
C <sub>res</sub>	Reverse Transfer Capacitance			43		
Q <sub>g</sub> <sup>3</sup>	Total Gate Charge	Gate Charge V <sub>GE</sub> = 15V V <sub>CE</sub> = 300V I <sub>C</sub> = 26A		128		nC
Q <sub>ge</sub>	Gate-Emitter Charge			22		
Q <sub>gc</sub>	Gate- Collector Charge			44		
SSOA	Switching Safe Operating Area	T <sub>J</sub> = 150°C, R <sub>G</sub> = 4.7Ω <sup>4</sup> , V <sub>GE</sub> = 15V, L = 100uH, V <sub>CE</sub> = 600V	130			A
t <sub>d(on)</sub>	Turn-On Delay Time	Inductive Switching (25°C) V <sub>CC</sub> = 400V V <sub>GE</sub> = 15V I <sub>C</sub> = 26A R <sub>G</sub> = 4.7Ω <sup>4</sup> T <sub>J</sub> = +25°C		16		ns
t <sub>r</sub>	Current Rise Time			14		
t <sub>d(off)</sub>	Turn-Off Delay Time			84		
t <sub>f</sub>	Current Fall Time			29		
E <sub>on2</sub>	Turn-On Switching Energy			409		
E <sub>off</sub> <sup>6</sup>	Turn-Off Switching Energy		258		μJ	
t <sub>d(on)</sub>	Turn-On Delay Time	Inductive Switching (125°C) V <sub>CC</sub> = 400V V <sub>GE</sub> = 15V I <sub>C</sub> = 26A R <sub>G</sub> = 4.7Ω <sup>4</sup> T <sub>J</sub> = +125°C		14		ns
t <sub>r</sub>	Current Rise Time			15		
t <sub>d(off)</sub>	Turn-Off Delay Time			109		
t <sub>f</sub>	Current Fall Time			99		
E <sub>on2</sub>	Turn-On Switching Energy			621		
E <sub>off</sub> <sup>6</sup>	Turn-Off Switching Energy			474		

1 Repetitive Rating: Pulse width and case temperature limited by maximum junction temperature.

2 Pulse test: Pulse Width < 380μs, duty cycle < 2%.

3 See Mil-Std-750 Method 3471

4 R<sub>G</sub> is external gate resistance, not including internal gate resistance or gate driver impedance. (MIC4452)

5 E<sub>on2</sub> is the clamped inductive turn on energy that includes a commutating diode reverse recovery current in the IGBT turn on energy loss. A combi device is used for the clamping diode.

6 E<sub>off</sub> is the clamped inductive turn-off energy measured in accordance with JEDEC standard JESD24-1.

Microsemi reserves the right to change, without notice, the specifications and information contained herein.



Typical Performance Curves

APT44GA60B\_S

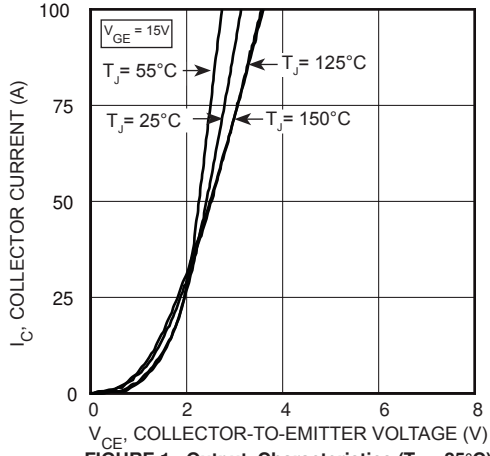

FIGURE 1, Output Characteristics ( $T_J = 25^\circ\text{C}$ )

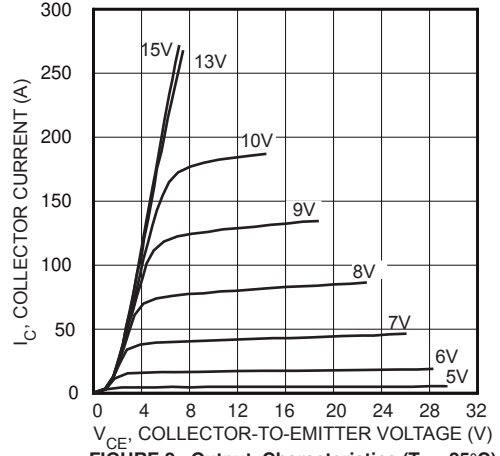

FIGURE 2, Output Characteristics ( $T_J = 25^\circ\text{C}$ )

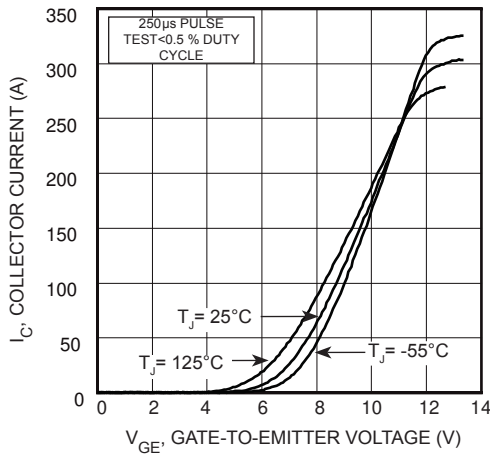

FIGURE 3, Transfer Characteristics

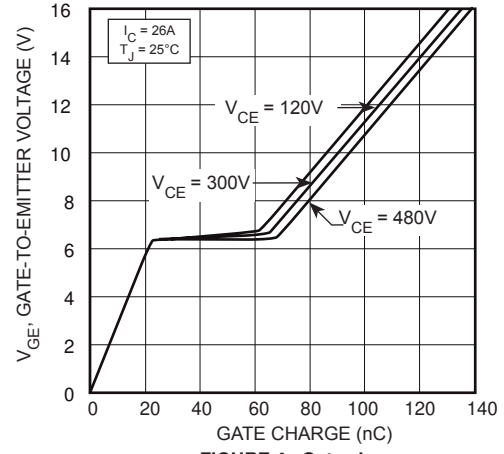

FIGURE 4, Gate charge

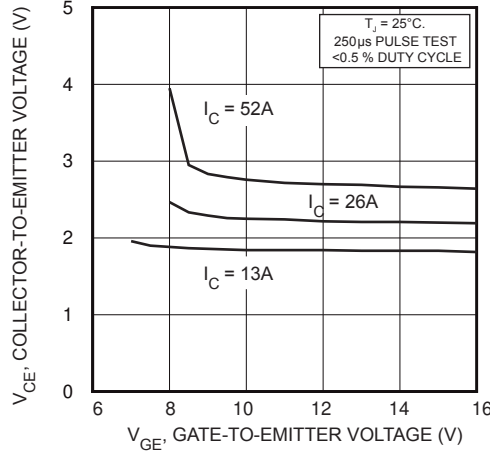

FIGURE 5, On State Voltage vs Gate-to-Emitter Voltage

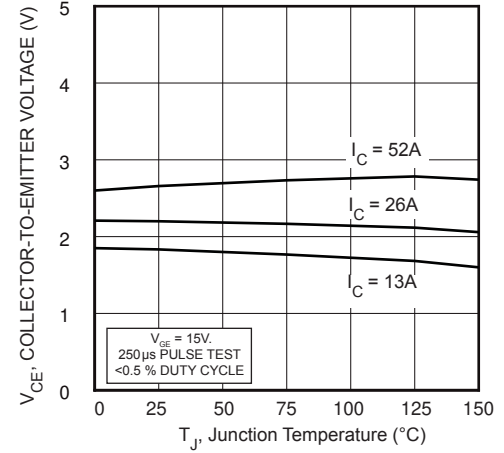

FIGURE 6, On State Voltage vs Junction Temperature

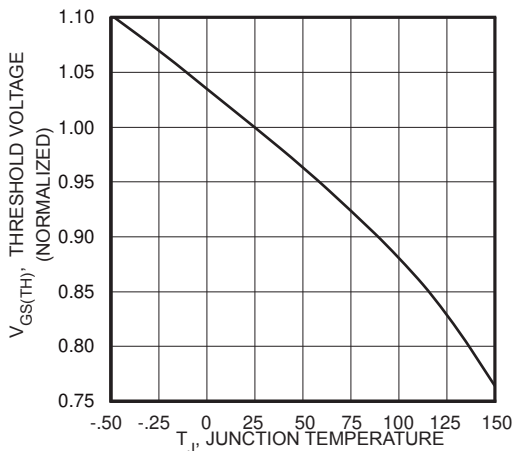

FIGURE 7, Threshold Voltage vs Junction Temperature

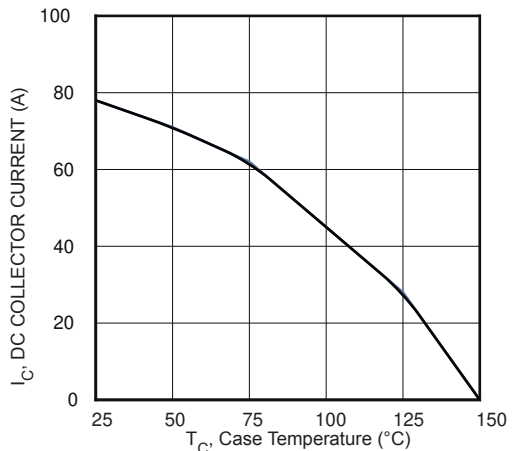

FIGURE 8, DC Collector Current vs Case Temperature

# Typical Performance Curves

APT44GA60B\_S

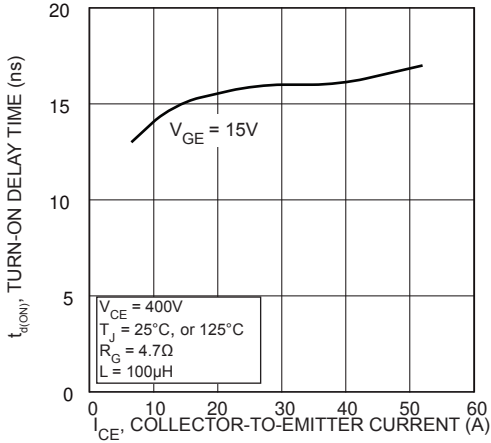

FIGURE 9, Turn-On Delay Time vs Collector Current

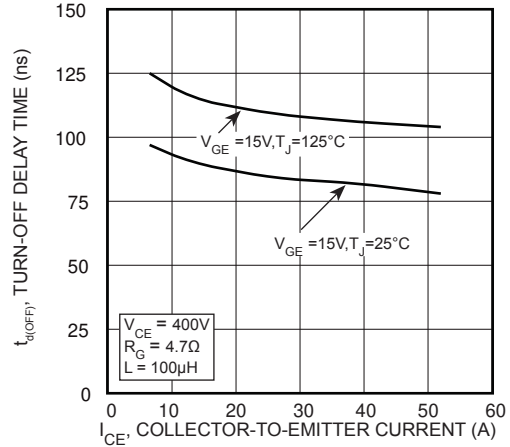

FIGURE 10, Turn-Off Delay Time vs Collector Current

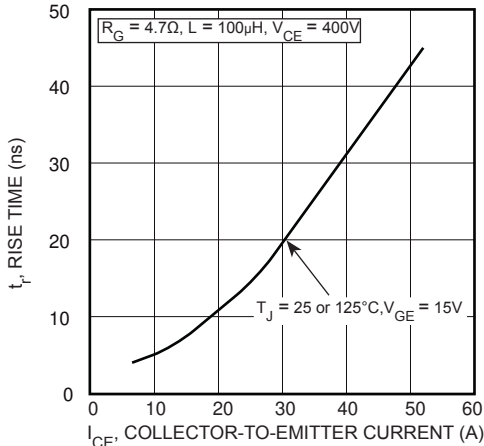

FIGURE 11, Current Rise Time vs Collector Current

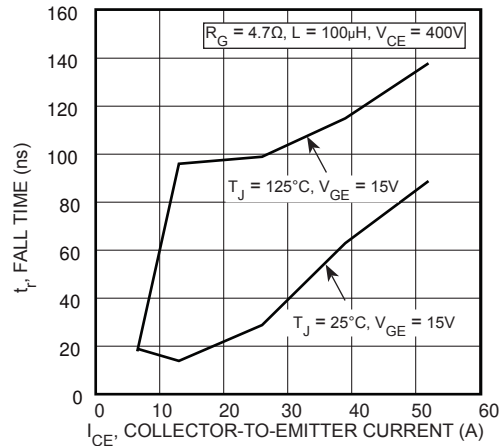

FIGURE 12, Current Fall Time vs Collector Current

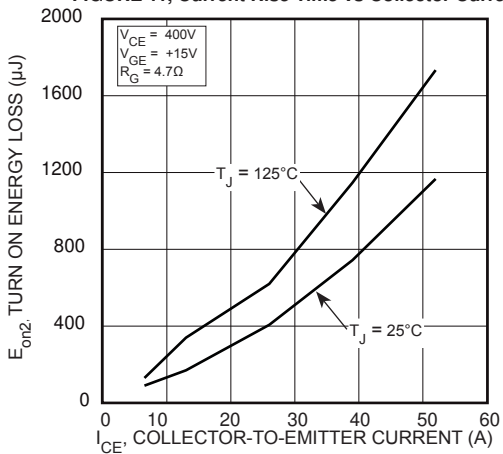

FIGURE 13, Turn-On Energy Loss vs Collector Current

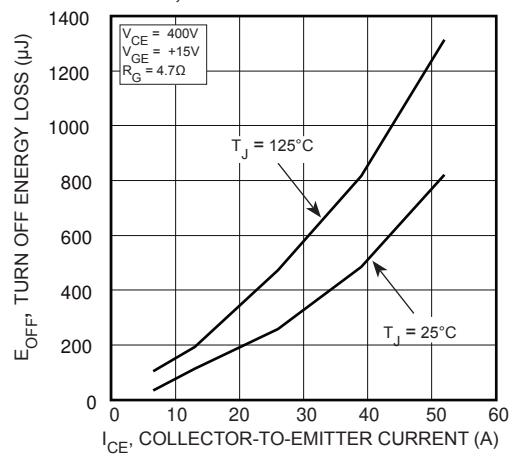

FIGURE 14, Turn-Off Energy Loss vs Collector Current

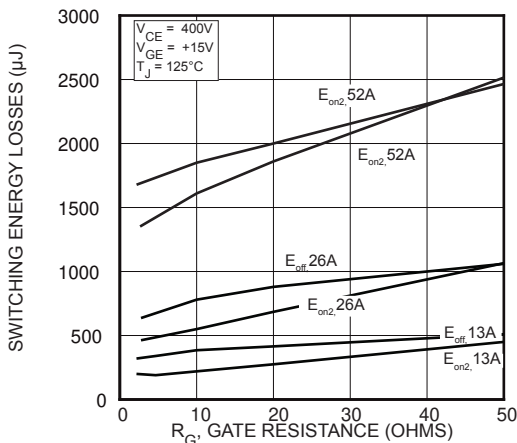

FIGURE 15, Switching Energy Losses vs Gate Resistance

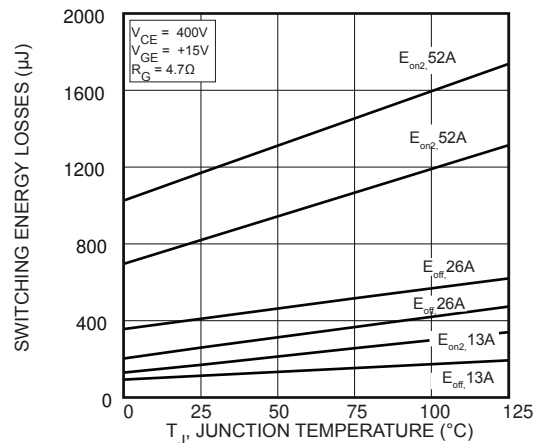

FIGURE 16, Switching Energy Losses vs Junction Temperature

# Typical Performance Curves

APT44GA60B\_S

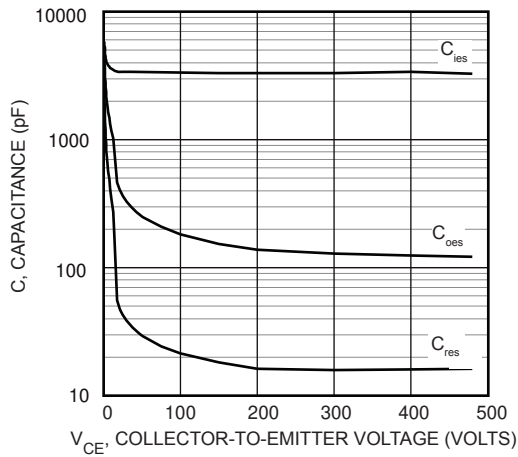

FIGURE 17, Capacitance vs Collector-To-Emitter Voltage

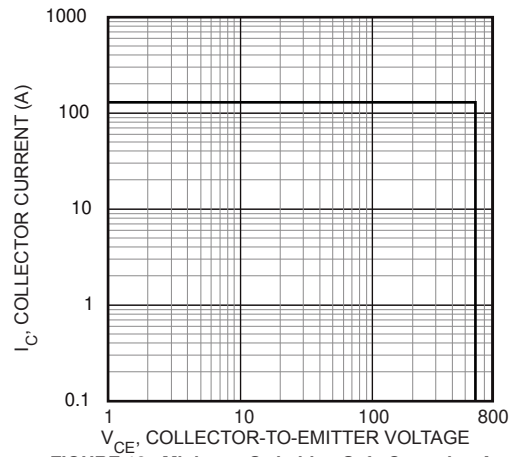

FIGURE 18, Minimum Switching Safe Operating Area

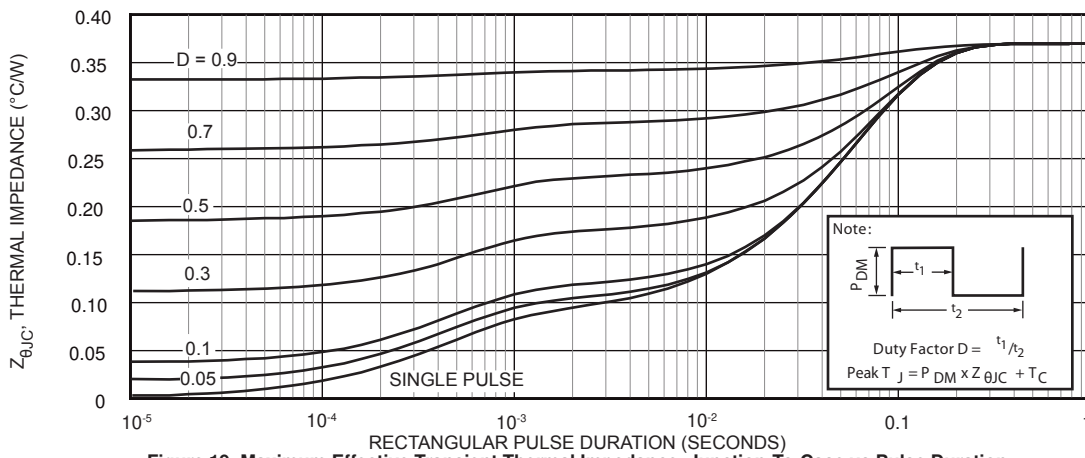

Figure 19, Maximum Effective Transient Thermal Impedance, Junction-To-Case vs Pulse Duration

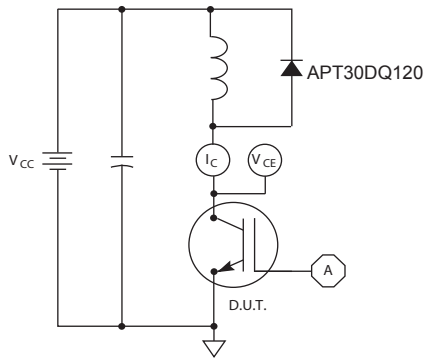

Figure 20, Inductive Switching Test Circuit

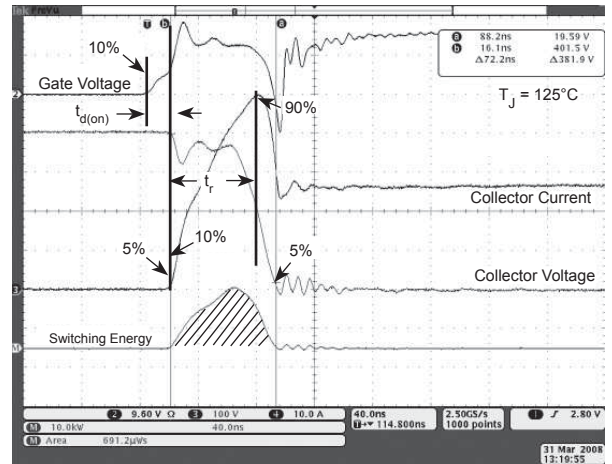

Figure 21, Turn-on Switching Waveforms and Definitions

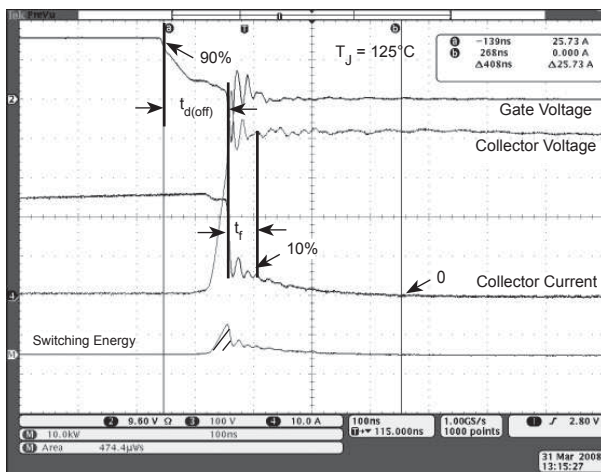
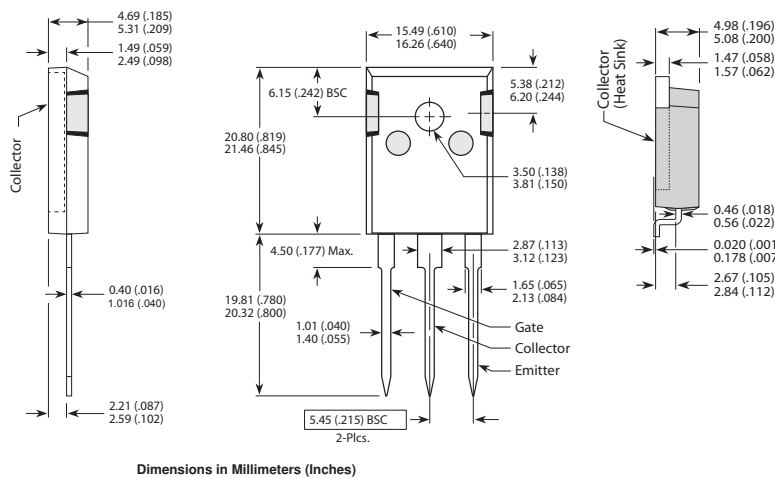

Figure 22, Turn-off Switching Waveforms and Definitions

### TO-247 Package Outline

Ⓔ1 SAC: Tin, Silver, Copper



### D<sup>3</sup>PAK Package Outline

Ⓔ3 100% Sn Plated

