



Chipsmall Limited consists of a professional team with an average of over 10 year of expertise in the distribution of electronic components. Based in Hongkong, we have already established firm and mutual-benefit business relationships with customers from,Europe,America and south Asia,supplying obsolete and hard-to-find components to meet their specific needs.

With the principle of "Quality Parts,Customers Priority,Honest Operation,and Considerate Service",our business mainly focus on the distribution of electronic components. Line cards we deal with include Microchip,ALPS,ROHM,Xilinx,Pulse,ON,Everlight and Freescale. Main products comprise IC,Modules,Potentiometer,IC Socket,Relay,Connector.Our parts cover such applications as commercial,industrial, and automotives areas.

We are looking forward to setting up business relationship with you and hope to provide you with the best service and solution. Let us make a better world for our industry!



Contact us

Tel: +86-755-8981 8866 Fax: +86-755-8427 6832

Email & Skype: info@chipsmall.com Web: www.chipsmall.com

Address: A1208, Overseas Decoration Building, #122 Zhenhua RD., Futian, Shenzhen, China



FAST IGBT & FRED

The Fast IGBT is a new generation of high voltage power IGBTs. Using Non-Punch through technology, the Fast IGBT combined with an APT free wheeling Ultra Fast Recovery Epitaxial Diode (FRED) offers superior ruggedness and fast switching speed.

- Low Forward Voltage Drop
- High Freq. Switching to 20KHz
- RBSOA and SCSOA Rated
- Ultra Low Leakage Current
- Ultrafast Soft Recovery Anti-parallel Diode

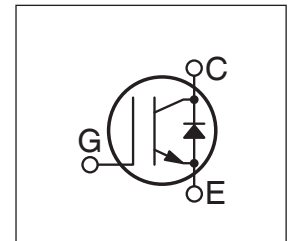

MAXIMUM RATINGS

All Ratings: $T_C = 25^\circ\text{C}$ unless otherwise specified.

Symbol	Parameter	APT50GF120JRDQ3	UNIT
V_{CES}	Collector-Emitter Voltage	1200	Volts
V_{GE}	Gate-Emitter Voltage	± 30	
I_{C1}	Continuous Collector Current @ $T_C = 25^\circ\text{C}$	120	Amps
I_{C2}	Continuous Collector Current @ $T_C = 100^\circ\text{C}$	64	
I_{CM}	Pulsed Collector Current ^①	225	
SSOA	Switching Safe Operating Area @ $T_J = 150^\circ\text{C}$	225A @ 1200V	
P_D	Total Power Dissipation	521	Watts
T_J, T_{STG}	Operating and Storage Junction Temperature Range	-55 to 150	$^\circ\text{C}$
T_L	Max. Lead Temp. for Soldering: 0.063" from Case for 10 Sec.	300	

STATIC ELECTRICAL CHARACTERISTICS

Symbol	Characteristic / Test Conditions	MIN	TYP	MAX	Units
$V_{(BR)CES}$	Collector-Emitter Breakdown Voltage ($V_{GE} = 0V, I_C = 750\mu\text{A}$)	1200			Volts
$V_{GE(TH)}$	Gate Threshold Voltage ($V_{CE} = V_{GE}, I_C = 700\mu\text{A}, T_J = 25^\circ\text{C}$)	4.5	5.5	6.5	
$V_{CE(ON)}$	Collector-Emitter On Voltage ($V_{GE} = 15V, I_C = 75A, T_J = 25^\circ\text{C}$)		2.5	3.0	
	Collector-Emitter On Voltage ($V_{GE} = 15V, I_C = 75A, T_J = 125^\circ\text{C}$)		3.1		
I_{CES}	Collector Cut-off Current ($V_{CE} = 1200V, V_{GE} = 0V, T_J = 25^\circ\text{C}$) ^②			0.75	mA
	Collector Cut-off Current ($V_{CE} = 1200V, V_{GE} = 0V, T_J = 125^\circ\text{C}$) ^②			5.5	
I_{GES}	Gate-Emitter Leakage Current ($V_{GE} = \pm 20V$)			± 100	nA

 **CAUTION:** These Devices are Sensitive to Electrostatic Discharge. Proper Handling Procedures Should Be Followed.

DYNAMIC CHARACTERISTICS

APT50GF120JRDQ3

Symbol	Characteristic	Test Conditions	MIN	TYP	MAX	UNIT	
C_{ies}	Input Capacitance	Capacitance $V_{GE} = 0V, V_{CE} = 25V$ $f = 1 \text{ MHz}$		5320		pF	
C_{oes}	Output Capacitance			555			
C_{res}	Reverse Transfer Capacitance			300			
V_{GEP}	Gate-to-Emitter Plateau Voltage	Gate Charge		10.0		V	
Q_g	Total Gate Charge ^③	$V_{GE} = 15V$ $V_{CE} = 600V$ $I_C = 75A$		495		nC	
Q_{ge}	Gate-Emitter Charge			50			
Q_{gc}	Gate-Collector ("Miller") Charge			290			
SSOA	Switching Safe Operating Area	$T_J = 150^\circ\text{C}, R_G = 1.0\Omega, V_{GE} = 15V, L = 100\mu\text{H}, V_{CE} = 1200V$	225			A	
$t_{d(on)}$	Turn-on Delay Time	Inductive Switching (25°C) $V_{CC} = 800V$ $V_{GE} = 15V$ $I_C = 75A$ $R_G = 1.0\Omega$ $T_J = +25^\circ\text{C}$		36		ns	
t_r	Current Rise Time			70			
$t_{d(off)}$	Turn-off Delay Time			355			
t_f	Current Fall Time			65			
E_{on1}	Turn-on Switching Energy ^④			7965			μJ
E_{on2}	Turn-on Switching Energy (Diode) ^⑤		9895				
E_{off}	Turn-off Switching Energy ^⑥		4340				
$t_{d(on)}$	Turn-on Delay Time	Inductive Switching (125°C) $V_{CC} = 800V$ $V_{GE} = 15V$ $I_C = 75A$ $R_G = 1.0\Omega$ $T_J = +125^\circ\text{C}$		36		ns	
t_r	Current Rise Time			70			
$t_{d(off)}$	Turn-off Delay Time			410			
t_f	Current Fall Time			110			
E_{on1}	Turn-on Switching Energy ^④			7890			μJ
E_{on2}	Turn-on Switching Energy (Diode) ^⑤			14110			
E_{off}	Turn-off Switching Energy ^⑥		6040				

THERMAL AND MECHANICAL CHARACTERISTICS

Symbol	Characteristic	MIN	TYP	MAX	UNIT
$R_{\theta JC}$	Junction to Case (IGBT)			.24	°C/W
$R_{\theta JC}$	Junction to Case (DIODE)			.56	
W_T	Package Weight		29.2		gm
$V_{Isolation}$	RMS Voltage (50-60Hz Sinusoidal Waveform From Terminals to Mounting Base for 1 Min.)	2500			Volts

- ① Repetitive Rating: Pulse width limited by maximum junction temperature.
- ② For Combi devices, I_{ces} includes both IGBT and FRED leakages
- ③ See MIL-STD-750 Method 3471.
- ④ E_{on1} is the clamped inductive turn-on energy of the IGBT only, without the effect of a commutating diode reverse recovery current adding to the IGBT turn-on loss. Tested in inductive switching test circuit shown in figure 21, but with a Silicon Carbide diode.
- ⑤ E_{on2} is the clamped inductive turn-on energy that includes a commutating diode reverse recovery current in the IGBT turn-on switching loss. (See Figures 21, 22.)
- ⑥ E_{off} is the clamped inductive turn-off energy measured in accordance with JEDEC standard JESD24-1. (See Figures 21, 23.)

APT Reserves the right to change, without notice, the specifications and information contained herein.

TYPICAL PERFORMANCE CURVES

APT50GF120JRDQ3

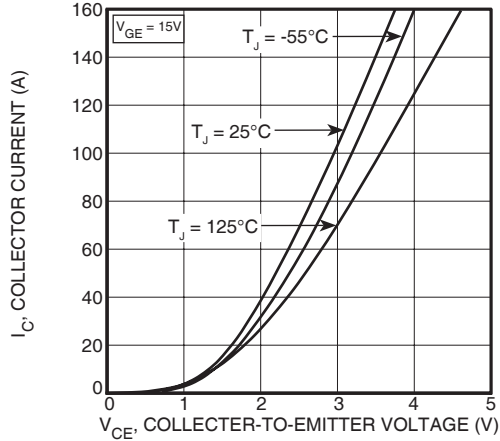

FIGURE 1, Output Characteristics($T_J = 25^\circ\text{C}$)

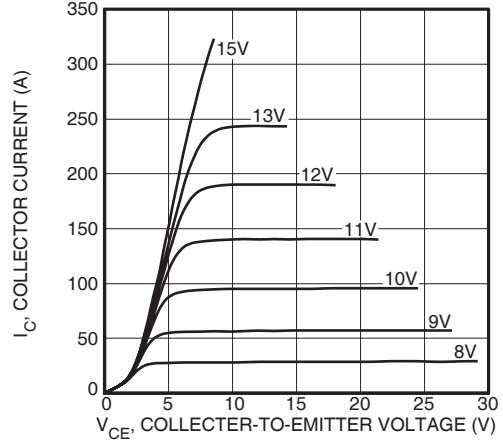

FIGURE 2, Output Characteristics ($T_J = 125^\circ\text{C}$)

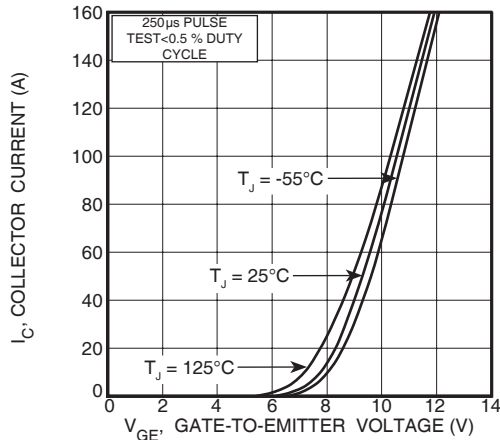

FIGURE 3, Transfer Characteristics

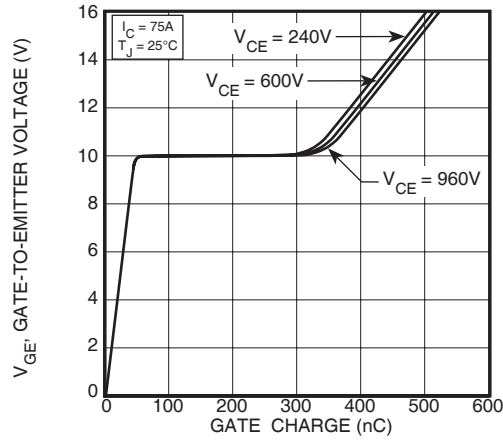

FIGURE 4, Gate Charge

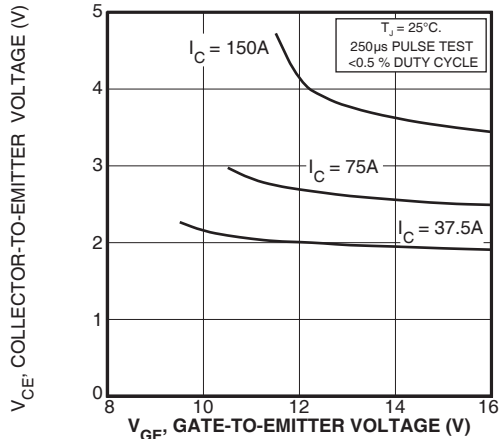

FIGURE 5, On State Voltage vs Gate-to-Emitter Voltage

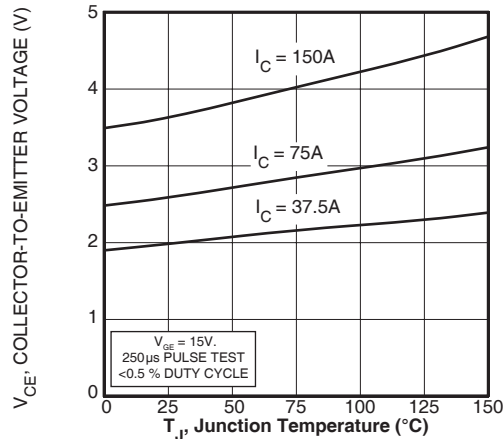

FIGURE 6, On State Voltage vs Junction Temperature

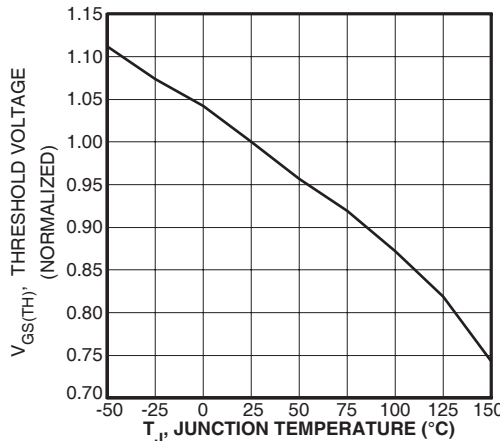

FIGURE 7, Threshold Voltage vs. Junction Temperature

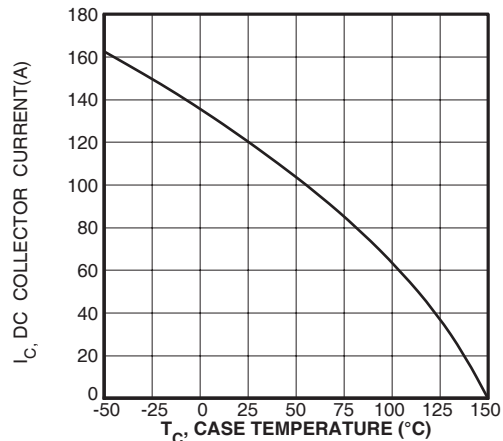

FIGURE 8, DC Collector Current vs Case Temperature

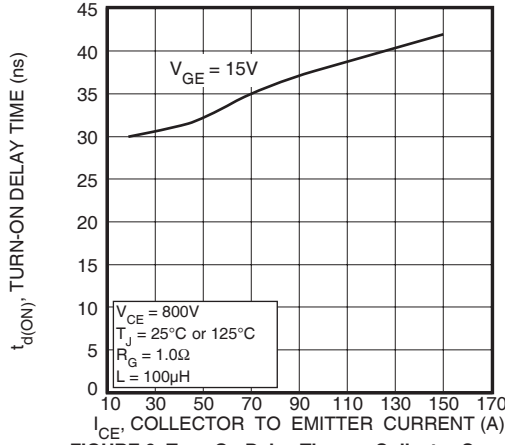

FIGURE 9, Turn-On Delay Time vs Collector Current

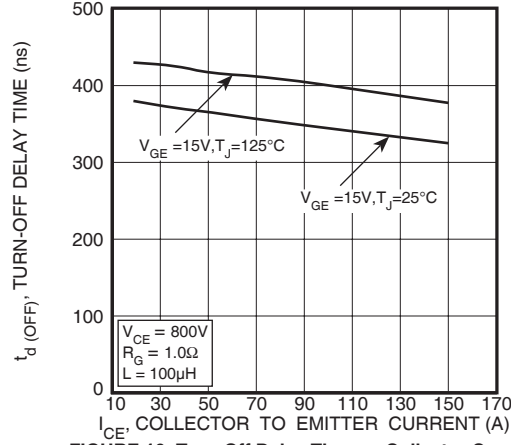

FIGURE 10, Turn-Off Delay Time vs Collector Current

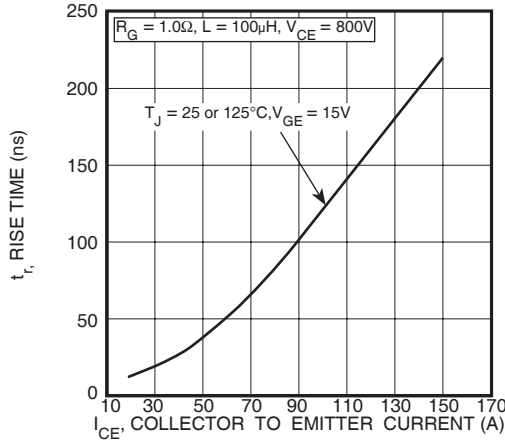

FIGURE 11, Current Rise Time vs Collector Current

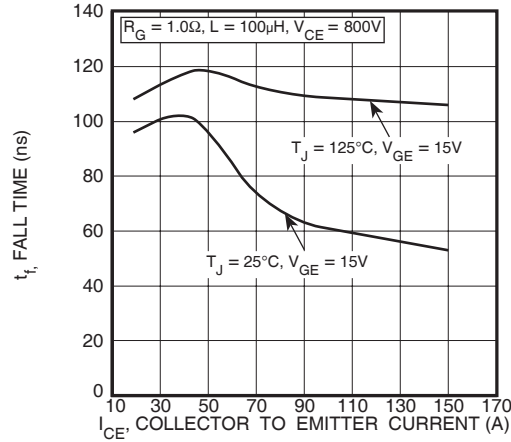

FIGURE 12, Current Fall Time vs Collector Current

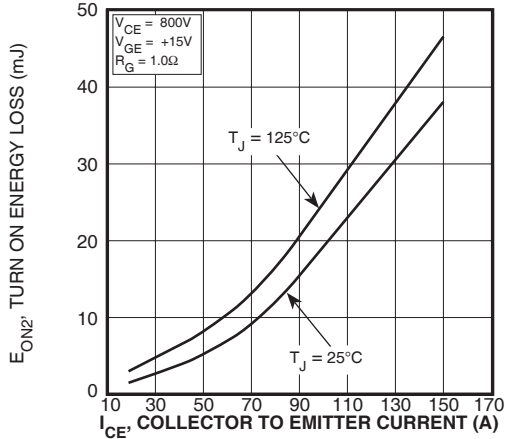

FIGURE 13, Turn-On Energy Loss vs Collector Current

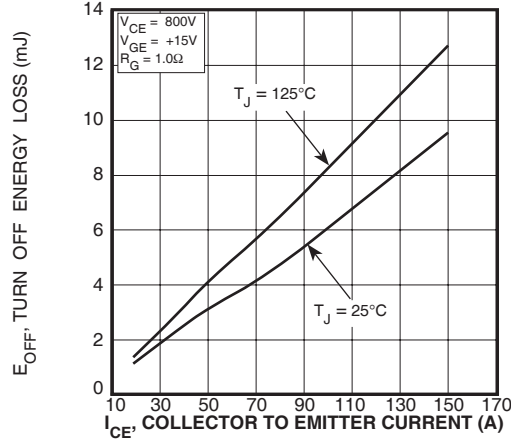

FIGURE 14, Turn Off Energy Loss vs Collector Current

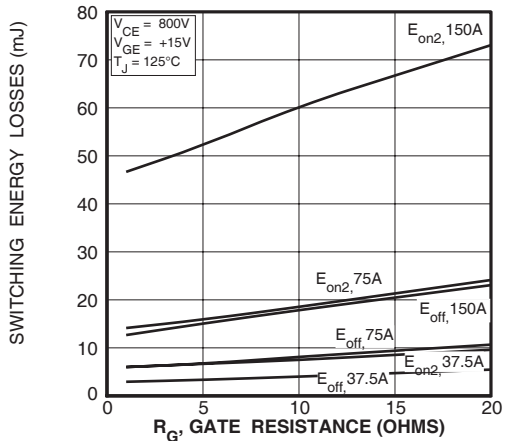

FIGURE 15, Switching Energy Losses vs. Gate Resistance

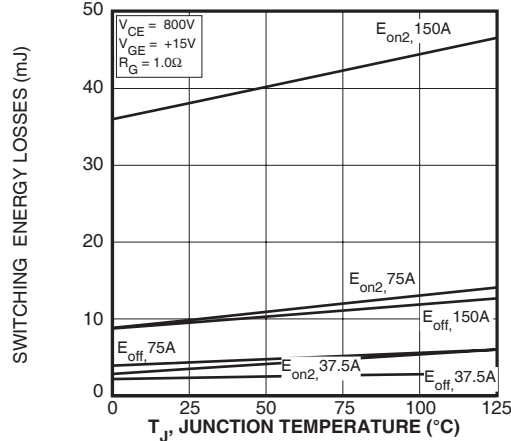

FIGURE 16, Switching Energy Losses vs Junction Temperature

TYPICAL PERFORMANCE CURVES

APT50GF120JRDQ3

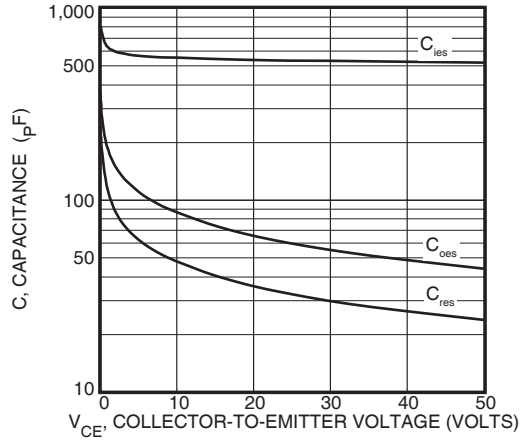

Figure 17, Capacitance vs Collector-To-Emitter Voltage

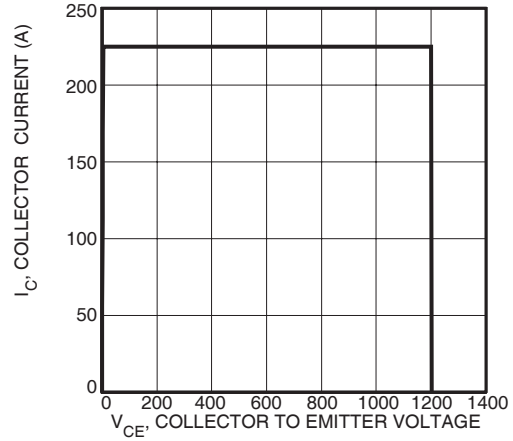

Figure 18, Minimum Switching Safe Operating Area

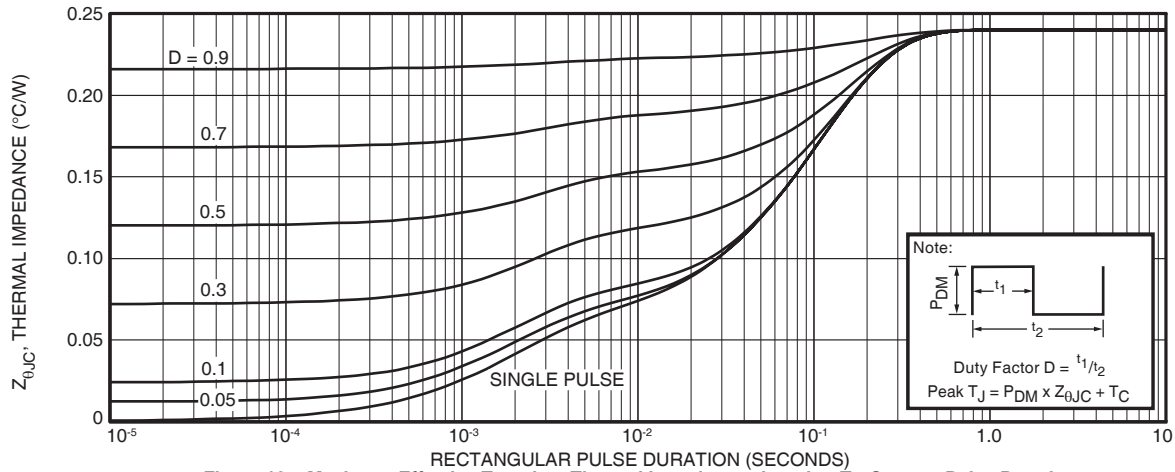

Figure 19a, Maximum Effective Transient Thermal Impedance, Junction-To-Case vs Pulse Duration

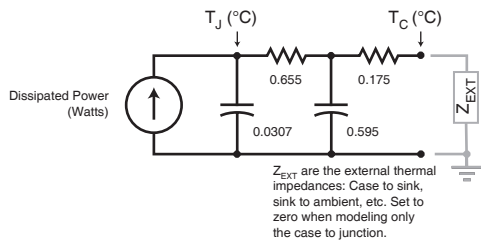

FIGURE 19b, TRANSIENT THERMAL IMPEDANCE MODEL

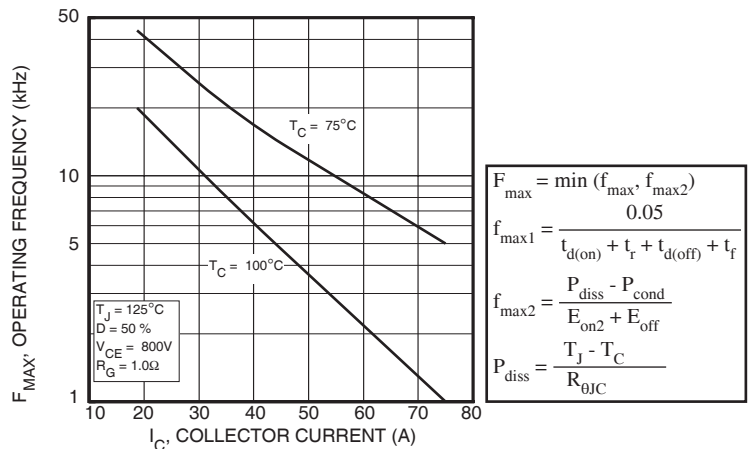

Figure 20, Operating Frequency vs Collector Current

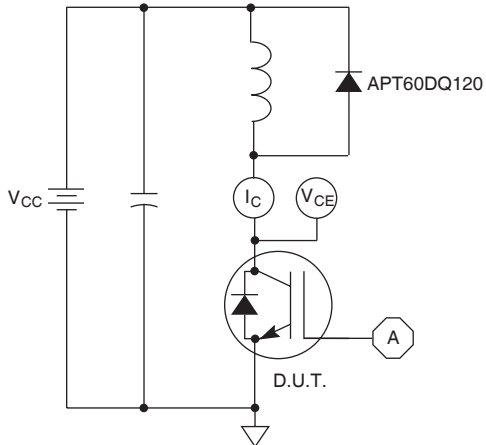

Figure 21, Inductive Switching Test Circuit

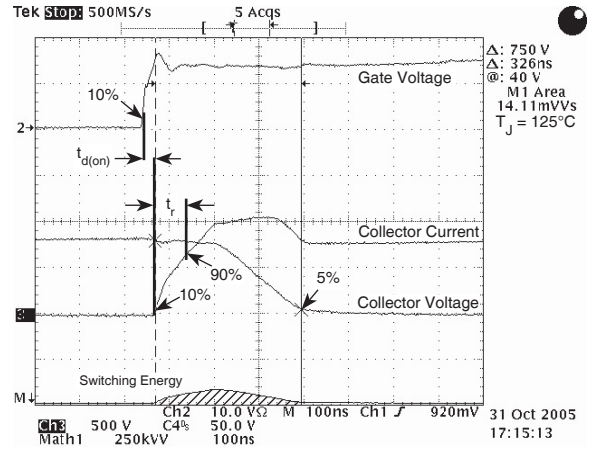

Figure 22, Turn-on Switching Waveforms and Definitions

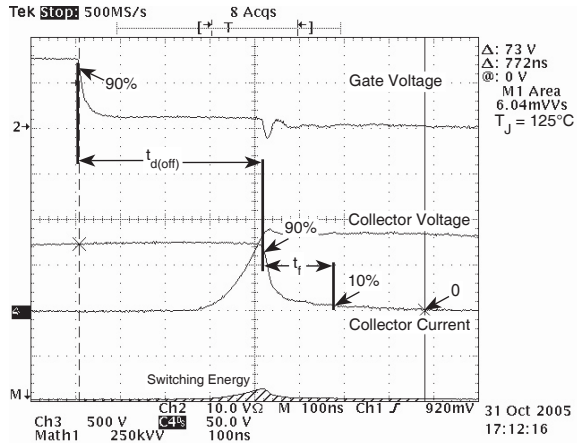

Figure 23, Turn-off Switching Waveforms and Definitions

ULTRAFAST SOFT RECOVERY ANTI-PARALLEL DIODE

MAXIMUM RATINGS

All Ratings: $T_C = 25^\circ\text{C}$ unless otherwise specified.

Symbol	Characteristic / Test Conditions	APT50GF120JRDQ3		UNIT
$I_F(\text{AV})$	Maximum Average Forward Current ($T_C = 85^\circ\text{C}$, Duty Cycle = 0.5)		60	Amps
$I_F(\text{RMS})$	RMS Forward Current (Square wave, 50% duty)		73	
I_{FSM}	Non-Repetitive Forward Surge Current ($T_J = 45^\circ\text{C}$, 8.3ms)		540	

STATIC ELECTRICAL CHARACTERISTICS

Symbol	Characteristic / Test Conditions	MIN	TYP	MAX	UNIT
V_F	Forward Voltage		$I_F = 75\text{A}$	2.8	Volts
			$I_F = 150\text{A}$	3.48	
			$I_F = 75\text{A}, T_J = 125^\circ\text{C}$	2.17	

DYNAMIC CHARACTERISTICS

Symbol	Characteristic	Test Conditions	MIN	TYP	MAX	UNIT
t_{rr}	Reverse Recovery Time	$I_F = 1\text{A}, di_F/dt = -100\text{A}/\mu\text{s}, V_R = 30\text{V}, T_J = 25^\circ\text{C}$	-	60	-	ns
t_{rr}	Reverse Recovery Time	$I_F = 60\text{A}, di_F/dt = -200\text{A}/\mu\text{s}, V_R = 800\text{V}, T_C = 25^\circ\text{C}$	-	265	-	
Q_{rr}	Reverse Recovery Charge		-	560	-	nC
I_{RRM}	Maximum Reverse Recovery Current		-	5	-	Amps
t_{rr}	Reverse Recovery Time	$I_F = 60\text{A}, di_F/dt = -200\text{A}/\mu\text{s}, V_R = 800\text{V}, T_C = 125^\circ\text{C}$	-	350	-	ns
Q_{rr}	Reverse Recovery Charge		-	2890	-	nC
I_{RRM}	Maximum Reverse Recovery Current		-	13	-	Amps
t_{rr}	Reverse Recovery Time	$I_F = 60\text{A}, di_F/dt = -1000\text{A}/\mu\text{s}, V_R = 800\text{V}, T_C = 125^\circ\text{C}$	-	150	-	ns
Q_{rr}	Reverse Recovery Charge		-	4720	-	nC
I_{RRM}	Maximum Reverse Recovery Current		-	40	-	Amps

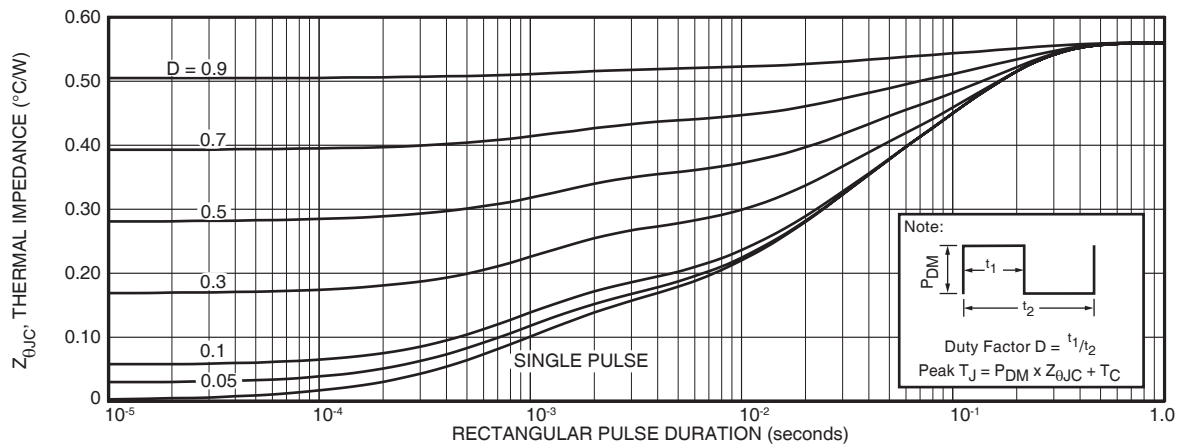
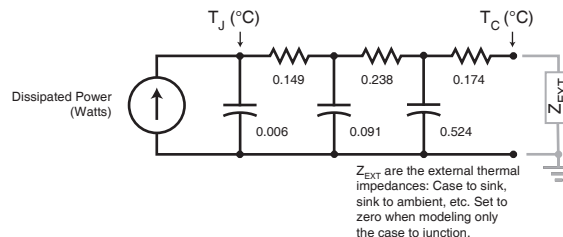

FIGURE 24a. MAXIMUM EFFECTIVE TRANSIENT THERMAL IMPEDANCE, JUNCTION-TO-CASE vs. PULSE DURATION



Z_{EXT} are the external thermal impedances: Case to sink, sink to ambient, etc. Set to zero when modeling only the case to junction.

FIGURE 24b. TRANSIENT THERMAL IMPEDANCE MODEL

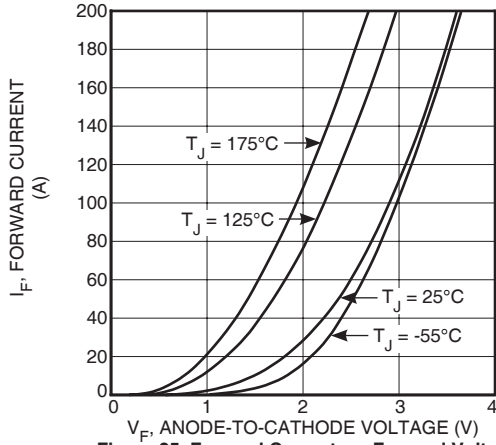

Figure 25. Forward Current vs. Forward Voltage

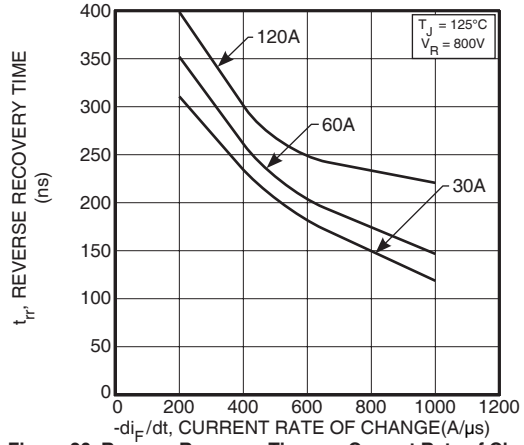

Figure 26. Reverse Recovery Time vs. Current Rate of Change

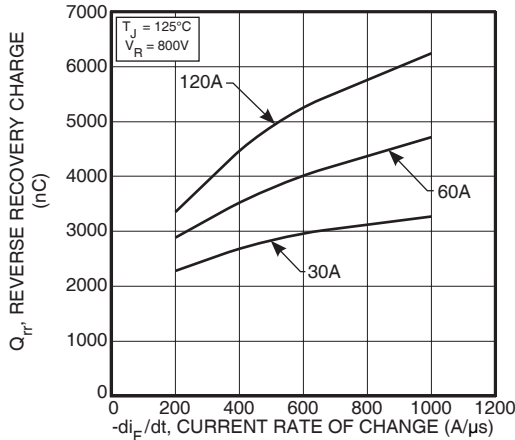

Figure 27. Reverse Recovery Charge vs. Current Rate of Change

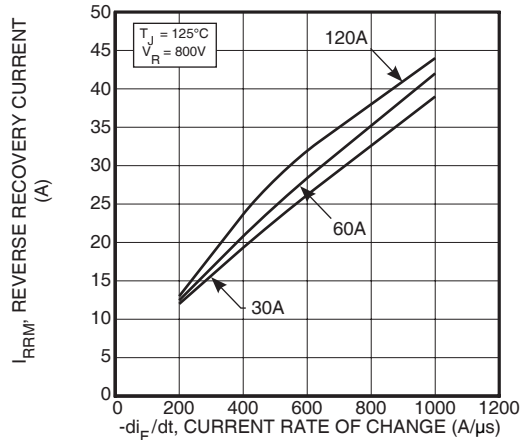

Figure 28. Reverse Recovery Current vs. Current Rate of Change

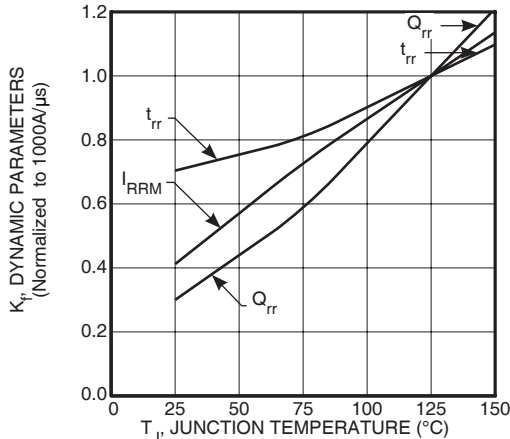

Figure 29. Dynamic Parameters vs. Junction Temperature

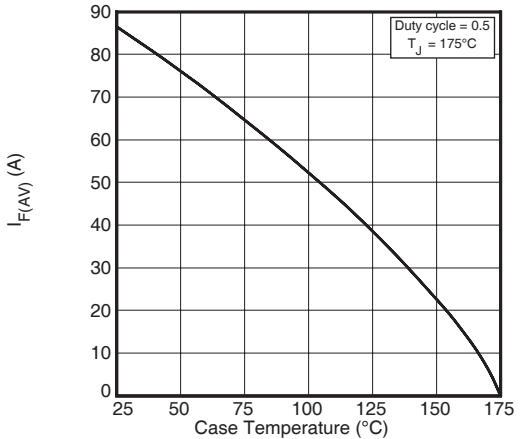

Figure 30. Maximum Average Forward Current vs. Case Temperature

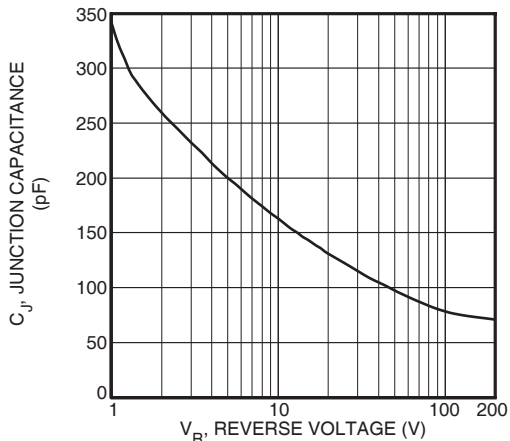

Figure 31. Junction Capacitance vs. Reverse Voltage

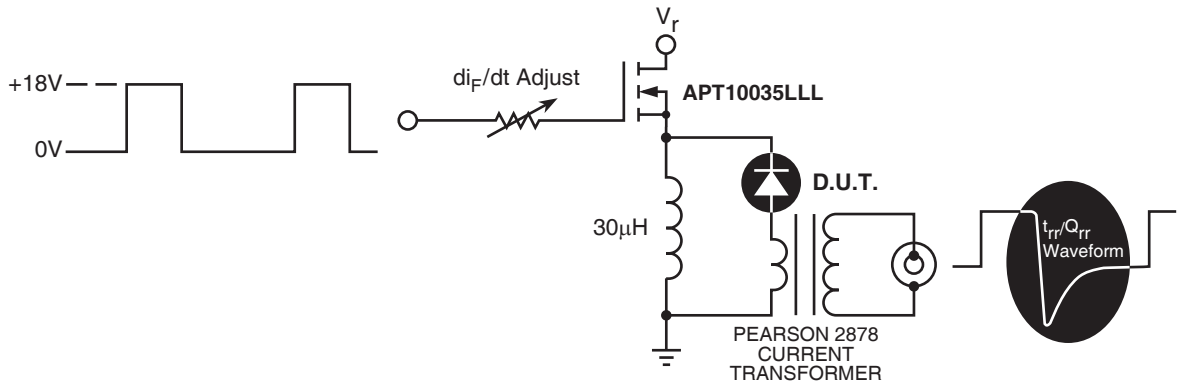

Figure 32. Diode Test Circuit

- 1 I_F - Forward Conduction Current
- 2 di_F/dt - Rate of Diode Current Change Through Zero Crossing.
- 3 I_{RRM} - Maximum Reverse Recovery Current.
- 4 t_{rr} - Reverse Recovery Time, measured from zero crossing where diode current goes from positive to negative, to the point at which the straight line through I_{RRM} and $0.25 \cdot I_{RRM}$ passes through zero.
- 5 Q_{rr} - Area Under the Curve Defined by I_{RRM} and t_{rr} .

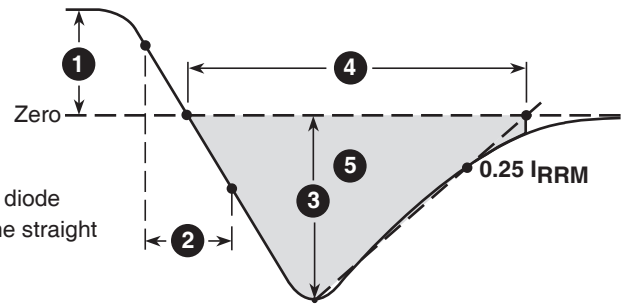
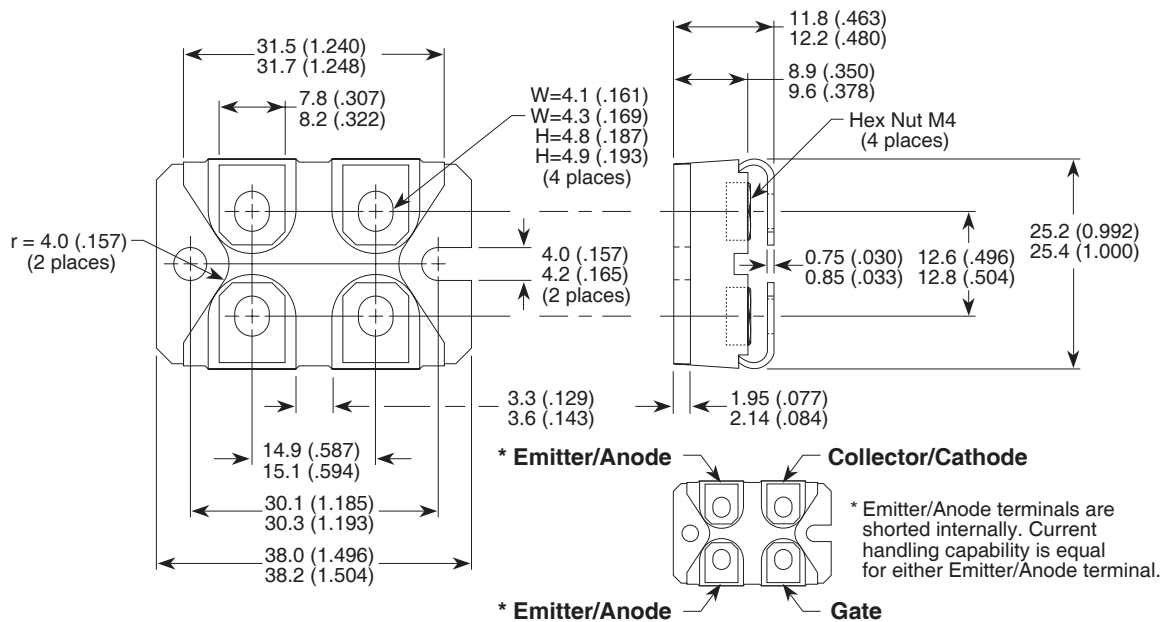

Figure 33. Diode Reverse Recovery Waveform and Definitions

SOT-227 (ISOTOP®) Package Outline



Dimensions in Millimeters and (Inches)