



Chipsmall Limited consists of a professional team with an average of over 10 year of expertise in the distribution of electronic components. Based in Hongkong, we have already established firm and mutual-benefit business relationships with customers from,Europe,America and south Asia,supplying obsolete and hard-to-find components to meet their specific needs.

With the principle of “Quality Parts,Customers Priority,Honest Operation,and Considerate Service”,our business mainly focus on the distribution of electronic components. Line cards we deal with include Microchip,ALPS,ROHM,Xilinx,Pulse,ON,Everlight and Freescale. Main products comprise IC,Modules,Potentiometer,IC Socket,Relay,Connector.Our parts cover such applications as commercial,industrial, and automotives areas.

We are looking forward to setting up business relationship with you and hope to provide you with the best service and solution. Let us make a better world for our industry!



Contact us

Tel: +86-755-8981 8866 Fax: +86-755-8427 6832

Email & Skype: info@chipsmall.com Web: www.chipsmall.com

Address: A1208, Overseas Decoration Building, #122 Zhenhua RD., Futian, Shenzhen, China

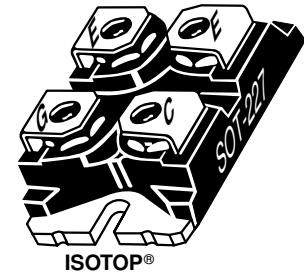

POWER MOS 7® IGBT

The POWER MOS 7® IGBT is a new generation of high voltage power IGBTs. Using Punch Through Technology this IGBT is ideal for many high frequency, high voltage switching applications and has been optimized for high frequency switchmode power supplies.

- **Low Conduction Loss**
- **Low Gate Charge**
- **Ultrafast Tail Current shutoff**
- **200 kHz operation @ 400V, 19A**
- **100 kHz operation @ 400V, 26A**
- **SSOA rated**

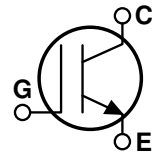
MAXIMUM RATINGS

 All Ratings: $T_C = 25^\circ\text{C}$ unless otherwise specified.

Symbol	Parameter	APT50GP60J	UNIT
V_{CES}	Collector-Emitter Voltage	600	Volts
V_{GE}	Gate-Emitter Voltage	± 20	
V_{GEM}	Gate-Emitter Voltage Transient	± 30	
I_{C1}	Continuous Collector Current @ $T_C = 25^\circ\text{C}$	100	Amps
I_{C2}	Continuous Collector Current @ $T_C = 110^\circ\text{C}$	46	
I_{CM}	Pulsed Collector Current ^① @ $T_C = 25^\circ\text{C}$	190	
SSOA	Safe Operating Area @ $T_J = 150^\circ\text{C}$	190A@600V	
P_D	Total Power Dissipation	329	Watts
T_J, T_{STG}	Operating and Storage Junction Temperature Range	-55 to 150	$^\circ\text{C}$
T_L	Max. Lead Temp. for Soldering: 0.063" from Case for 10 Sec.	300	

STATIC ELECTRICAL CHARACTERISTICS

Symbol	Characteristic / Test Conditions	MIN	TYP	MAX	UNIT
BV_{CES}	Collector-Emitter Breakdown Voltage ($V_{GE} = 0V, I_C = 500\mu\text{A}$)	600			Volts
$V_{GE(TH)}$	Gate Threshold Voltage ($V_{CE} = V_{GE}, I_C = 1\text{mA}, T_J = 25^\circ\text{C}$)	3	4.5	6	
$V_{CE(ON)}$	Collector-Emitter On Voltage ($V_{GE} = 15V, I_C = 50A, T_J = 25^\circ\text{C}$)		2.2	2.7	
	Collector-Emitter On Voltage ($V_{GE} = 15V, I_C = 50A, T_J = 125^\circ\text{C}$)		2.1		
I_{CES}	Collector Cut-off Current ($V_{CE} = 600V, V_{GE} = 0V, T_J = 25^\circ\text{C}$) ^②			500	μA
	Collector Cut-off Current ($V_{CE} = 600V, V_{GE} = 0V, T_J = 125^\circ\text{C}$) ^②			2500	
I_{GES}	Gate-Emitter Leakage Current ($V_{GE} = \pm 20V$)			± 100	nA

 **CAUTION:** These Devices are Sensitive to Electrostatic Discharge. Proper Handling Procedures Should Be Followed.

DYNAMIC CHARACTERISTICS

APT50GP60J

Symbol	Characteristic	Test Conditions	MIN	TYP	MAX	UNIT	
C_{ies}	Input Capacitance	Capacitance $V_{GE} = 0V, V_{CE} = 25V$ $f = 1 \text{ MHz}$		5700		pF	
C_{oes}	Output Capacitance			465			
C_{res}	Reverse Transfer Capacitance			30			
V_{GEP}	Gate-to-Emitter Plateau Voltage	Gate Charge $V_{GE} = 15V$ $V_{CE} = 300V$ $I_C = 50A$		7.5		V	
Q_g	Total Gate Charge ^③			165		nC	
Q_{ge}	Gate-Emitter Charge			40			
Q_{gc}	Gate-Collector ("Miller") Charge			50			
SSOA	Safe Operating Area	$T_J = 150^\circ\text{C}, R_G = 5\Omega, V_{GE} = 15V, L = 100\mu\text{H}, V_{CE} = 600V$	190			A	
$t_{d(on)}$	Turn-on Delay Time	Inductive Switching (25°C) $V_{CC} = 400V$ $V_{GE} = 15V$ $I_C = 50A$ $R_G = 5\Omega$ $T_J = +25^\circ\text{C}$		19		ns	
t_r	Current Rise Time			36			
$t_{d(off)}$	Turn-off Delay Time			83			
t_f	Current Fall Time			60			
E_{on1}	Turn-on Switching Energy ^④				465		μJ
E_{on2}	Turn-on Switching Energy (Diode) ^⑤				837		
E_{off}	Turn-off Switching Energy ^⑥				637		
$t_{d(on)}$	Turn-on Delay Time		Inductive Switching (125°C) $V_{CC} = 400V$ $V_{GE} = 15V$ $I_C = 50A$ $R_G = 5\Omega$ $T_J = +125^\circ\text{C}$		19		ns
t_r	Current Rise Time			36			
$t_{d(off)}$	Turn-off Delay Time			116			
t_f	Current Fall Time			86			
E_{on1}	Turn-on Switching Energy ^④				465		μJ
E_{on2}	Turn-on Switching Energy (Diode) ^⑤				1261		
E_{off}	Turn-off Switching Energy ^⑥				1058		

THERMAL AND MECHANICAL CHARACTERISTICS

Symbol	Characteristic	MIN	TYP	MAX	UNIT
$R_{\theta JC}$	Junction to Case (IGBT)			.38	$^\circ\text{C/W}$
$R_{\theta JC}$	Junction to Case (DIODE)			N/A	
W_T	Package Weight			29.2	gm

- ① Repetitive Rating: Pulse width limited by maximum junction temperature.
- ② For Combi devices, I_{ces} includes both IGBT and FRED leakages
- ③ See MIL-STD-750 Method 3471.
- ④ E_{on1} is the clamped inductive turn-on-energy of the IGBT only, without the effect of a commutating diode reverse recovery current adding to the IGBT turn-on loss. (See Figure 24.)
- ⑤ E_{on2} is the clamped inductive turn-on energy that includes a commutating diode reverse recovery current in the IGBT turn-on switching loss. A Combi device is used for the clamping diode as shown in the E_{on2} test circuit. (See Figures 21, 22.)
- ⑥ E_{off} is the clamped inductive turn-off energy measured in accordance with JEDEC standard JESD24-1. (See Figures 21, 23.)
- APT Reserves the right to change, without notice, the specifications and information contained herein.**

TYPICAL PERFORMANCE CURVES

APT50GP60J

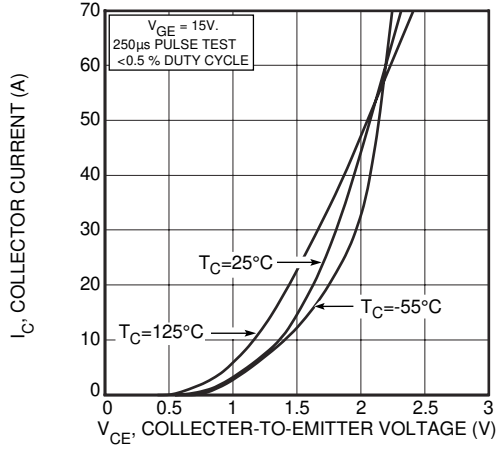

FIGURE 1, Output Characteristics ($V_{GE} = 15V$)

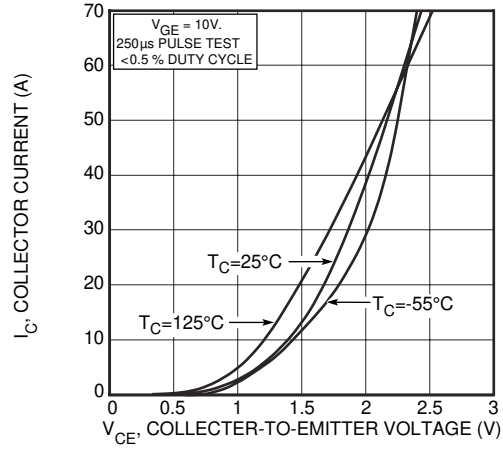

FIGURE 2, Output Characteristics ($V_{GE} = 10V$)

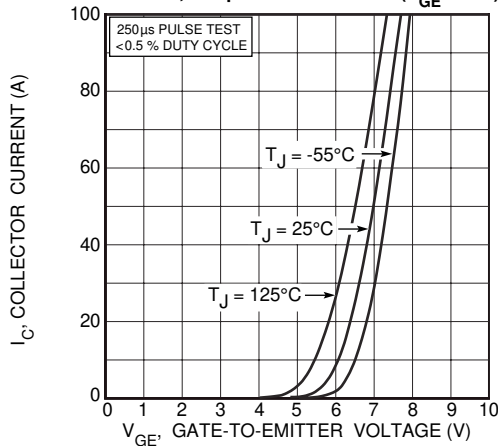

FIGURE 3, Transfer Characteristics

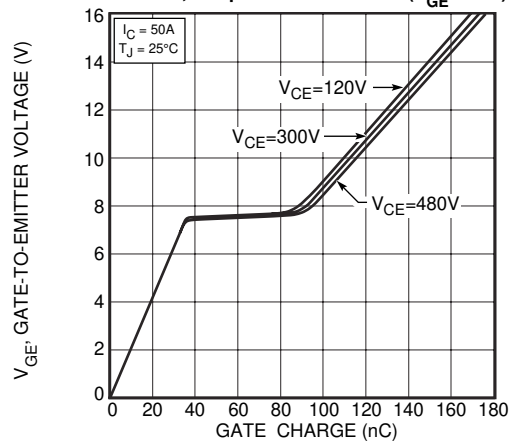

FIGURE 4, Gate Charge

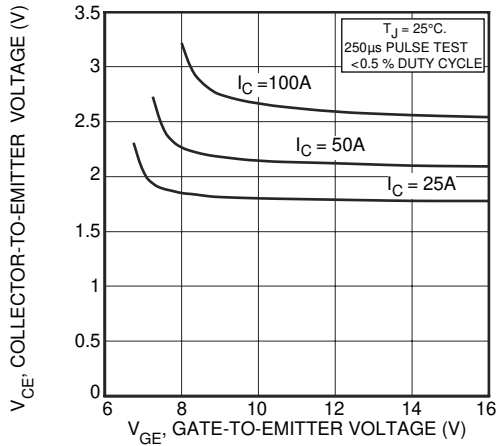

FIGURE 5, On State Voltage vs Gate-to-Emitter Voltage

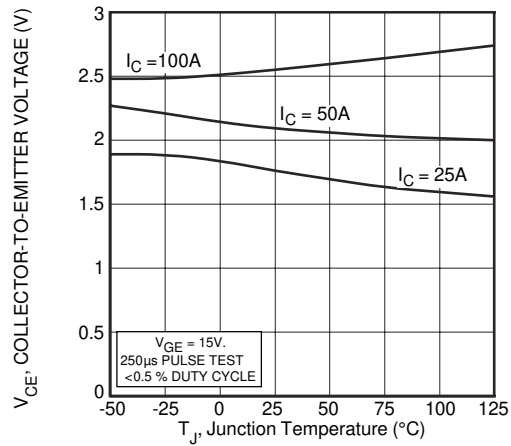

FIGURE 6, On State Voltage vs Junction Temperature

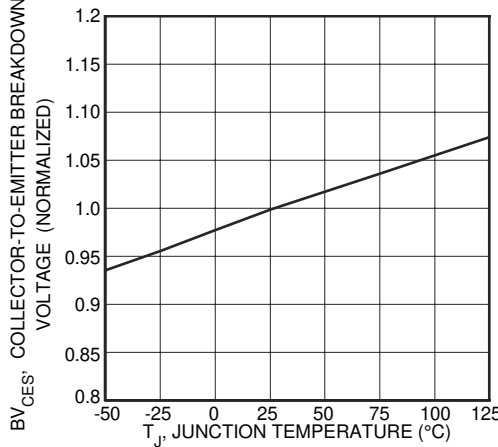

FIGURE 7, Breakdown Voltage vs. Junction Temperature

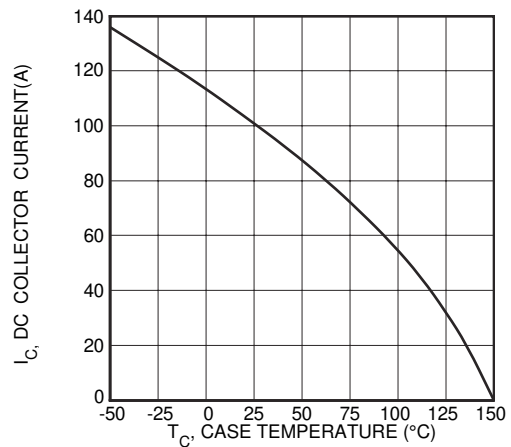

FIGURE 8, DC Collector Current vs Case Temperature

TYPICAL PERFORMANCE CURVES

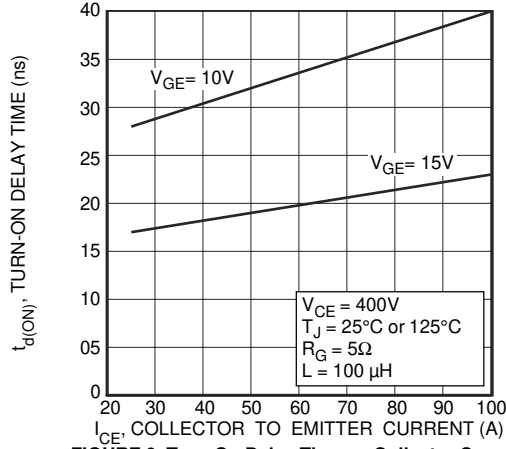

FIGURE 9, Turn-On Delay Time vs Collector Current

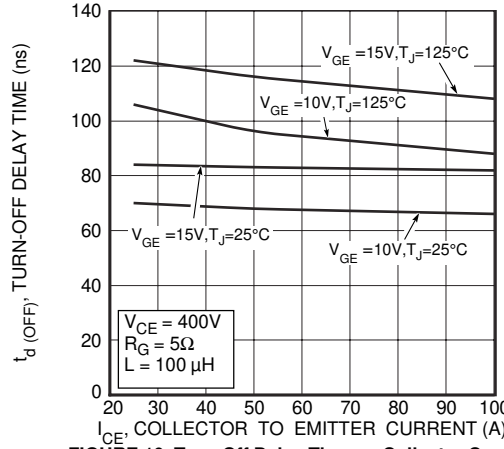

FIGURE 10, Turn-Off Delay Time vs Collector Current

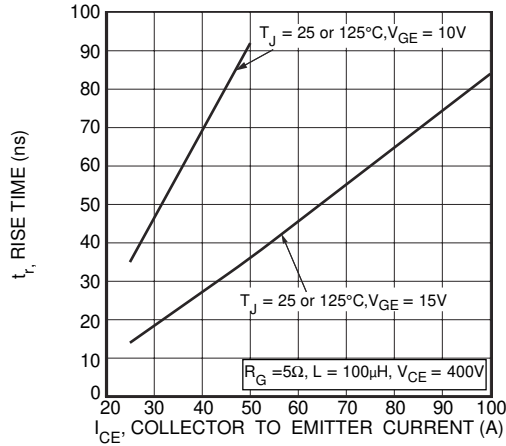

FIGURE 11, Current Rise Time vs Collector Current

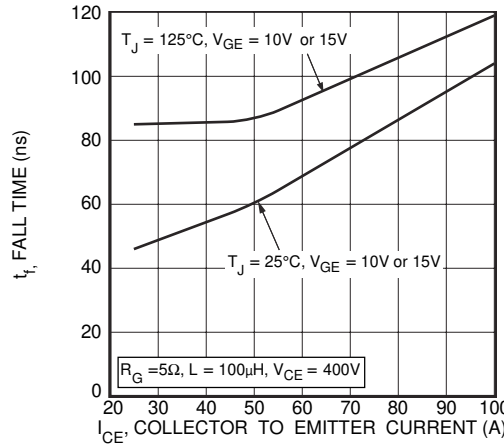

FIGURE 12, Current Fall Time vs Collector Current

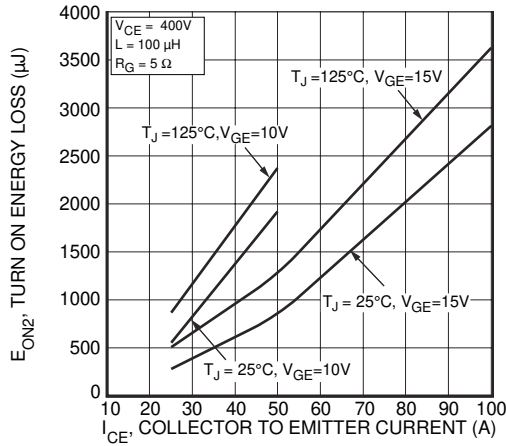

FIGURE 13, Turn-On Energy Loss vs Collector Current

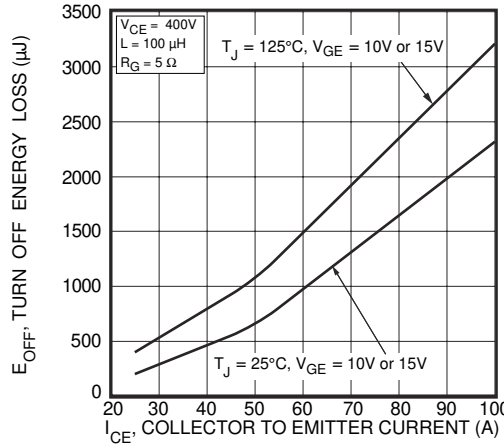

FIGURE 14, Turn Off Energy Loss vs Collector Current

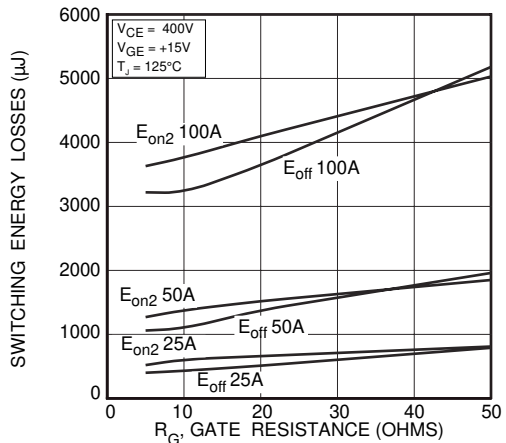

FIGURE 15, Switching Energy Losses vs. Gate Resistance

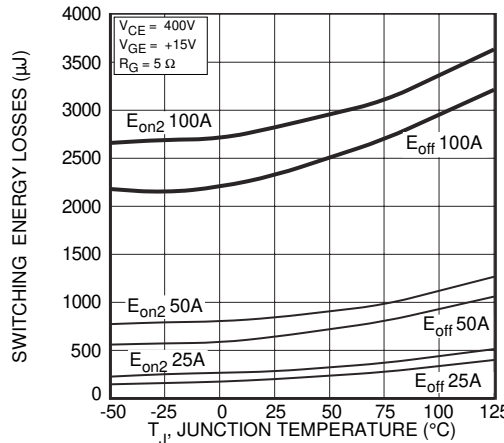

FIGURE 16, Switching Energy Losses vs Junction Temperature

TYPICAL PERFORMANCE CURVES

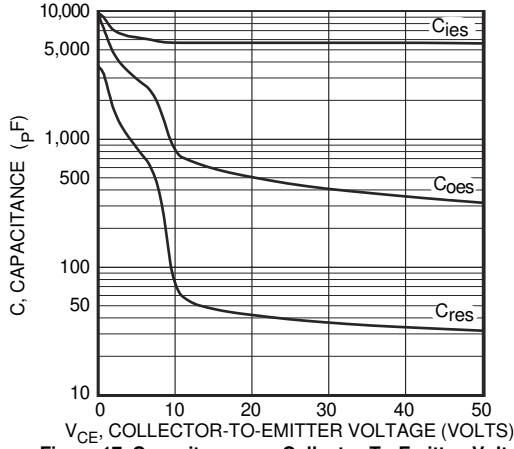

Figure 17, Capacitance vs Collector-To-Emitter Voltage

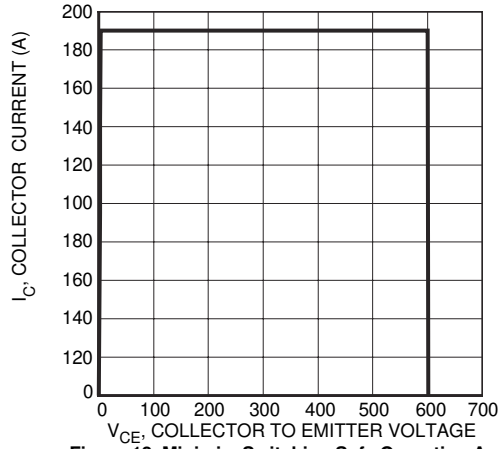

Figure 18, Minimum Switching Safe Operating Area

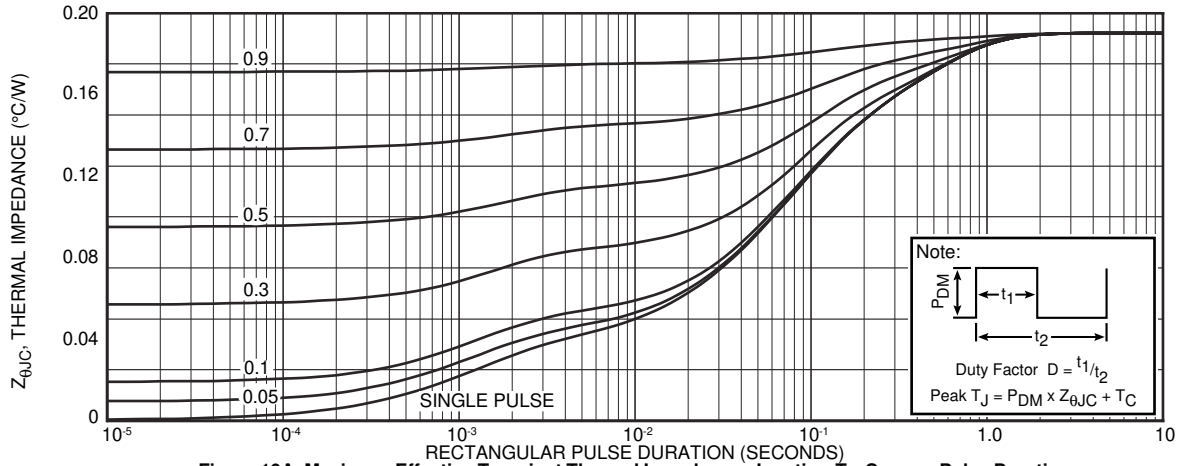

Figure 19A, Maximum Effective Transient Thermal Impedance, Junction-To-Case vs Pulse Duration

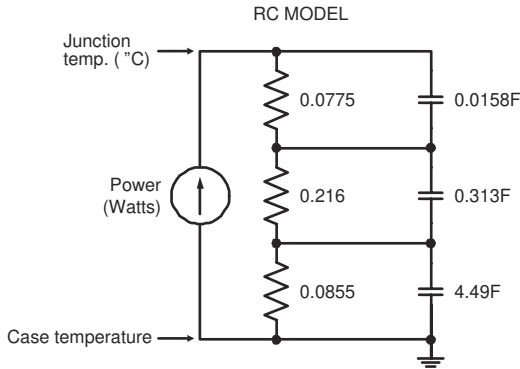

FIGURE 19B, TRANSIENT THERMAL IMPEDANCE MODEL

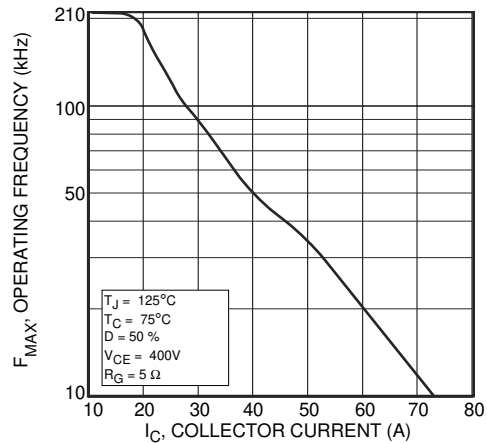

Figure 20, Operating Frequency vs Collector Current

$$F_{max} = \min(f_{max1}, f_{max2})$$

$$f_{max1} = \frac{0.05}{t_{d(on)} + t_r + t_{d(off)} + t_f}$$

$$f_{max2} = \frac{P_{diss} - P_{cond}}{E_{on2} + E_{off}}$$

$$P_{diss} = \frac{T_J - T_C}{R_{\theta JC}}$$

TYPICAL PERFORMANCE CURVES

APT50GP60J

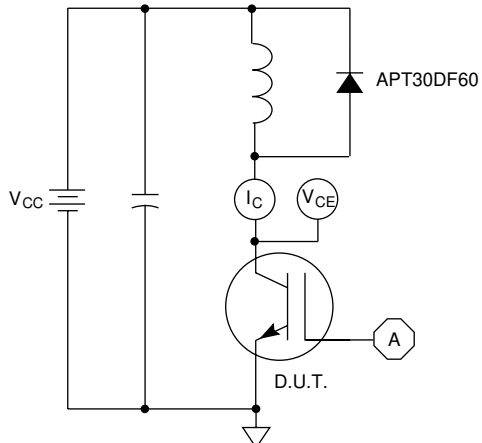

Figure 21, Inductive Switching Test Circuit

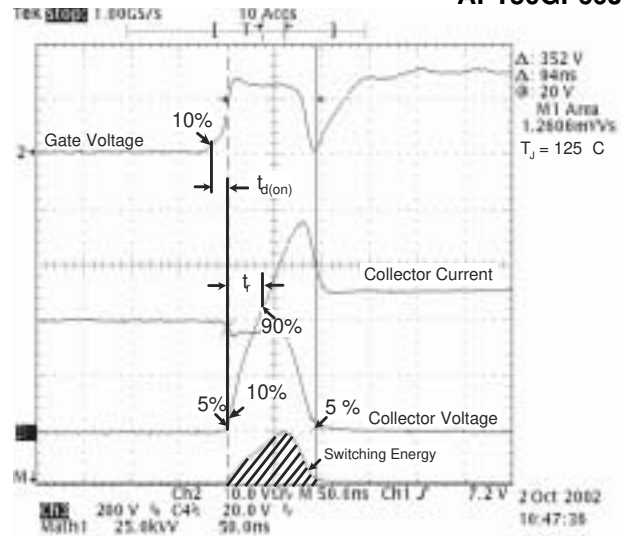

Figure 22, Turn-on Switching Waveforms and Definitions

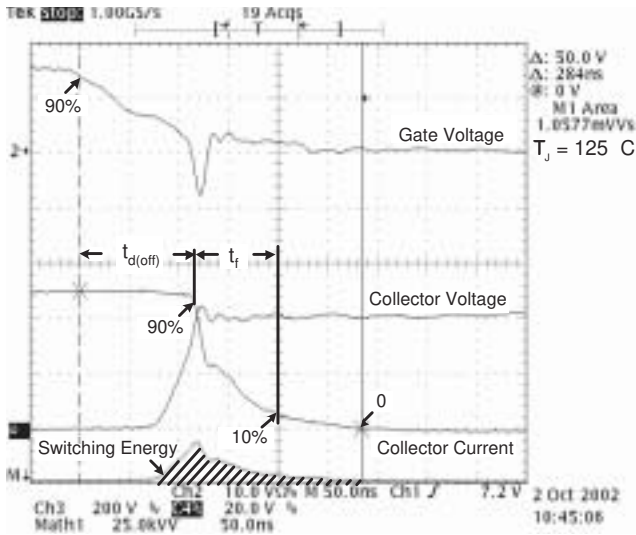

Figure 23, Turn-off Switching Waveforms and Definitions

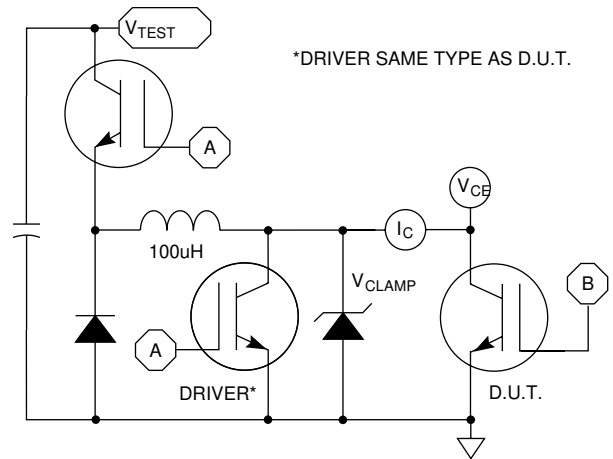
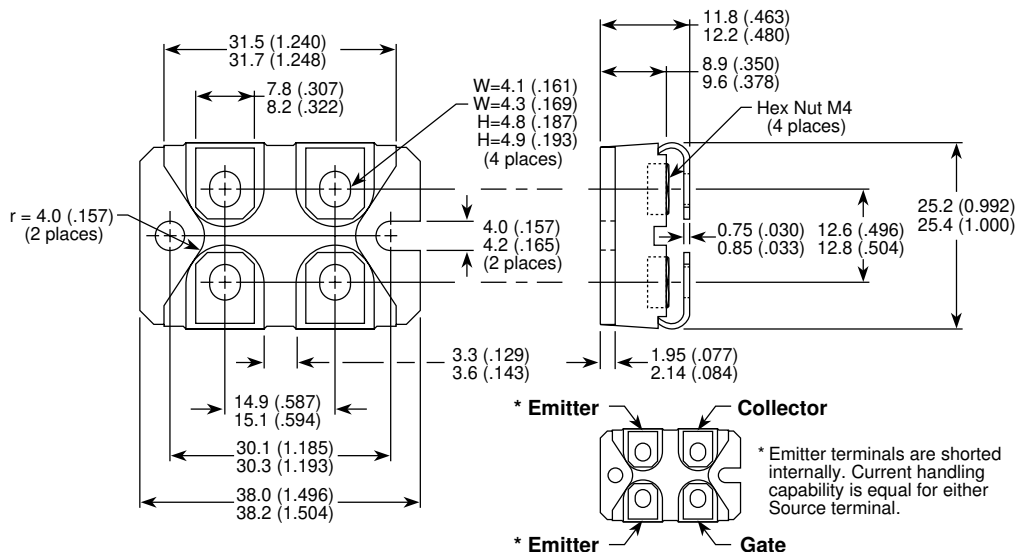

Figure 24, E_{ON1} Test Circuit

SOT-227 (ISOTOP®) Package Outline



Dimensions in Millimeters and (Inches)

APT's products are covered by one or more of U.S. patents 4,895,810 5,045,903 5,089,434 5,182,234 5,019,522 5,262,336 6,503,786 5,256,583 4,748,103 5,283,202 5,231,474 5,434,095 5,528,058 and foreign patents. US and Foreign patents pending. All Rights Reserved.