



Chipsmall Limited consists of a professional team with an average of over 10 year of expertise in the distribution of electronic components. Based in Hongkong, we have already established firm and mutual-benefit business relationships with customers from,Europe,America and south Asia,supplying obsolete and hard-to-find components to meet their specific needs.

With the principle of “Quality Parts,Customers Priority,Honest Operation,and Considerate Service”,our business mainly focus on the distribution of electronic components. Line cards we deal with include Microchip,ALPS,ROHM,Xilinx,Pulse,ON,Everlight and Freescale. Main products comprise IC,Modules,Potentiometer,IC Socket,Relay,Connector.Our parts cover such applications as commercial,industrial, and automotives areas.

We are looking forward to setting up business relationship with you and hope to provide you with the best service and solution. Let us make a better world for our industry!



Contact us

Tel: +86-755-8981 8866 Fax: +86-755-8427 6832

Email & Skype: info@chipsmall.com Web: www.chipsmall.com

Address: A1208, Overseas Decoration Building, #122 Zhenhua RD., Futian, Shenzhen, China



Resonant Mode Combi IGBT®

The POWER MOS 7th IGBT used in this resonant mode combi is a new generation of high voltage power IGBTs. Using Punch Through Technology this IGBT is ideal for many high frequency, high voltage switching applications and has been optimized for high frequency switchmode power supplies.

Features

- Low Conduction Loss
- Low Gate Charge
- Ultrafast Tail Current shutoff
- Low forward Diode Voltage (V_F)
- Ultrasoft Recovery Diode

- SSOA Rated
- RoHS Compliant 

Typical Applications

- Induction Heating
- Welding
- Medical
- High Power Telecom
- Resonant Mode Phase Shifted Bridge

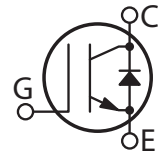
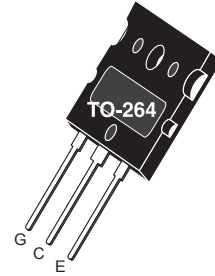

MAXIMUM RATINGS

All Ratings: $T_C = 25^\circ C$ unless otherwise specified.

| Symbol | Parameter | Ratings | UNIT |
|----------------|--|-------------|------------|
| V_{CES} | Collector-Emitter Voltage | 600 | Volts |
| V_{GE} | Gate-Emitter Voltage | ± 30 | |
| I_{C1} | Continuous Collector Current ⁷ @ $T_C = 25^\circ C$ | 150 | Amps |
| I_{C2} | Continuous Collector Current @ $T_C = 110^\circ C$ | 72 | |
| I_{CM} | Pulsed Collector Current ¹ | 190 | |
| SSOA | Switching Safe Operating Area @ $T_j = 150^\circ C$ | 190A @ 600V | |
| P_D | Total Power Dissipation | 625 | Watts |
| T_j, T_{STG} | Operating and Storage Junction Temperature Range | -55 to 150 | $^\circ C$ |
| T_L | Max. Lead Temp. for Soldering: 0.063" from Case for 10 Sec. | 300 | |

STATIC ELECTRICAL CHARACTERISTICS

| Symbol | Characteristic / Test Conditions | MIN | TYP | MAX | Units |
|---------------|--|-----|-----|-----------|---------|
| $V_{(BR)CES}$ | Collector-Emitter Breakdown Voltage ($V_{GE} = 0V, I_C = 1.0mA$) | 600 | | | Volts |
| $V_{GE(TH)}$ | Gate Threshold Voltage ($V_{CE} = V_{GE}, I_C = 1mA, T_j = 25^\circ C$) | 3 | 4.5 | 6 | |
| $V_{CE(ON)}$ | Collector-Emitter On Voltage ($V_{GE} = 15V, I_C = 50A, T_j = 25^\circ C$) | | 2.2 | 2.7 | |
| | Collector-Emitter On Voltage ($V_{GE} = 15V, I_C = 50A, T_j = 125^\circ C$) | | 2.1 | | |
| I_{CES} | Collector Cut-off Current ($V_{CE} = 600V, V_{GE} = 0V, T_j = 25^\circ C$) ² | | | 525 | μA |
| | Collector Cut-off Current ($V_{CE} = 600V, V_{GE} = 0V, T_j = 125^\circ C$) ² | | | 2750 | |
| I_{GES} | Gate-Emitter Leakage Current ($V_{GE} = \pm 20V$) | | | ± 100 | nA |

 CAUTION: These Devices are Sensitive to Electrostatic Discharge. Proper Handling Procedures Should Be Followed.

DYNAMIC CHARACTERISTICS

APT50GP60LDL(G)

| Symbol | Characteristic | Test Conditions | MIN | TYP | MAX | UNIT | |
|--------------|---|--|-----|------|------|------|---------------|
| C_{ies} | Input Capacitance | Capacitance $V_{GE} = 0V, V_{CE} = 25V$ $f = 1 \text{ MHz}$ | | 5700 | | pF | |
| C_{oes} | Output Capacitance | | | 465 | | | |
| C_{res} | Reverse Transfer Capacitance | | | 30 | | | |
| V_{GEP} | Gate-to-Emitter Plateau Voltage | Gate Charge $V_{GE} = 15V$ $V_{CE} = 300V$ $I_C = 50A$ | | 7.5 | | V | |
| Q_g | Total Gate Charge ³ | | | 165 | | nC | |
| Q_{ge} | Gate-Emitter Charge | | | 40 | | | |
| Q_{gc} | Gate-Collector ("Miller") Charge | | | 50 | | | |
| SSOA | Switching Safe Operating Area | $T_J = 150^\circ\text{C}, R_G = 4.3\Omega, V_{GE} = 15V, L = 100\mu\text{H}, V_{CE} = 600V$ | 190 | | | A | |
| $t_{d(on)}$ | Turn-on Delay Time | Inductive Switching (25°C) $V_{CC} = 400V$ $V_{GE} = 15V$ $I_C = 50A$ $R_G = 4.3\Omega$ $T_J = +25^\circ\text{C}$ | | 19 | | ns | |
| t_r | Current Rise Time | | | 36 | | | |
| $t_{d(off)}$ | Turn-off Delay Time | | | 85 | | | |
| t_f | Current Fall Time | | | 60 | | | |
| E_{on1} | Turn-on Switching Energy ⁴ | | | | 465 | | μJ |
| E_{on2} | Turn-on Switching Energy (Diode) ⁵ | | | | 835 | | |
| E_{off} | Turn-off Switching Energy ⁶ | | | | 635 | | |
| $t_{d(on)}$ | Turn-on Delay Time | Inductive Switching (125°C) $V_{CC} = 400V$ $V_{GE} = 15V$ $I_C = 50A$ $R_G = 4.3\Omega$ $T_J = +125^\circ\text{C}$ | | 19 | | ns | |
| t_r | Current Rise Time | | | 36 | | | |
| $t_{d(off)}$ | Turn-off Delay Time | | | 115 | | | |
| t_f | Current Fall Time | | | 85 | | | |
| E_{on1} | Turn-on Switching Energy ⁴ | | | | 465 | | μJ |
| E_{on2} | Turn-on Switching Energy (Diode) ⁵ | | | | 1260 | | |
| E_{off} | Turn-off Switching Energy ⁶ | | | | 1060 | | |

THERMAL AND MECHANICAL CHARACTERISTICS

| Symbol | Characteristic | MIN | TYP | MAX | UNIT |
|-----------------|--------------------------|-----|------|-----|--------------------|
| $R_{\theta JC}$ | Junction to Case (IGBT) | | | .20 | $^\circ\text{C/W}$ |
| $R_{\theta JC}$ | Junction to Case (DIODE) | | | .63 | |
| W_T | Package Weight | | 6.10 | | gm |

- ① Repetitive Rating: Pulse width limited by maximum junction temperature.
- ② For Combi devices, I_{ces} includes both IGBT and FRED leakages
- ③ See MIL-STD-750 Method 3471.
- ④ E_{on1} is the clamped inductive turn-on-energy of the IGBT only, without the effect of a commutating diode reverse recovery current adding to the IGBT turn-on loss. (See Figure 24.)
- ⑤ E_{on2} is the clamped inductive turn-on energy that includes a commutating diode reverse recovery current in the IGBT turn-on switching loss. (See Figures 21, 22.)
- ⑥ E_{off} is the clamped inductive turn-off energy measured in accordance with JEDEC standard JESD24-1. (See Figures 21, 23.)
- ⑦ Continuous current limited by package lead temperature.

APT Reserves the right to change, without notice, the specifications and information contained herein.

TYPICAL PERFORMANCE CURVES

APT50GP60LDL(G)

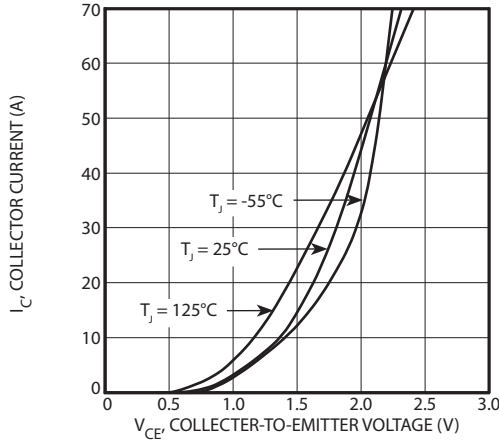

FIGURE 1, Output Characteristics ($V_{GE} = 15V$)

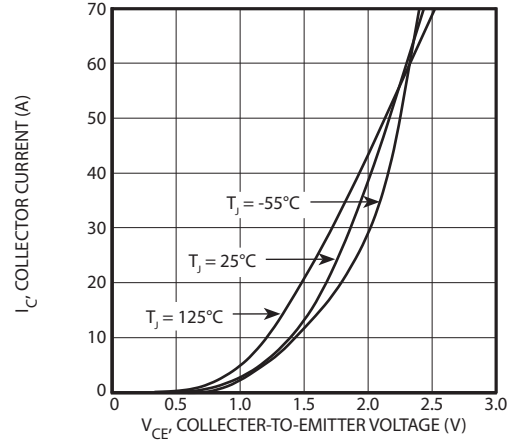

FIGURE 2, Output Characteristics ($V_{GE} = 10V$)

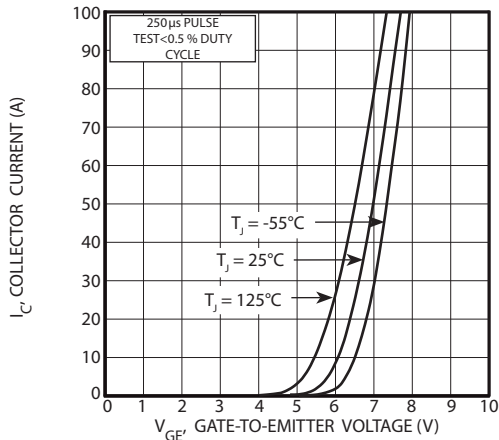

FIGURE 3, Transfer Characteristics

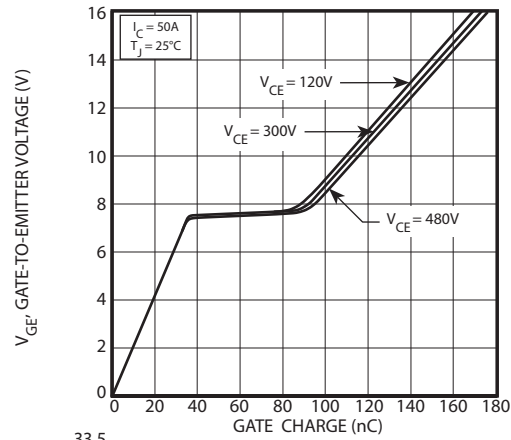

FIGURE 4, Gate Charge

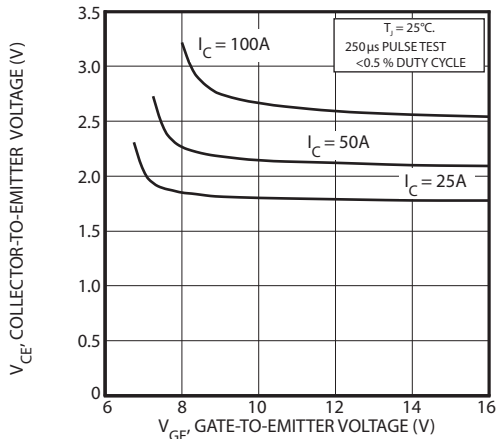

FIGURE 5, On State Voltage vs Gate-to-Emitter Voltage

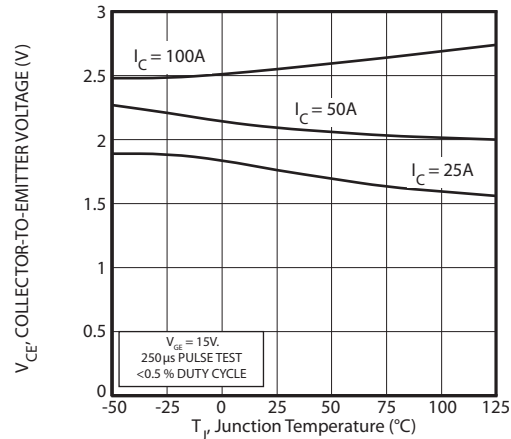

FIGURE 6, On State Voltage vs Junction Temperature

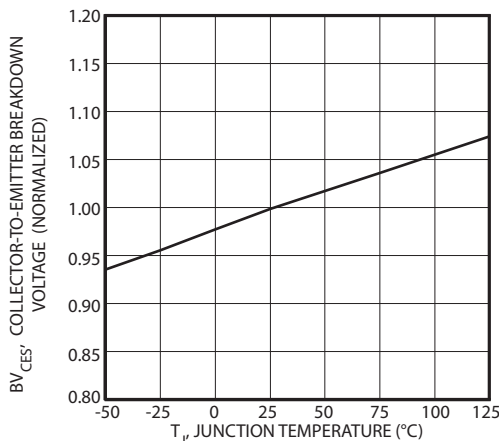

FIGURE 7, Breakdown Voltage vs. Junction Temperature

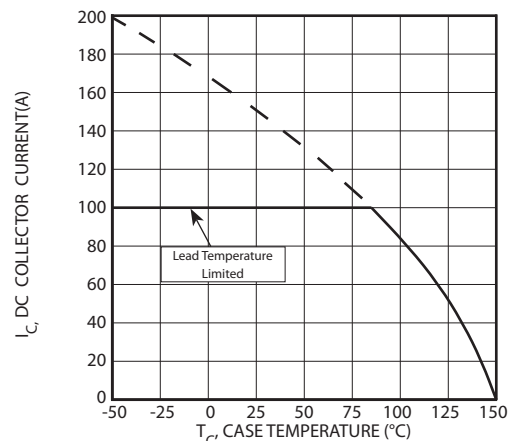

FIGURE 8, DC Collector Current vs Case Temperature

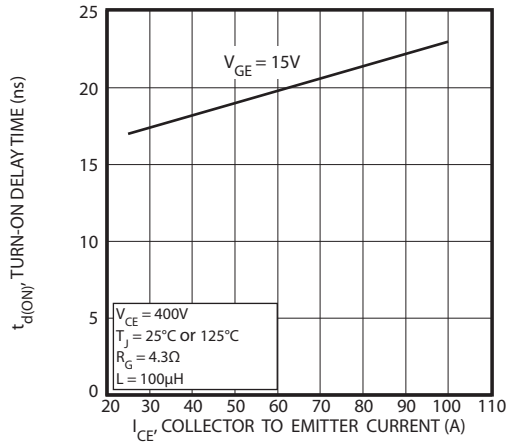

FIGURE 9, Turn-On Delay Time vs Collector Current

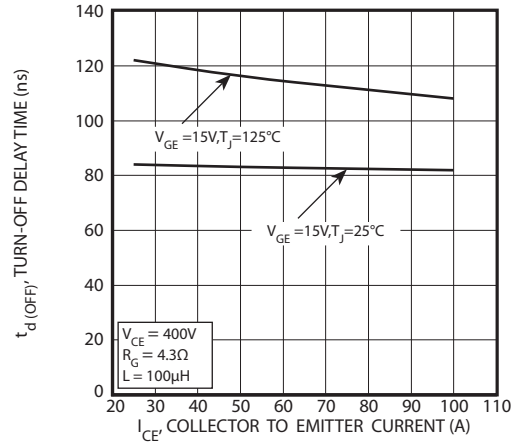

FIGURE 10, Turn-Off Delay Time vs Collector Current

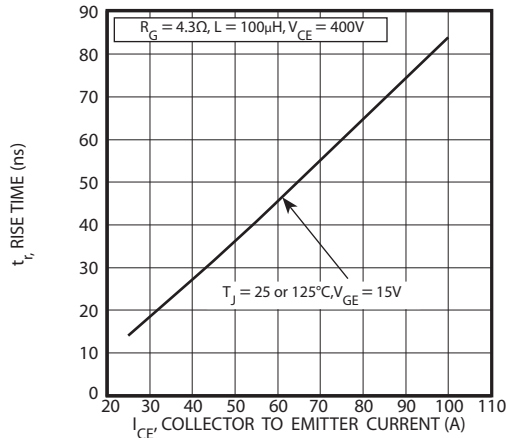

FIGURE 11, Current Rise Time vs Collector Current

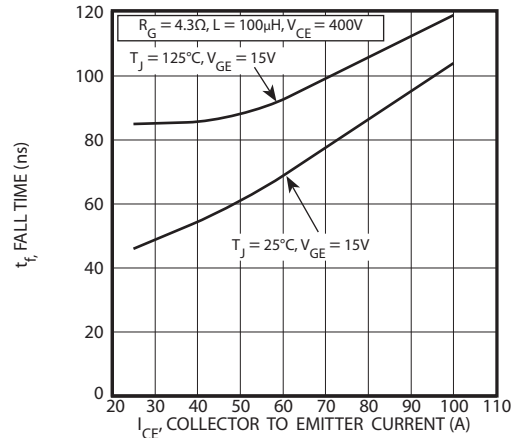

FIGURE 12, Current Fall Time vs Collector Current

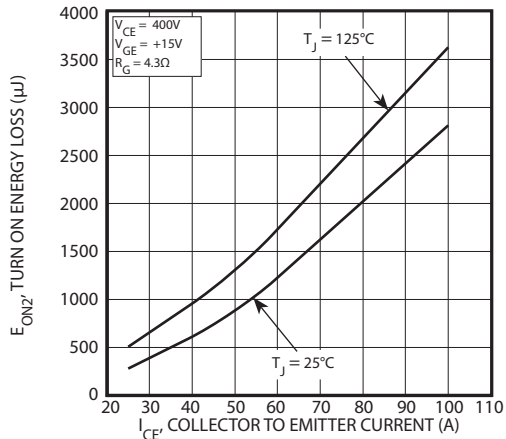

FIGURE 13, Turn-On Energy Loss vs Collector Current

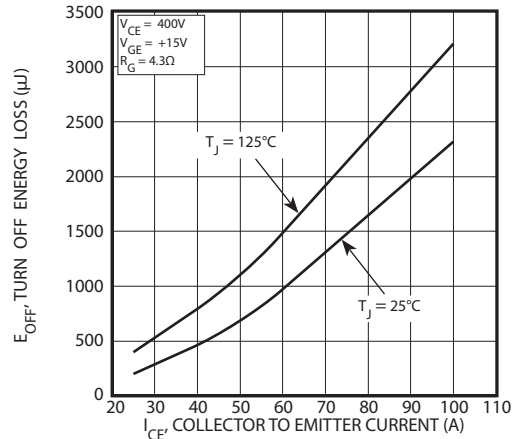

FIGURE 14, Turn Off Energy Loss vs Collector Current

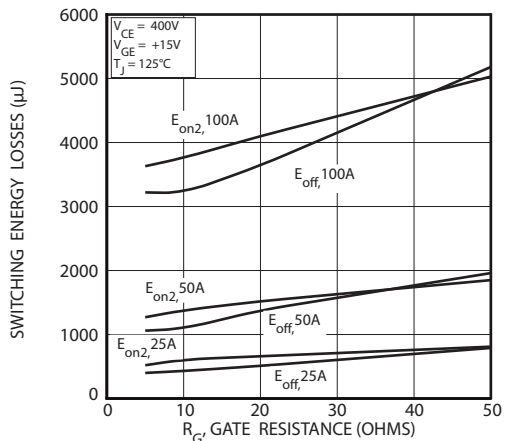

FIGURE 15, Switching Energy Losses vs. Gate Resistance

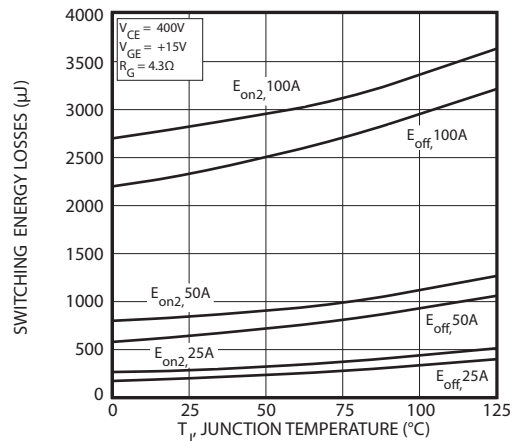

FIGURE 16, Switching Energy Losses vs Junction Temperature

TYPICAL PERFORMANCE CURVES

APT50GP60LDL(G)

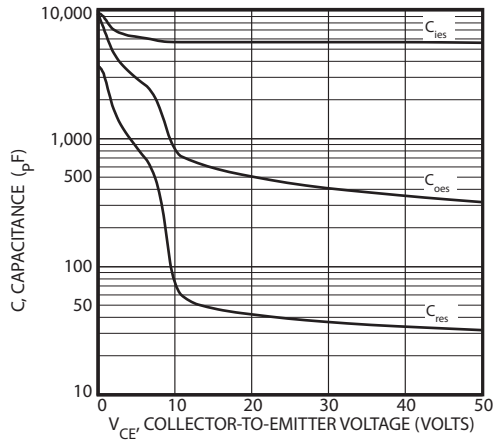

Figure 17, Capacitance vs Collector-To-Emitter Voltage

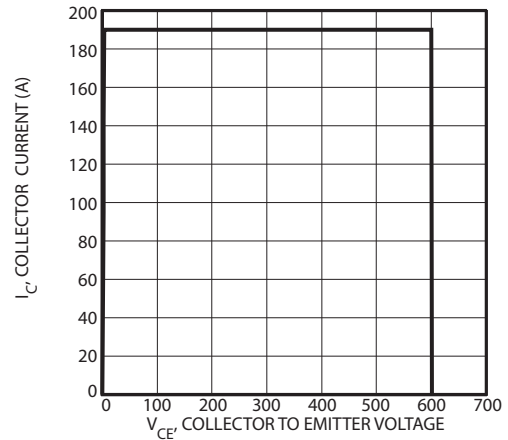

Figure 18, Minimum Switching Safe Operating Area

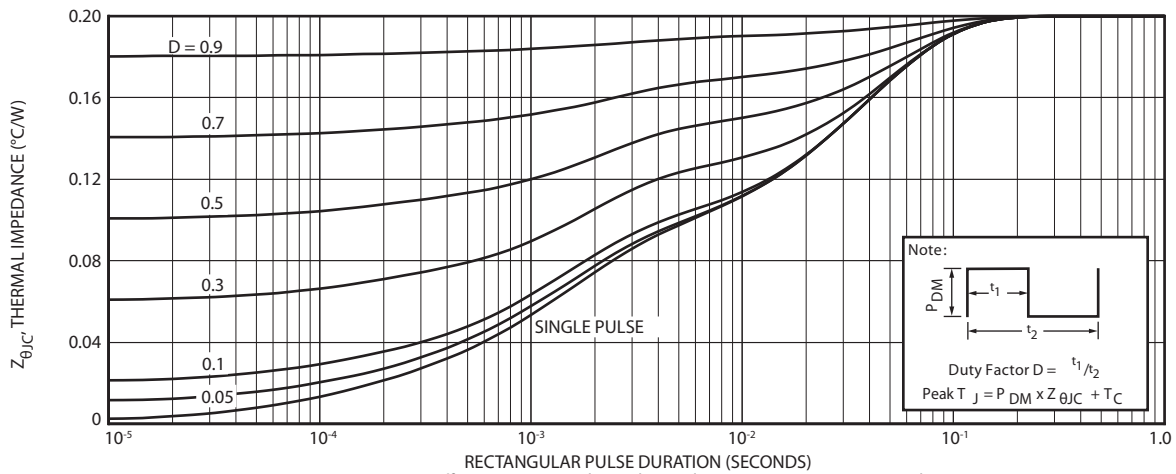

Figure 19a, Maximum Effective Transient Thermal Impedance, Junction-To-Case vs Pulse Duration

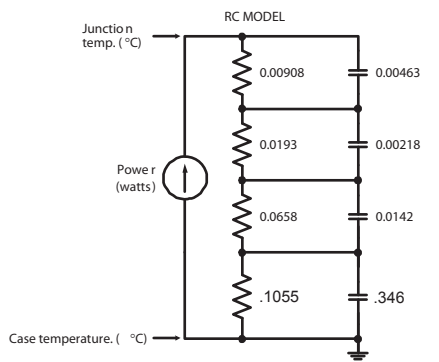

FIGURE 19b, TRANSIENT THERMAL IMPEDANCE MODEL

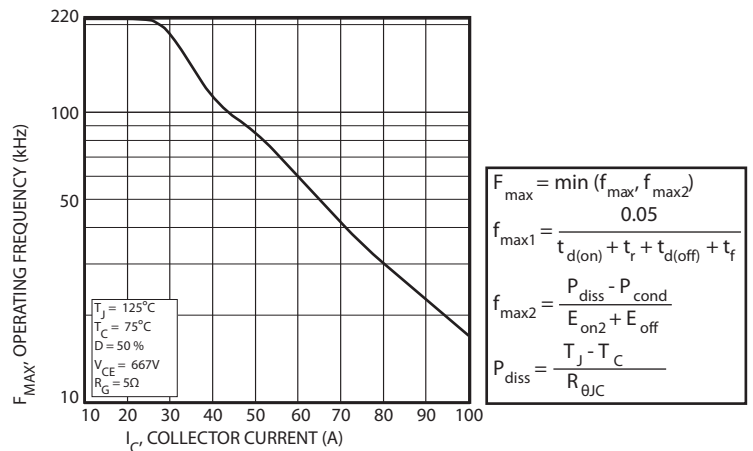

Figure 20, Operating Frequency vs Collector Current

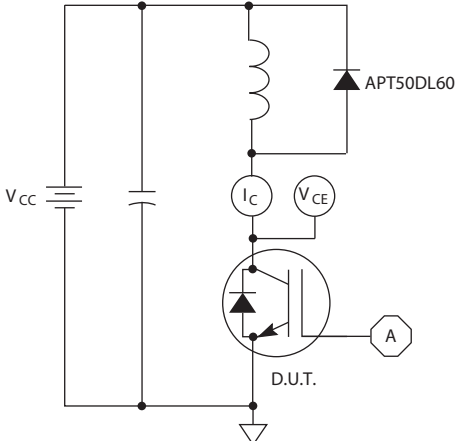

Figure 21, Inductive Switching Test Circuit

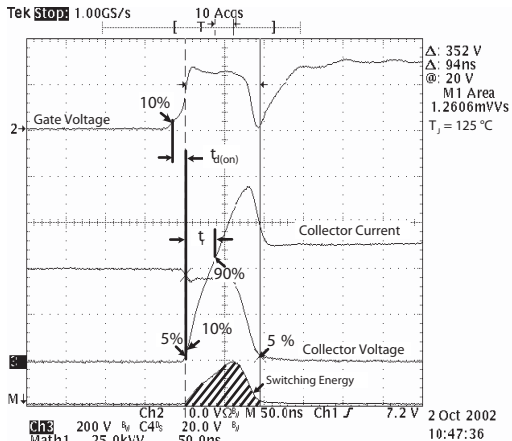

Figure 22, Turn-on Switching Waveforms and Definitions

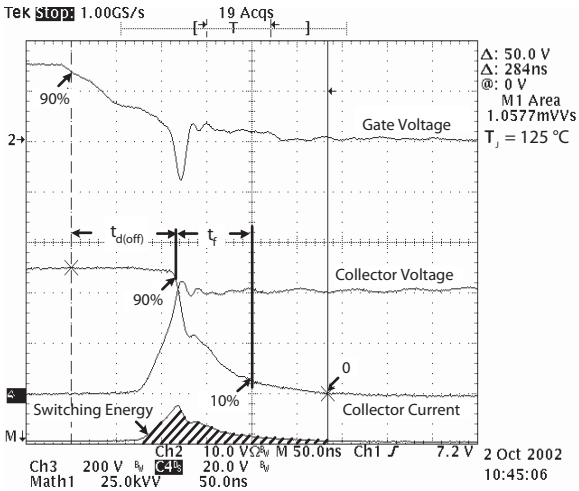

Figure 23, Turn-off Switching Waveforms and Definitions

ULTRAFAST SOFT RECOVERY ANTI-PARALLEL DIODE

MAXIMUM RATINGS

All Ratings: $T_C = 25^\circ\text{C}$ unless otherwise specified.

| Symbol | Characteristic / Test Conditions | APT50GP60LDL(G) | | UNIT |
|------------|---|-----------------|--|------|
| $I_F(AV)$ | Maximum Average Forward Current ($T_C = 124^\circ\text{C}$, Duty Cycle = 0.5) | 50 | | Amps |
| $I_F(RMS)$ | RMS Forward Current (Square wave, 50% duty) | 150 | | |
| I_{FSM} | Non-Repetitive Forward Surge Current ($T_J = 45^\circ\text{C}$, 8.3ms) | 320 | | |

STATIC ELECTRICAL CHARACTERISTICS

| Symbol | Characteristic / Test Conditions | MIN | TYP | MAX | UNIT |
|--------|----------------------------------|---|------|-----|-------|
| V_F | Forward Voltage | $I_F = 50\text{A}$ | 1.25 | 1.6 | Volts |
| | | $I_F = 100\text{A}$ | 2.0 | | |
| | | $I_F = 50\text{A}, T_J = 125^\circ\text{C}$ | 1.25 | | |

DYNAMIC CHARACTERISTICS

| Symbol | Characteristic | Test Conditions | MIN | TYP | MAX | UNIT |
|-----------|----------------------------------|---|-----|------|-----|------|
| t_{rr} | Reverse Recovery Time | $I_F = 1\text{A}, di_F/dt = -100\text{A}/\mu\text{s}, V_R = 30\text{V}, T_J = 25^\circ\text{C}$ | - | 52 | | ns |
| t_{rr} | Reverse Recovery Time | $I_F = 50\text{A}, di_F/dt = -200\text{A}/\mu\text{s}, V_R = 400\text{V}, T_C = 25^\circ\text{C}$ | - | 399 | | |
| Q_{rr} | Reverse Recovery Charge | | - | 1498 | | nC |
| I_{RRM} | Maximum Reverse Recovery Current | | - | 9 | - | Amps |
| t_{rr} | Reverse Recovery Time | $I_F = 50\text{A}, di_F/dt = -200\text{A}/\mu\text{s}, V_R = 400\text{V}, T_C = 125^\circ\text{C}$ | - | 649 | | ns |
| Q_{rr} | Reverse Recovery Charge | | - | 3734 | | nC |
| I_{RRM} | Maximum Reverse Recovery Current | | - | 13 | - | Amps |
| t_{rr} | Reverse Recovery Time | $I_F = 50\text{A}, di_F/dt = -1000\text{A}/\mu\text{s}, V_R = 400\text{V}, T_C = 125^\circ\text{C}$ | - | 284 | | ns |
| Q_{rr} | Reverse Recovery Charge | | - | 5134 | | nC |
| I_{RRM} | Maximum Reverse Recovery Current | | - | 34 | | Amps |

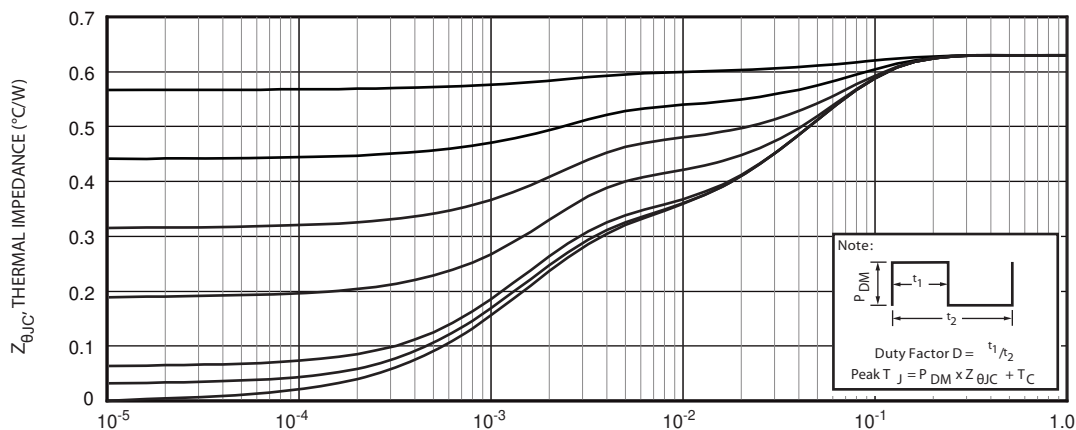

FIGURE 1a. MAXIMUM EFFECTIVE TRANSIENT THERMAL IMPEDANCE, JUNCTION-TO-CASE vs. PULSE DURATION

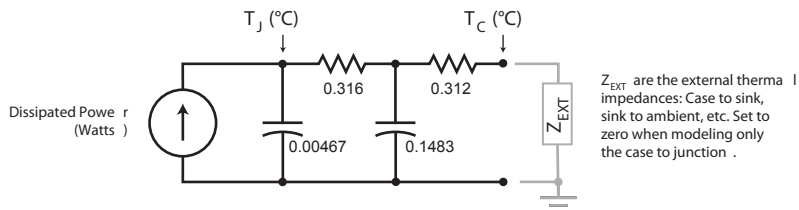

FIGURE 1b, TRANSIENT THERMAL IMPEDANCE MODEL

TYPICAL PERFORMANCE CURVES

APT50GP60LDL(G)

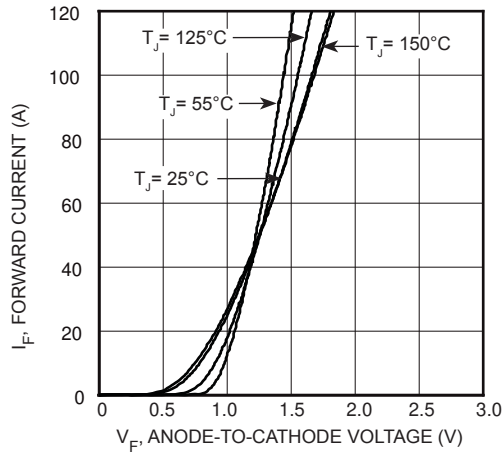

FIGURE 2, Forward Current vs. Forward Voltage

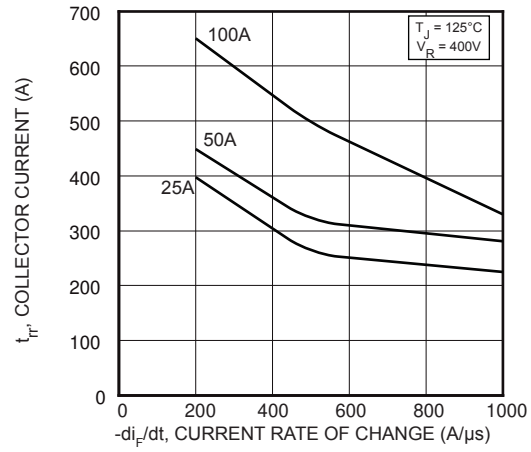

FIGURE 3, Reverse Recovery Time vs. Current Rate of Change

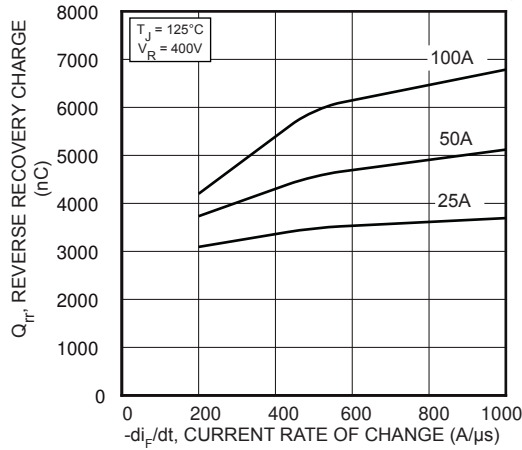

FIGURE 4, Reverse Recovery Charge vs. Current Rate of Change

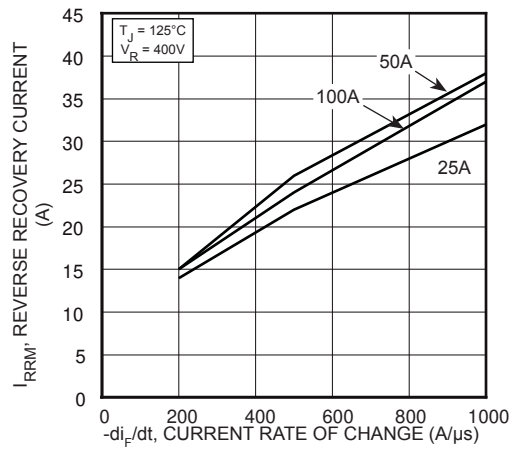

FIGURE 5, Reverse Recovery Current vs. Current Rate of Change

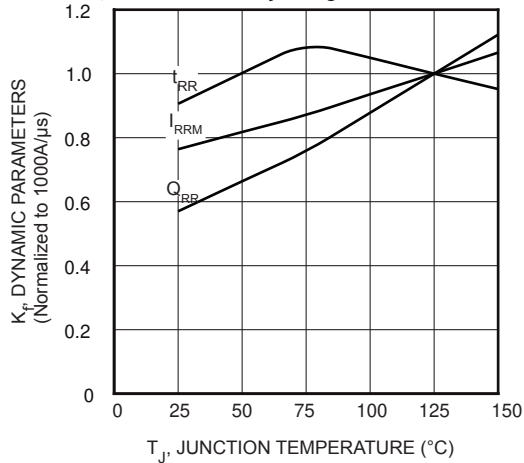

FIGURE 6, Dynamic Parameters vs. Junction Temperature

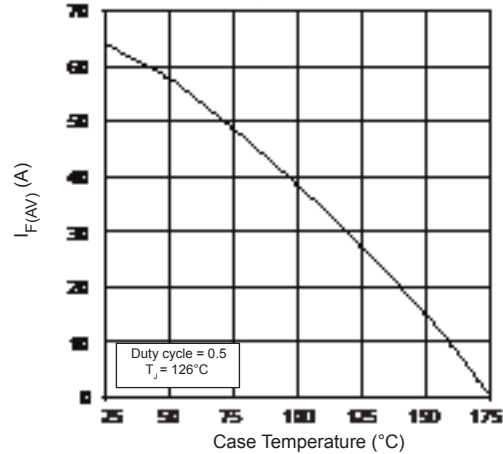

FIGURE 7, Maximum Average Forward Current vs. Case Temperature

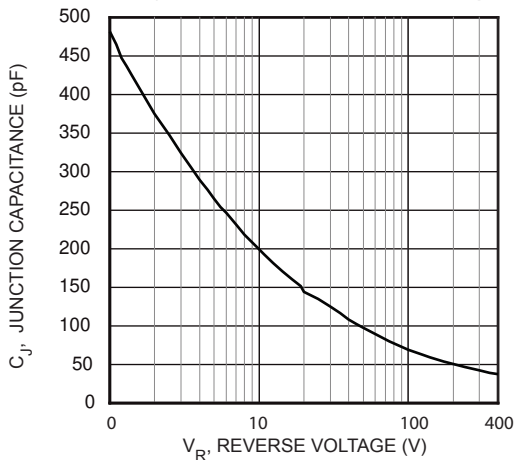

FIGURE 8, Junction Capacitance vs. Reverse Voltage

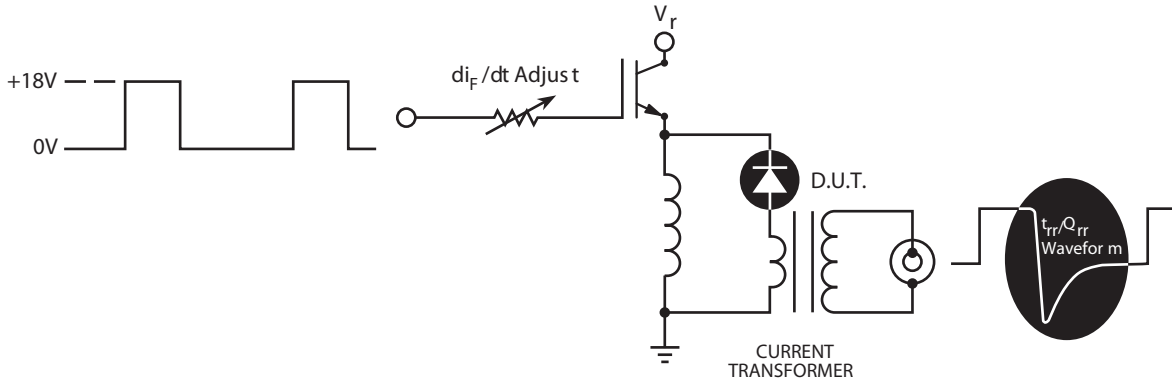

Figure 9. Diode Test Circuit

- 1 I_F - Forward Conduction Current
- 2 di_F/dt - Rate of Diode Current Change Through Zero Crossing.
- 3 I_{RRM} - Maximum Reverse Recovery Current
- 4 t_{rr} - Reverse Recovery Time, measured from zero crossing where the diode current goes from positive to negative, to the point at which the straight line through I_{RRM} and $0.25 I_{RRM}$ passes through zero.
- 5 Q_{rr} - Area Under the Curve Defined by I_{RRM} and t_{rr} .
- 6 di_M/dt - Maximum Rate of Current Increase During the Trailing Portion of t_{rr} .

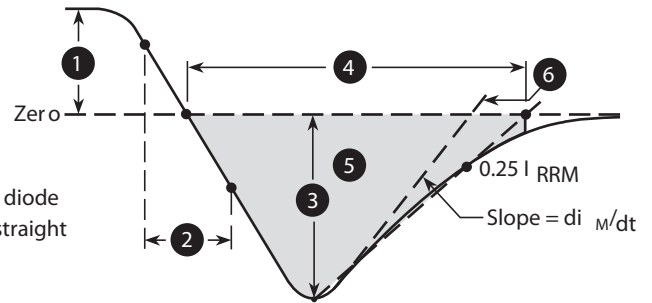
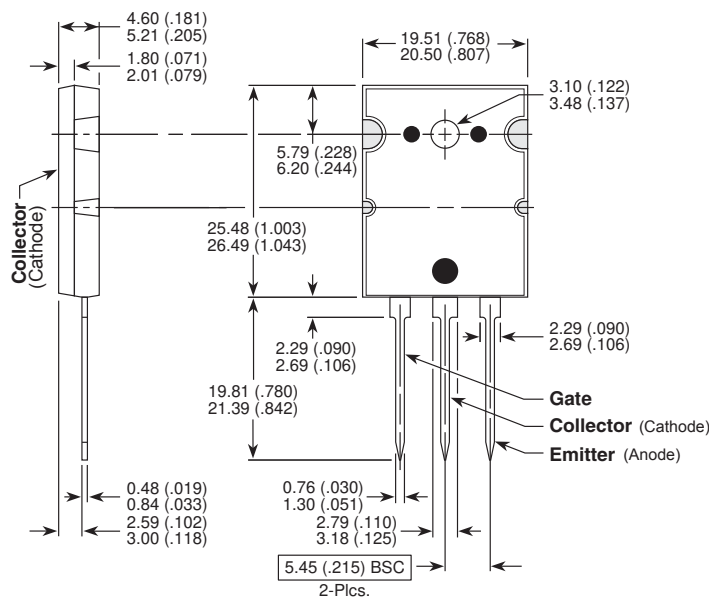

Figure 10, Diode Reverse Recovery Waveform and Definition

TO-264 (L) Package Outline



Dimensions in Millimeters and (Inches)