



Chipsmall Limited consists of a professional team with an average of over 10 year of expertise in the distribution of electronic components. Based in Hongkong, we have already established firm and mutual-benefit business relationships with customers from,Europe,America and south Asia,supplying obsolete and hard-to-find components to meet their specific needs.

With the principle of “Quality Parts,Customers Priority,Honest Operation,and Considerate Service”,our business mainly focus on the distribution of electronic components. Line cards we deal with include Microchip,ALPS,ROHM,Xilinx,Pulse,ON,Everlight and Freescale. Main products comprise IC,Modules,Potentiometer,IC Socket,Relay,Connector.Our parts cover such applications as commercial,industrial, and automotives areas.

We are looking forward to setting up business relationship with you and hope to provide you with the best service and solution. Let us make a better world for our industry!



Contact us

Tel: +86-755-8981 8866 Fax: +86-755-8427 6832

Email & Skype: info@chipsmall.com Web: www.chipsmall.com

Address: A1208, Overseas Decoration Building, #122 Zhenhua RD., Futian, Shenzhen, China



ULTRAFAST SOFT RECOVERY RECTIFIER DIODE

PRODUCT APPLICATIONS

- Anti-Parallel Diode
 - Switchmode Power Supply
 - Inverters
- Free Wheeling Diode
 - Motor Controllers
 - Converters
 - Inverters
- Snubber Diode
- PFC

PRODUCT FEATURES

- Ultrafast Recovery Times
- Soft Recovery Characteristics
- Popular TO-264 Package
- Low Forward Voltage
- Low Leakage Current

PRODUCT BENEFITS

- Low Losses
- Low Noise Switching
- Cooler Operation
- Higher Reliability Systems
- Increased System Power Density

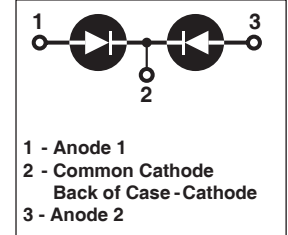
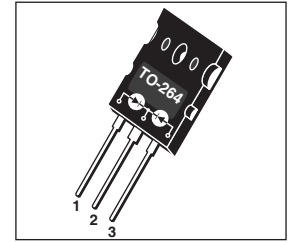

MAXIMUM RATINGS

 All Ratings Per Leg: $T_C = 25^\circ\text{C}$ unless otherwise specified.

Symbol	Characteristic / Test Conditions	APT60D60LCT(G)	UNIT
V_R	Maximum D.C. Reverse Voltage	600	Volts
V_{RRM}	Maximum Peak Repetitive Reverse Voltage		
V_{RWM}	Maximum Working Peak Reverse Voltage		
$I_{F(AV)}$	Maximum Average Forward Current ($T_C = 135^\circ\text{C}$, Duty Cycle = 0.5)	60	Amps
$I_{F(RMS)}$	RMS Forward Current (Square wave, 50% duty)	132	
I_{FSM}	Non-Repetitive Forward Surge Current ($T_J = 45^\circ\text{C}$, 8.3ms)	600	
T_J, T_{STG}	Operating and Storage Temperature Range	-55 to 175	$^\circ\text{C}$
T_L	Lead Temperature for 10 Sec.	300	

STATIC ELECTRICAL CHARACTERISTICS

Symbol	Characteristic / Test Conditions	MIN	TYP	MAX	UNIT	
V_F	Forward Voltage		$I_F = 60\text{A}$	1.6	1.8	Volts
			$I_F = 120\text{A}$	1.9		
			$I_F = 60\text{A}, T_J = 125^\circ\text{C}$	1.4		
I_{RM}	Maximum Reverse Leakage Current		$V_R = 600\text{V}$		250	μA
			$V_R = 600\text{V}, T_J = 125^\circ\text{C}$		500	
C_T	Junction Capacitance, $V_R = 200\text{V}$		90		pF	

DYNAMIC CHARACTERISTICS

APT60D60LCT(G)

Symbol	Characteristic	Test Conditions	MIN	TYP	MAX	UNIT
t_{rr}	Reverse Recovery Time	$I_F = 1A, di_F/dt = -100A/\mu s, V_R = 30V, T_J = 25^\circ C$	-	40		ns
t_{rr}	Reverse Recovery Time	$I_F = 60A, di_F/dt = -200A/\mu s, V_R = 400V, T_C = 25^\circ C$	-	130		
Q_{rr}	Reverse Recovery Charge		-	220		nC
I_{RRM}	Maximum Reverse Recovery Current		-	4	-	Amps
t_{rr}	Reverse Recovery Time	$I_F = 60A, di_F/dt = -200A/\mu s, V_R = 400V, T_C = 125^\circ C$	-	170		ns
Q_{rr}	Reverse Recovery Charge		-	920		nC
I_{RRM}	Maximum Reverse Recovery Current		-	10	-	Amps
t_{rr}	Reverse Recovery Time	$I_F = 60A, di_F/dt = -1000A/\mu s, V_R = 400V, T_C = 125^\circ C$	-	80		ns
Q_{rr}	Reverse Recovery Charge		-	1900		nC
I_{RRM}	Maximum Reverse Recovery Current		-	38		Amps

THERMAL AND MECHANICAL CHARACTERISTICS

Symbol	Characteristic / Test Conditions	MIN	TYP	MAX	UNIT
$R_{\theta JC}$	Junction-to-Case Thermal Resistance			.34	$^\circ C/W$
$R_{\theta JA}$	Junction-to-Ambient Thermal Resistance			40	
W_T	Package Weight		0.22		oz
			5.9		g
Torque	Maximum Mounting Torque			10	lb•in
				1.1	N•m

Microsemi reserves the right to change, without notice, the specifications and information contained herein.

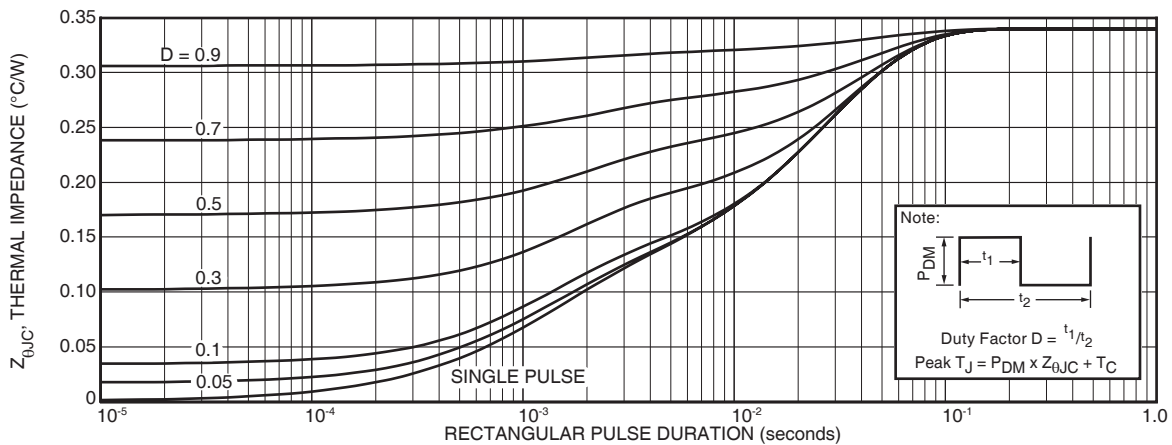

FIGURE 1a. MAXIMUM EFFECTIVE TRANSIENT THERMAL IMPEDANCE, JUNCTION-TO-CASE vs. PULSE DURATION

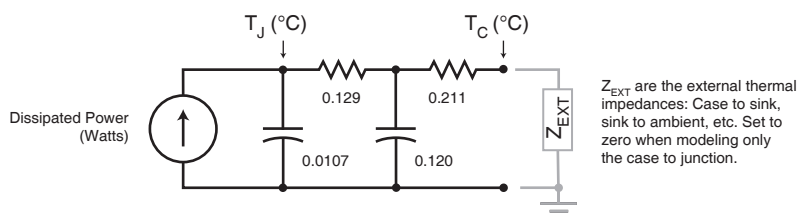

FIGURE 1b, TRANSIENT THERMAL IMPEDANCE MODEL

TYPICAL PERFORMANCE CURVES

APT60D60LCT(G)

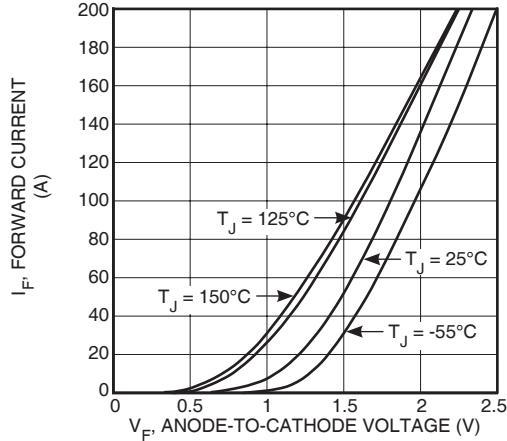

Figure 2. Forward Current vs. Forward Voltage

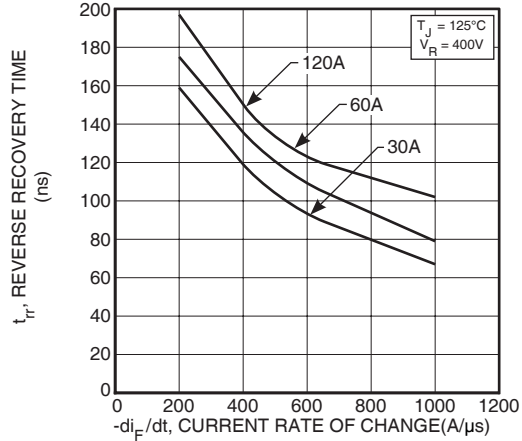

Figure 3. Reverse Recovery Time vs. Current Rate of Change

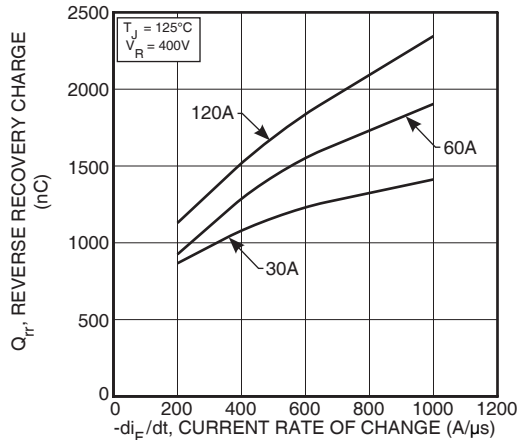

Figure 4. Reverse Recovery Charge vs. Current Rate of Change

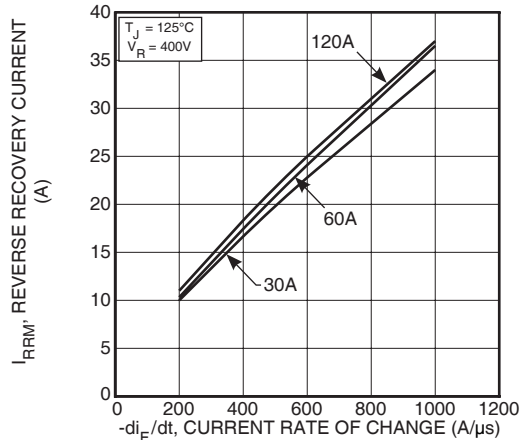

Figure 5. Reverse Recovery Current vs. Current Rate of Change

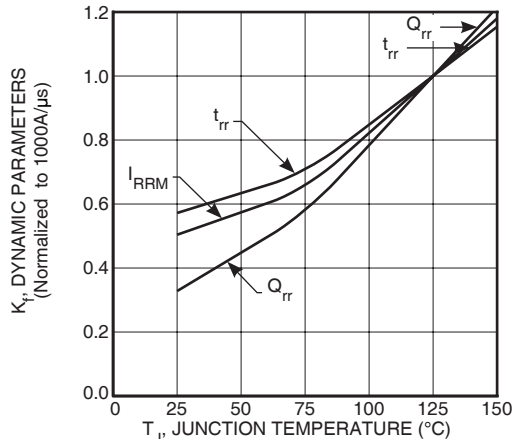

Figure 6. Dynamic Parameters vs. Junction Temperature

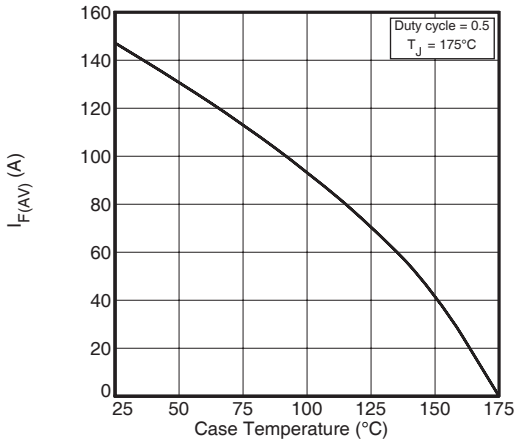

Figure 7. Maximum Average Forward Current vs. Case Temperature

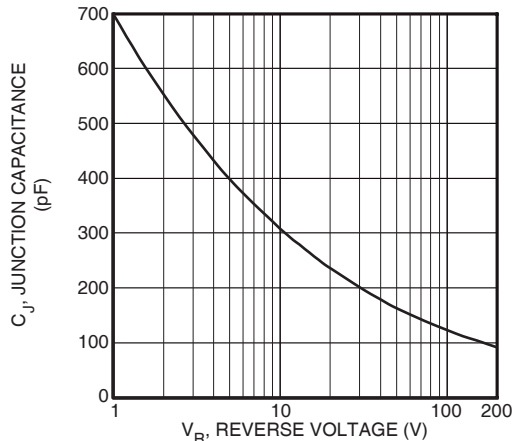

Figure 8. Junction Capacitance vs. Reverse Voltage

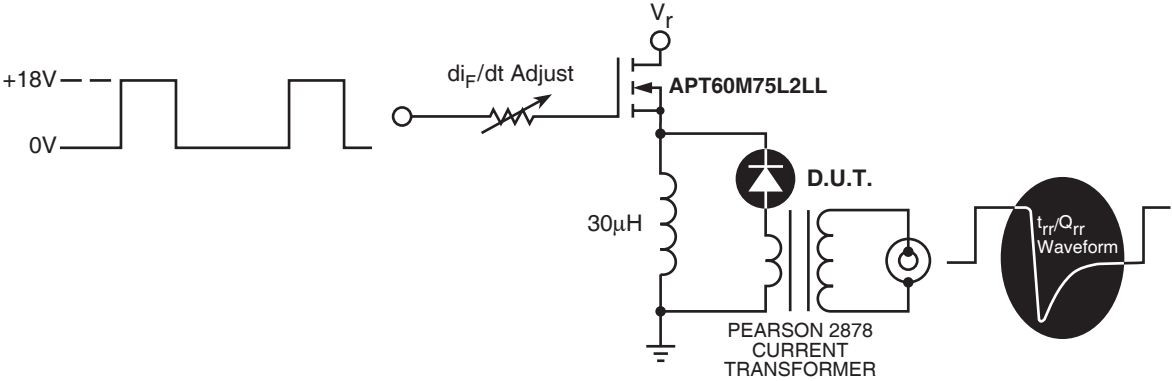

Figure 9. Diode Test Circuit

- 1 I_F - Forward Conduction Current
- 2 di_F/dt - Rate of Diode Current Change Through Zero Crossing.
- 3 I_{RRM} - Maximum Reverse Recovery Current.
- 4 t_{rr} - Reverse Recovery Time, measured from zero crossing where diode current goes from positive to negative, to the point at which the straight line through I_{RRM} and $0.25 \cdot I_{RRM}$ passes through zero.
- 5 Q_{rr} - Area Under the Curve Defined by I_{RRM} and t_{rr} .

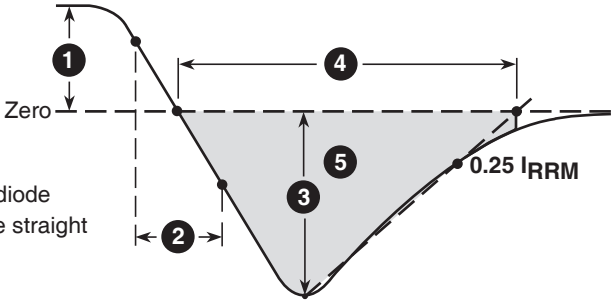
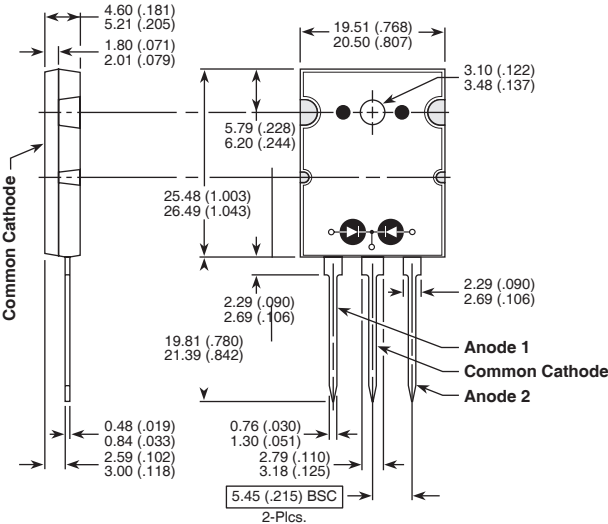

Figure 10, Diode Reverse Recovery Waveform and Definitions

TO-264 (LCT) Package Outline

(e1) SAC: Tin, Silver, Copper



Dimensions in Millimeters and (Inches)