



Chipsmall Limited consists of a professional team with an average of over 10 year of expertise in the distribution of electronic components. Based in Hongkong, we have already established firm and mutual-benefit business relationships with customers from,Europe,America and south Asia,supplying obsolete and hard-to-find components to meet their specific needs.

With the principle of “Quality Parts,Customers Priority,Honest Operation,and Considerate Service”,our business mainly focus on the distribution of electronic components. Line cards we deal with include Microchip,ALPS,ROHM,Xilinx,Pulse,ON,Everlight and Freescale. Main products comprise IC,Modules,Potentiometer,IC Socket,Relay,Connector.Our parts cover such applications as commercial,industrial, and automotives areas.

We are looking forward to setting up business relationship with you and hope to provide you with the best service and solution. Let us make a better world for our industry!



Contact us

Tel: +86-755-8981 8866 Fax: +86-755-8427 6832

Email & Skype: info@chipsmall.com Web: www.chipsmall.com

Address: A1208, Overseas Decoration Building, #122 Zhenhua RD., Futian, Shenzhen, China



**Full – Bridge + boost chopper
CoolMOS™ & Trench + Field Stop IGBT3
Power module**

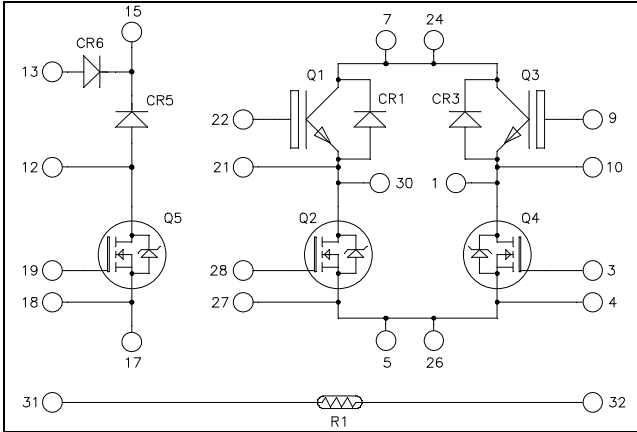

Top switches : Trench + Field Stop IGBT3
 Bottom switches : CoolMOS™
 Boost chopper : CoolMOS™

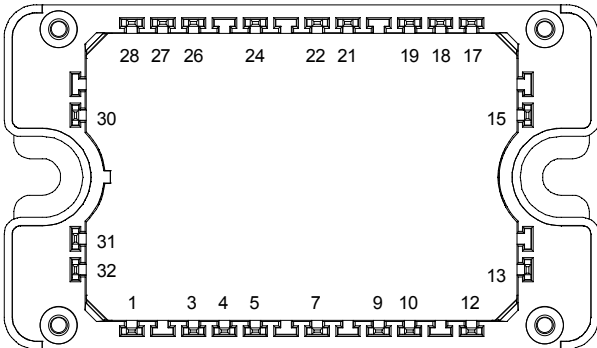

All multiple inputs and outputs must be shorted together
 7/24 ; 5/26

Trench & Field Stop IGBT3 Q1, Q3:
 $V_{CES} = 600V$; $I_C = 50A$ @ $T_c = 80^\circ C$

CoolMOS™ Q2, Q4:
 $V_{DSS} = 600V$
 $R_{DSon} = 45m\Omega$ max @ $T_j = 25^\circ C$

Application

- Solar converter

Features

- **Q2, Q4 & Q5 CoolMOS™**
 - Ultra low R_{DSon}
 - Low Miller capacitance
 - Ultra low gate charge
 - Avalanche energy rated
- **Q1, Q3 Trench & Field Stop IGBT3**
 - Low voltage drop
 - Switching frequency up to 20 kHz
 - RBSOA & SCSOA rated
 - Low tail current
- **FWD SiC Schottky Diode (CR5)**
 - Zero reverse recovery
 - Zero forward recovery
 - Temperature Independent switching behavior
 - Positive temperature coefficient on VF
- Very low stray inductance
- Kelvin source for easy drive
- Internal thermistor for temperature monitoring
- High level of integration

Benefits

- Optimized conduction & switching losses
- Direct mounting to heatsink (isolated package)
- Low junction to case thermal resistance
- Solderable terminals both for power and signal for easy PCB mounting
- Low profile
- Easy paralleling due to positive T_C of V_{CEsat}
- RoHS Compliant

CAUTION: These Devices are sensitive to Electrostatic Discharge. Proper Handling Procedures Should Be Followed. See application note APT0502 on www.microsemi.com

All ratings @ $T_j = 25^\circ C$ unless otherwise specified

1. Top switches
1.1 Top Trench + Field Stop IGBT3 characteristics (per IGBT)
Electrical Characteristics

Symbol	Characteristic	Test Conditions	Min	Typ	Max	Unit
I_{CES}	Zero Gate Voltage Collector Current	$V_{GE} = 0V, V_{CE} = 600V$			250	μA
$V_{CE(sat)}$	Collector Emitter Saturation Voltage	$V_{GE} = 15V$ $I_C = 50A$		1.5 1.7	1.9	V
		$T_j = 25^\circ C$ $T_j = 150^\circ C$				
$V_{GE(th)}$	Gate Threshold Voltage	$V_{GE} = V_{CE}, I_C = 600\mu A$	5.0	5.8	6.5	V
I_{GES}	Gate – Emitter Leakage Current	$V_{GE} = 20V, V_{CE} = 0V$			600	nA

Dynamic Characteristics

Symbol	Characteristic	Test Conditions	Min	Typ	Max	Unit
C_{ies}	Input Capacitance	$V_{GE} = 0V$		3150		pF
C_{oes}	Output Capacitance	$V_{CE} = 25V$		200		
C_{res}	Reverse Transfer Capacitance	$f = 1MHz$		95		
Q_G	Gate charge	$V_{GE} = \pm 15V, I_C = 50A$ $V_{CE} = 300V$		0.5		μC
$T_{d(on)}$	Turn-on Delay Time	Inductive Switching (25°C) $V_{GE} = \pm 15V$ $V_{Bus} = 300V$ $I_C = 50A$ $R_G = 8.2\Omega$		110		ns
T_r	Rise Time			45		
$T_{d(off)}$	Turn-off Delay Time			200		
T_f	Fall Time			40		
$T_{d(on)}$	Turn-on Delay Time	Inductive Switching (150°C) $V_{GE} = \pm 15V$ $V_{Bus} = 300V$ $I_C = 50A$ $R_G = 8.2\Omega$		120		ns
T_r	Rise Time			50		
$T_{d(off)}$	Turn-off Delay Time			250		
T_f	Fall Time			60		
E_{off}	Turn-off Switching Energy	$V_{GE} = \pm 15V$ $V_{Bus} = 300V$ $I_C = 50A$ $R_G = 8.2\Omega$		1.35 1.75		mJ
		$T_j = 25^\circ C$ $T_j = 150^\circ C$				
I_{sc}	Short Circuit data	$V_{GE} \leq 15V; V_{Bus} = 360V$ $t_p \leq 6\mu s; T_j = 150^\circ C$		250		A
R_{thJC}	Junction to Case Thermal resistance				0.85	$^\circ C/W$

1.2 Top diode characteristics (CR1, CR3) (per diode)

<i>Symbol</i>	<i>Characteristic</i>	<i>Test Conditions</i>		<i>Min</i>	<i>Typ</i>	<i>Max</i>	<i>Unit</i>
V _{RRM}	Maximum Peak Repetitive Reverse Voltage			600			V
I _{RM}	Maximum Reverse Leakage Current	V _R =600V	T _j = 25°C			25	μA
			T _j = 125°C			500	
I _F	DC Forward Current		T _c = 80°C		25		A
V _F	Diode Forward Voltage	I _F = 25A			1.8	2.2	V
		I _F = 50A			2.2		
		I _F = 25A	T _j = 125°C		1.6		
t _{rr}	Reverse Recovery Time	I _F = 25A V _R = 400V di/dt = 200A/μs	T _j = 25°C		30		ns
			T _j = 125°C		175		
Q _{rr}	Reverse Recovery Charge	I _F = 25A V _R = 400V di/dt = 200A/μs	T _j = 25°C		55		nC
			T _j = 125°C		485		
R _{thJC}	Junction to Case Thermal resistance					1.4	°C/W

2. Bottom switches
2.1 Bottom CoolMOS™ characteristics (Per CoolMOS™)
Absolute maximum ratings

<i>Symbol</i>	<i>Parameter</i>	<i>Max ratings</i>	<i>Unit</i>
V _{DSS}	Drain - Source Breakdown Voltage	600	V
I _D	Continuous Drain Current	T _c = 25°C	49
		T _c = 80°C	38
I _{DM}	Pulsed Drain current	130	A
V _{GS}	Gate - Source Voltage	±20	V
R _{DS(on)}	Drain - Source ON Resistance	45	mΩ
P _D	Maximum Power Dissipation	T _c = 25°C	250
I _{AR}	Avalanche current (repetitive and non repetitive)	15	A
E _{AR}	Repetitive Avalanche Energy	3	mJ
E _{AS}	Single Pulse Avalanche Energy	1900	

Electrical Characteristics

<i>Symbol</i>	<i>Characteristic</i>	<i>Test Conditions</i>	<i>Min</i>	<i>Typ</i>	<i>Max</i>	<i>Unit</i>
I _{DSS}	Zero Gate Voltage Drain Current	V _{GS} = 0V, V _{DS} = 600V	T _j = 25°C		250	μA
		V _{GS} = 0V, V _{DS} = 600V	T _j = 125°C		500	
R _{DS(on)}	Drain - Source on Resistance	V _{GS} = 10V, I _D = 24.5A		40	45	mΩ
V _{GS(th)}	Gate Threshold Voltage	V _{GS} = V _{DS} , I _D = 3mA	2.1	3	3.9	V
I _{GSS}	Gate - Source Leakage Current	V _{GS} = ±20 V, V _{DS} = 0V			100	nA

Dynamic Characteristics

Symbol	Characteristic	Test Conditions	Min	Typ	Max	Unit
C _{iss}	Input Capacitance	V _{GS} = 0V ; V _{DS} = 25V f = 1MHz		7.2		nF
C _{oss}	Output Capacitance			8.5		
Q _g	Total gate Charge	V _{GS} = 10V V _{Bus} = 300V I _D = 49A		150		nC
Q _{gs}	Gate – Source Charge			34		
Q _{gd}	Gate – Drain Charge			51		
T _{d(on)}	Turn-on Delay Time	Inductive Switching (125°C) V _{GS} = 10V V _{Bus} = 400V I _D = 49A R _G = 5Ω		21		ns
T _r	Rise Time			30		
T _{d(off)}	Turn-off Delay Time			100		
T _f	Fall Time			45		
E _{on}	Turn-on Switching Energy	Inductive switching @ 25°C V _{GS} = 10V ; V _{Bus} = 400V I _D = 49A ; R _G = 5Ω		675		μJ
E _{off}	Turn-off Switching Energy			520		
E _{on}	Turn-on Switching Energy	Inductive switching @ 125°C V _{GS} = 10V ; V _{Bus} = 400V I _D = 49A ; R _G = 5Ω		1096		μJ
E _{off}	Turn-off Switching Energy			635		
R _{thJC}	Junction to Case Thermal resistance				0.5	°C/W

Source - Drain diode ratings and characteristics

Symbol	Characteristic	Test Conditions	Min	Typ	Max	Unit
I _S	Continuous Source current (Body diode)	T _c = 25°C		49		A
		T _c = 80°C		38		
V _{SD}	Diode Forward Voltage	V _{GS} = 0V, I _S = - 49A			1.2	V
dv/dt	Peak Diode Recovery ❶				4	V/ns
t _{rr}	Reverse Recovery Time	I _S = - 49A V _R = 350V di/dt = 100A/μs	T _j = 25°C		600	ns
Q _{rr}	Reverse Recovery Charge		T _j = 25°C		17	μC

❶ dv/dt numbers reflect the limitations of the circuit rather than the device itself.

$$I_S \leq -49A \quad di/dt \leq 100A/\mu s \quad V_R \leq V_{DSS} \quad T_j \leq 150^\circ C$$

3. Boost chopper Q5, CR5

3.1 Q5 CoolMOS™ characteristics

Absolute maximum ratings

Symbol	Parameter	Max ratings	Unit
V _{DSS}	Drain - Source Breakdown Voltage	600	V
I _D	Continuous Drain Current	T _c = 25°C	49
		T _c = 80°C	38
I _{DM}	Pulsed Drain current	130	
V _{GS}	Gate - Source Voltage	±20	V
R _{DSon}	Drain - Source ON Resistance	45	mΩ
P _D	Maximum Power Dissipation	T _c = 25°C	250
I _{AR}	Avalanche current (repetitive and non repetitive)	15	A
E _{AR}	Repetitive Avalanche Energy	3	mJ
E _{AS}	Single Pulse Avalanche Energy	1900	

Electrical Characteristics

Symbol	Characteristic	Test Conditions	Min	Typ	Max	Unit
I _{DSS}	Zero Gate Voltage Drain Current	V _{GS} = 0V, V _{DS} = 600V			250	μA
		T _j = 25°C				
		V _{GS} = 0V, V _{DS} = 600V			500	
R _{DS(on)}	Drain – Source on Resistance	V _{GS} = 10V, I _D = 24.5A		40	45	mΩ
V _{GS(th)}	Gate Threshold Voltage	V _{GS} = V _{DS} , I _D = 3mA	2.1	3	3.9	V
I _{GSS}	Gate – Source Leakage Current	V _{GS} = ±20 V, V _{DS} = 0V			100	nA

Dynamic Characteristics

Symbol	Characteristic	Test Conditions	Min	Typ	Max	Unit
C _{iss}	Input Capacitance	V _{GS} = 0V ; V _{DS} = 25V f = 1MHz		7.2		nF
C _{oss}	Output Capacitance			8.5		
Q _g	Total gate Charge	V _{GS} = 10V V _{Bus} = 300V I _D = 49A		150		nC
Q _{gs}	Gate – Source Charge			34		
Q _{gd}	Gate – Drain Charge			51		
T _{d(on)}	Turn-on Delay Time	Inductive Switching (125°C) V _{GS} = 10V V _{Bus} = 400V I _D = 49A R _G = 5Ω		21		ns
T _r	Rise Time			30		
T _{d(off)}	Turn-off Delay Time			100		
T _f	Fall Time			45		
E _{on}	Turn-on Switching Energy	Inductive switching @ 25°C V _{GS} = 10V ; V _{Bus} = 400V I _D = 49A ; R _G = 5Ω		405		μJ
E _{off}	Turn-off Switching Energy			520		
E _{on}	Turn-on Switching Energy	Inductive switching @ 125°C V _{GS} = 10V ; V _{Bus} = 400V I _D = 49A ; R _G = 5Ω		658		μJ
E _{off}	Turn-off Switching Energy			635		
R _{thJC}	Junction to Case Thermal resistance				0.5	°C/W

Source - Drain diode ratings and characteristics

Symbol	Characteristic	Test Conditions	Min	Typ	Max	Unit
I _S	Continuous Source current (Body diode)	T _c = 25°C		49		A
		T _c = 80°C		38		
V _{SD}	Diode Forward Voltage	V _{GS} = 0V, I _S = - 49A			1.2	V
dv/dt	Peak Diode Recovery ❶				4	V/ns
t _{rr}	Reverse Recovery Time	I _S = - 49A V _R = 350V di _S /dt = 100A/μs		600		ns
Q _{rr}	Reverse Recovery Charge		T _j = 25°C		17	

❶ dv/dt numbers reflect the limitations of the circuit rather than the device itself.

$$I_S \leq -49A \quad di/dt \leq 100A/\mu s \quad V_R \leq V_{DSS} \quad T_j \leq 150^\circ C$$

3.2 SiC Chopper diode characteristics (CR5)

Symbol	Characteristic	Test Conditions	Min	Typ	Max	Unit
V _{RRM}	Maximum Peak Repetitive Reverse Voltage		600			V
I _{RM}	Maximum Reverse Leakage Current	V _R =600V		20	120	μA
				40	600	
I _F	DC Forward Current			20		A
V _F	Diode Forward Voltage	I _F = 20A		1.6	1.8	V
				2	2.4	
Q _C	Total Capacitive Charge	I _F = 20A, V _R = 300V di/dt = 800A/μs		28		nC
C	Total Capacitance	f = 1MHz, V _R = 200V		130		pF
		f = 1MHz, V _R = 400V		100		
R _{thJC}	Junction to Case Thermal resistance				1.5	°C/W

4. By pass diode (CR6)

Absolute maximum ratings

Symbol	Parameter	Max ratings	Unit
V _R	Maximum DC reverse Voltage	1600	V
V _{RRM}	Maximum Peak Repetitive Reverse Voltage		
I _F	DC Forward Current	40	A
I _{FSM}	Non-Repetitive Forward Surge Current	400	

Electrical Characteristics

Symbol	Characteristic	Test Conditions	Min	Typ	Max	Unit
I _R	Reverse Current	V _R = 1600V		20		μA
				2		mA
V _F	Forward Voltage	I _F = 40A		1.3		V
				1.1		
V _T	On – state Voltage			0.8		V
r _T	On – state Slope resistance			10.5		mΩ
R _{thJC}	Junction to Case Thermal resistance				1.5	°C/W

5. Temperature sensor

Temperature sensor NTC (see application note APT0406 on www.microsemi.com for more information).

Symbol	Characteristic	Min	Typ	Max	Unit
R ₂₅	Resistance @ 25°C		50		kΩ
ΔR ₂₅ /R ₂₅			5		%
B _{25/85}	T ₂₅ = 298.15 K		3952		K
ΔB/B			4		%

$$R_T = \frac{R_{25}}{\exp \left[B_{25/85} \left(\frac{1}{T} - \frac{1}{T_{25}} \right) \right]}$$

T: Thermistor temperature
 R_T: Thermistor value at T

6. Package characteristics

Symbol	Characteristic	Min	Typ	Max	Unit	
V _{ISOL}	RMS Isolation Voltage, any terminal to case t=1 min, 50/60Hz	4000			V	
T _J	Operating junction temperature range	-40		150*	°C	
T _{STG}	Storage Temperature Range	-40		125		
T _C	Operating Case Temperature	-40		100		
3	Mounting torque	To heatsink	M4	2	3	N.m
Wt	Package Weight				110	g

* T_j=175°C for Trench & Field Stop IGBT3

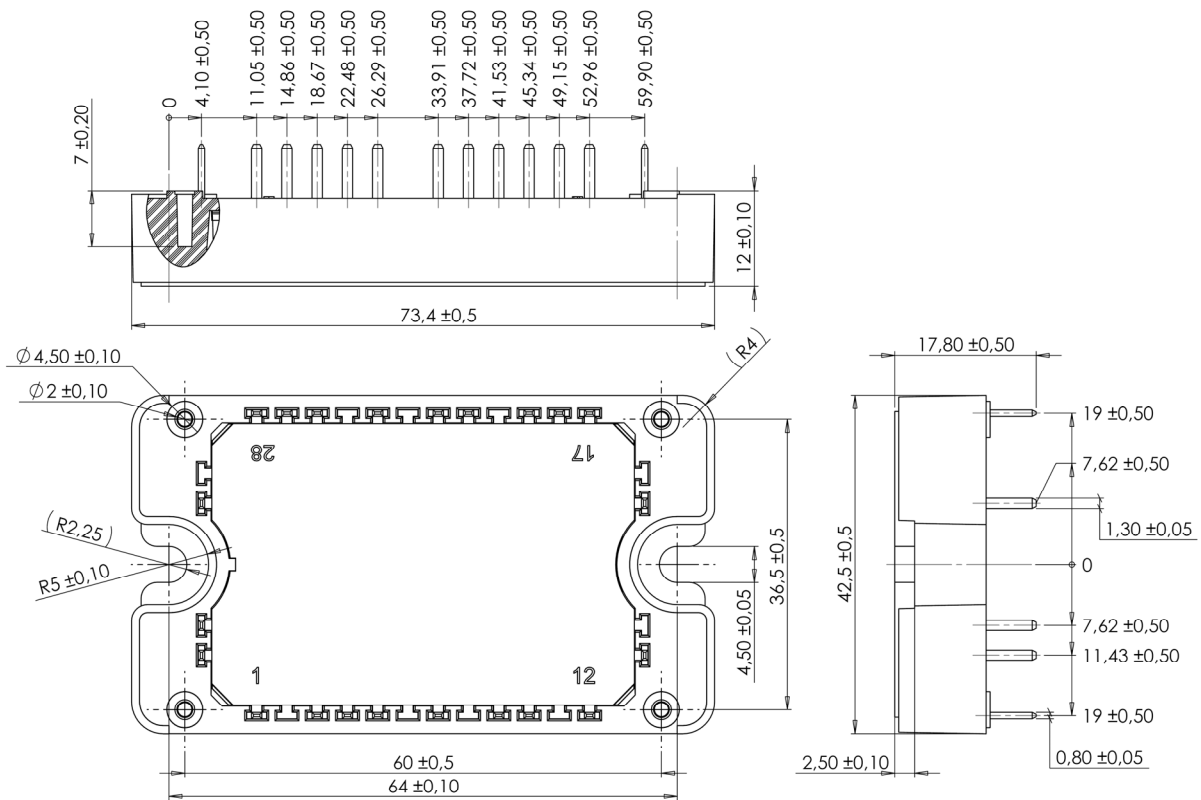
7. SP3 Package outline (dimensions in mm)

8. Top switches curves

8.1 Top Trench + Field Stop IGBT3 typical performance curves (per IGBT)

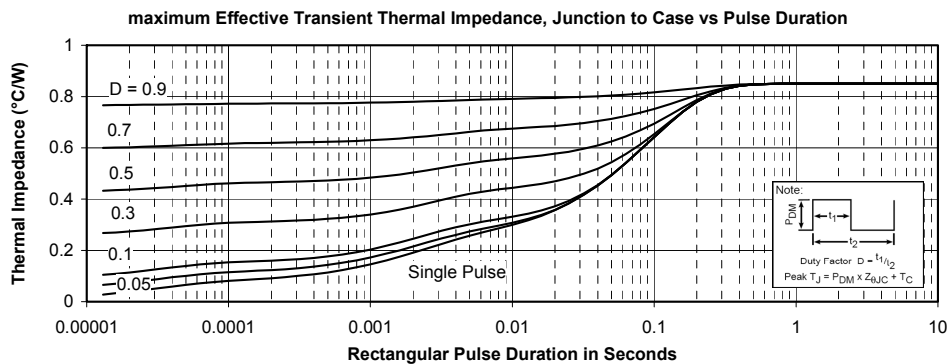
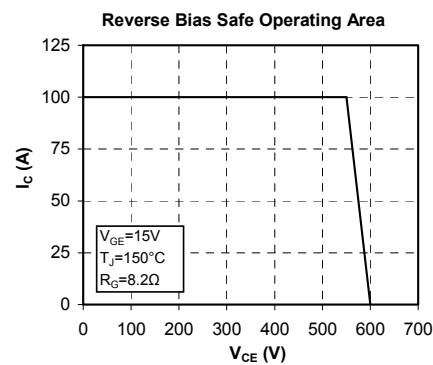
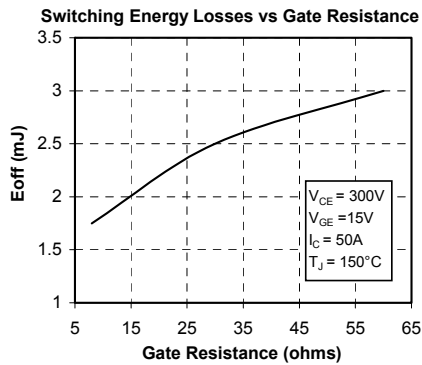
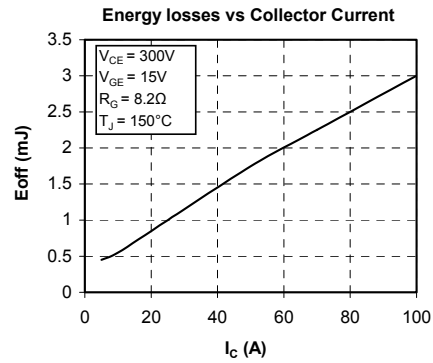
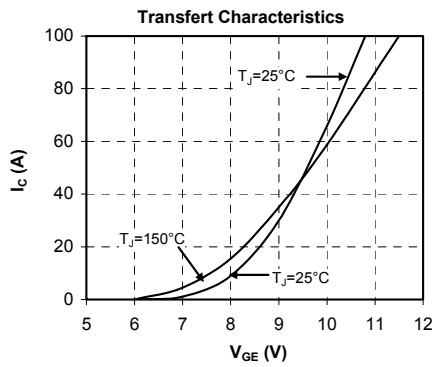
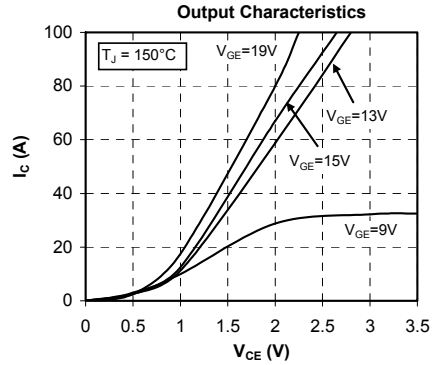
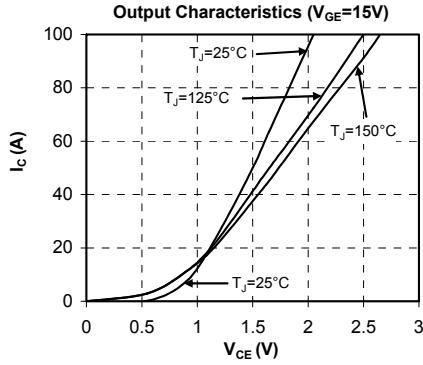

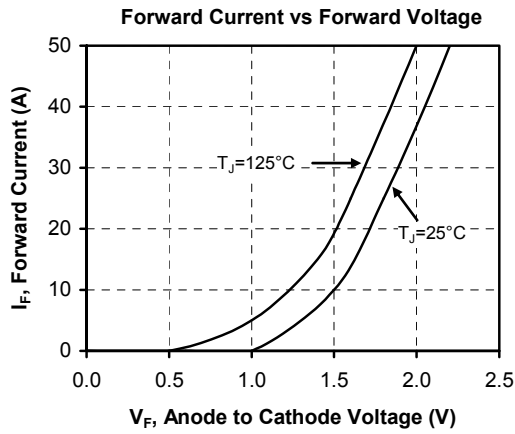
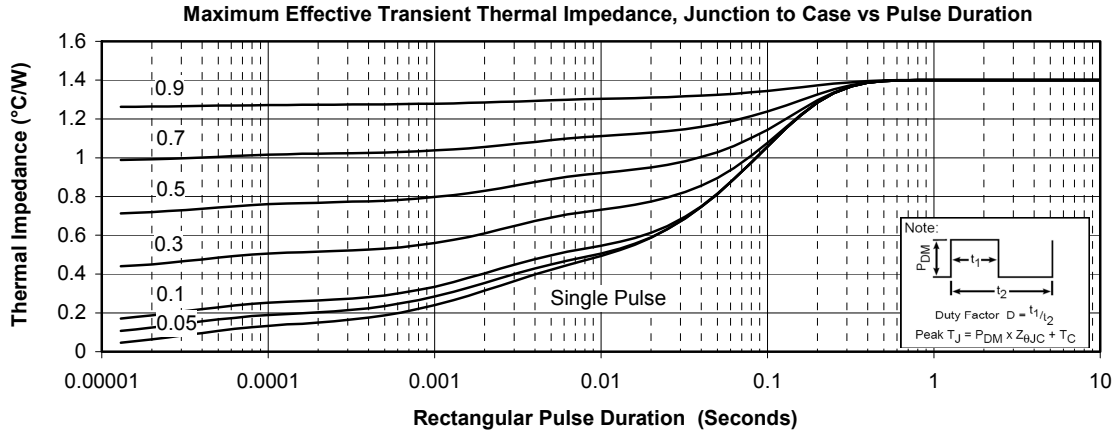
8.2 Top diode characteristics (CR1, CR3) (per diode)

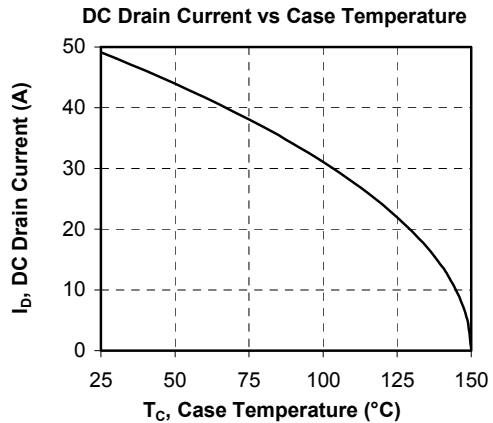
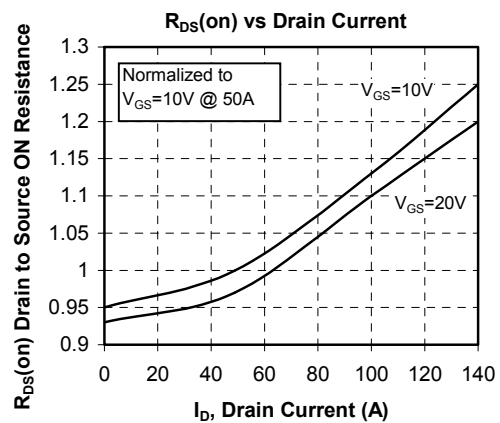
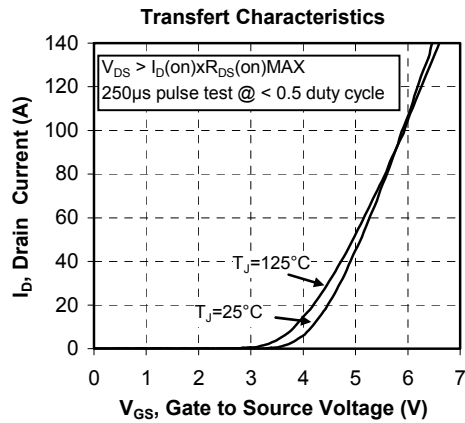
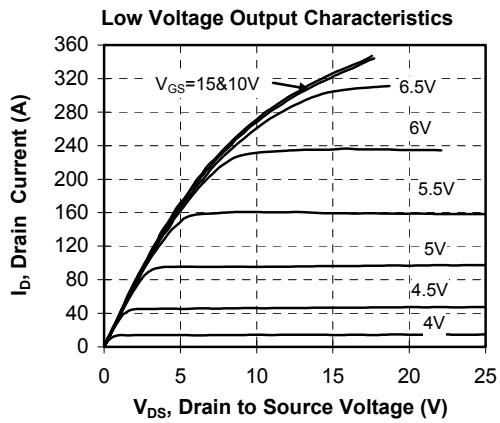
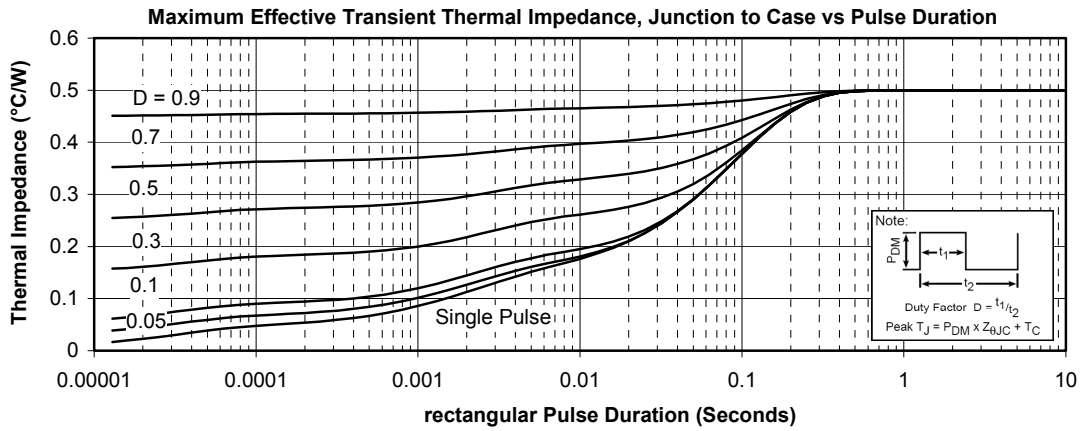
9. Bottom CoolMOST™ switches curves (per CoolMOST™)

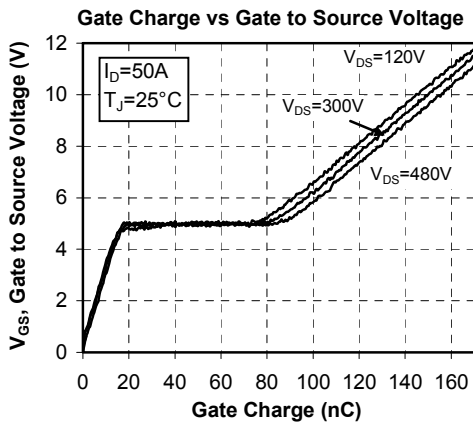
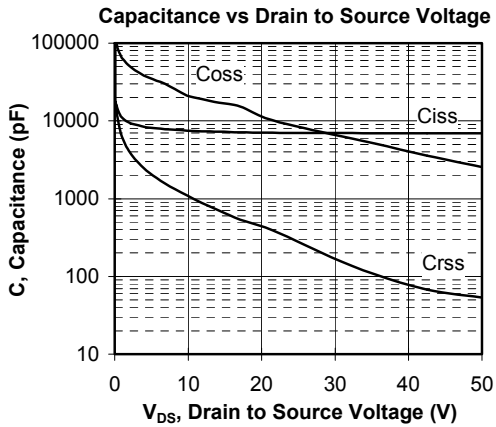
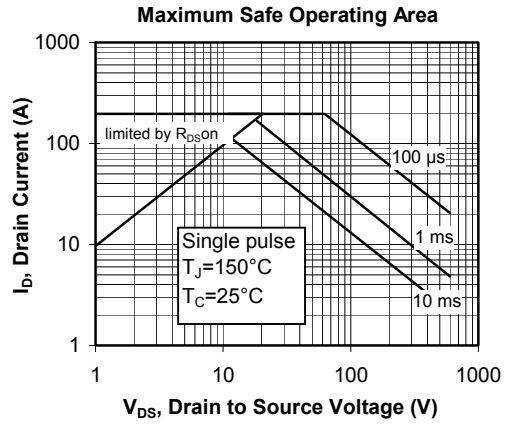
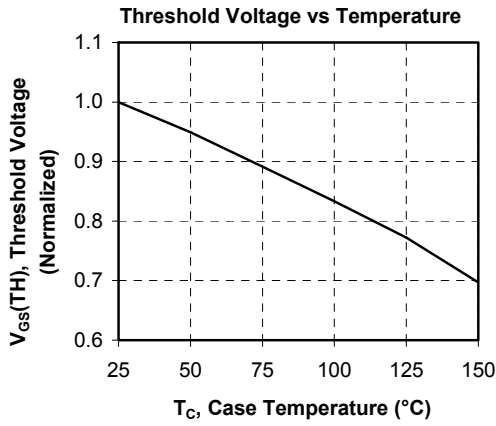
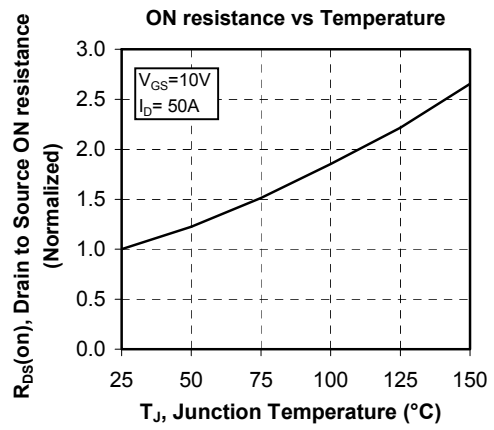
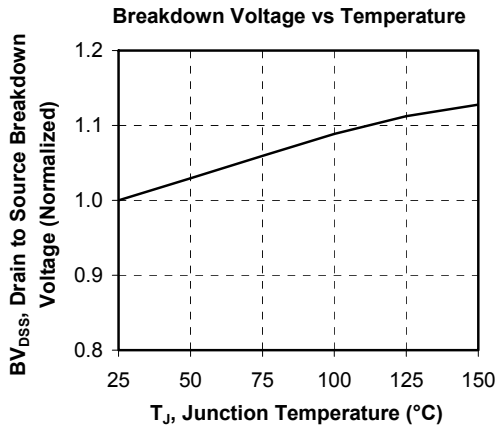

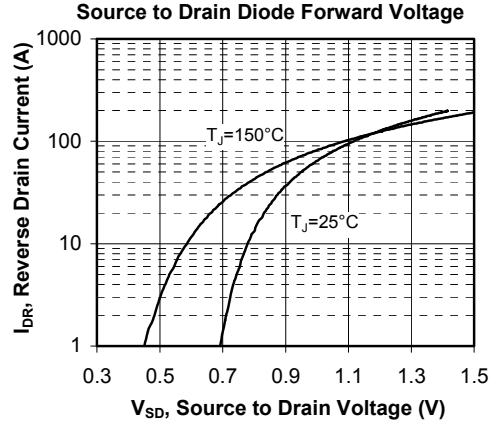
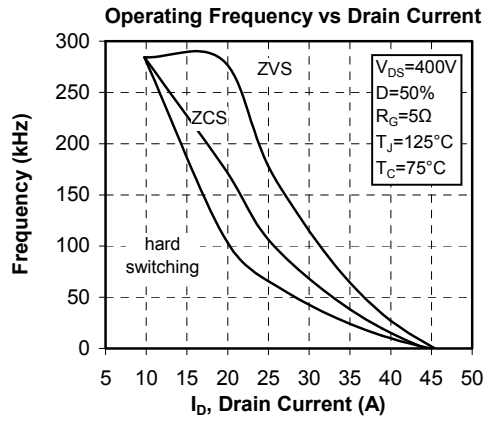
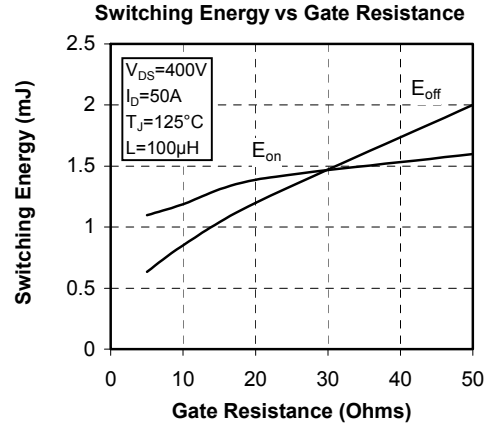
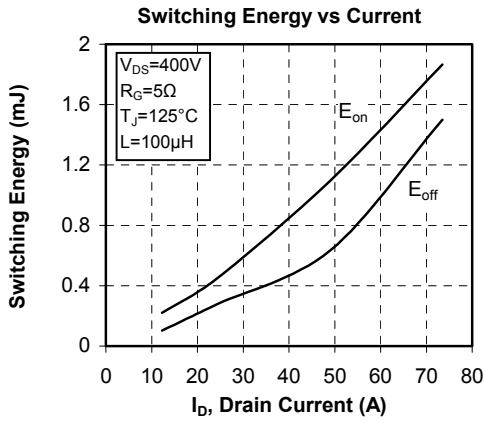
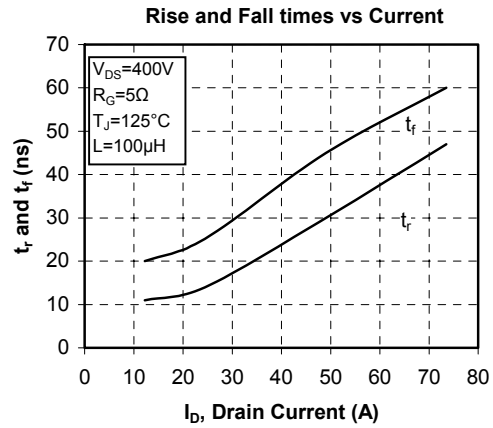
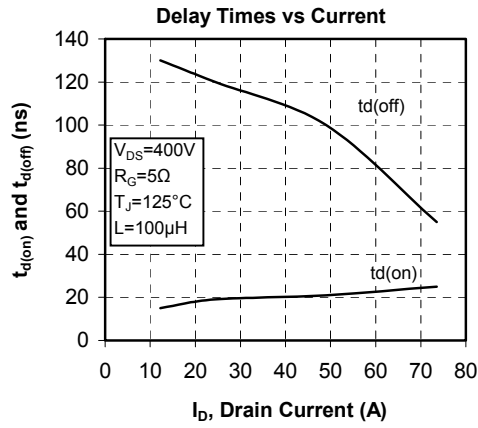

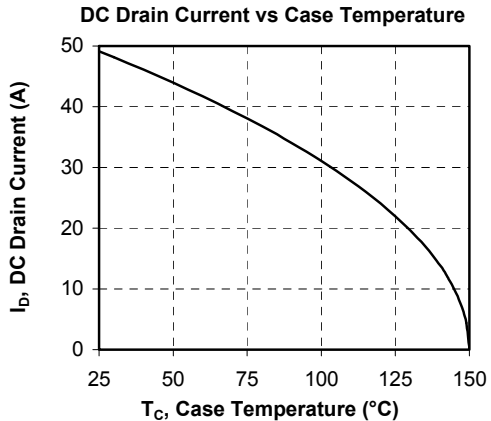
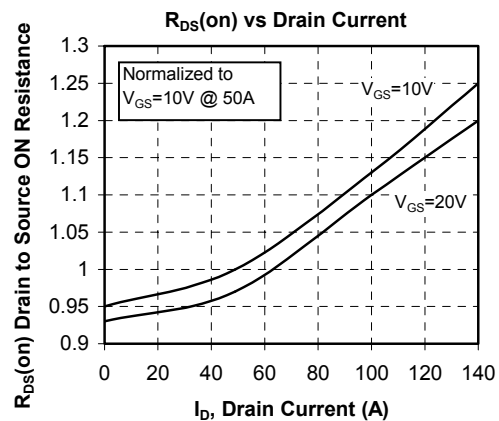
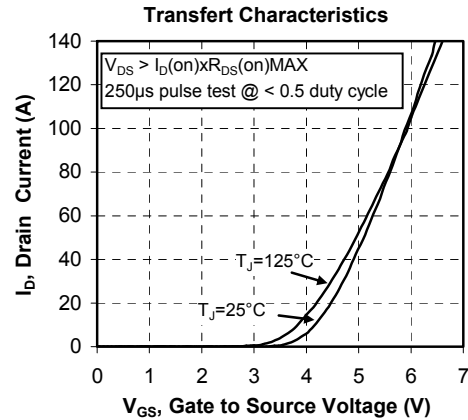
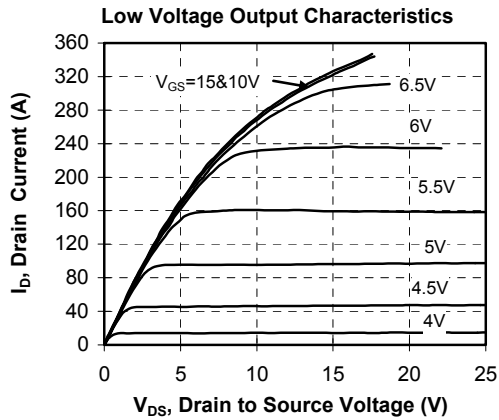
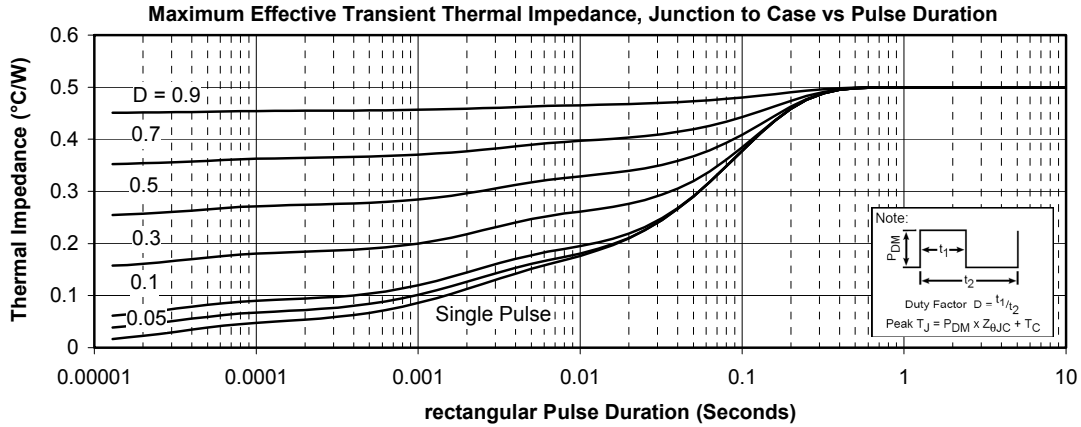
10. CoolMOS™ chopper curves

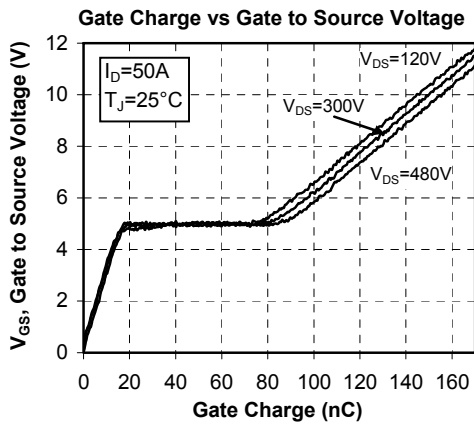
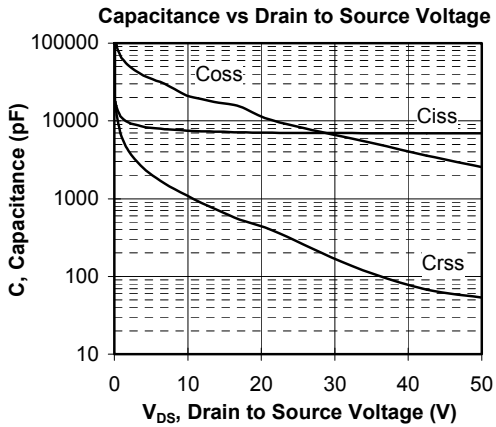
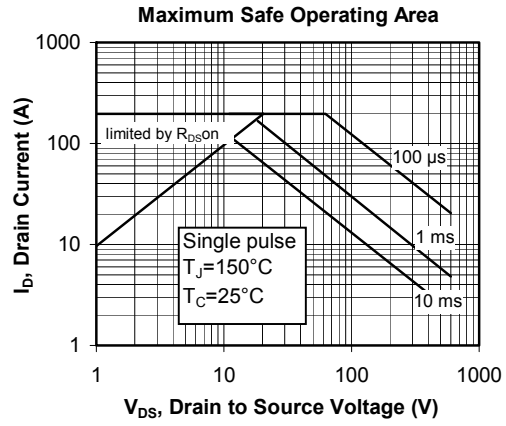
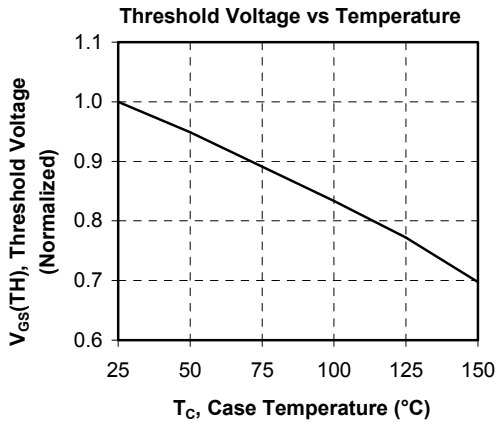
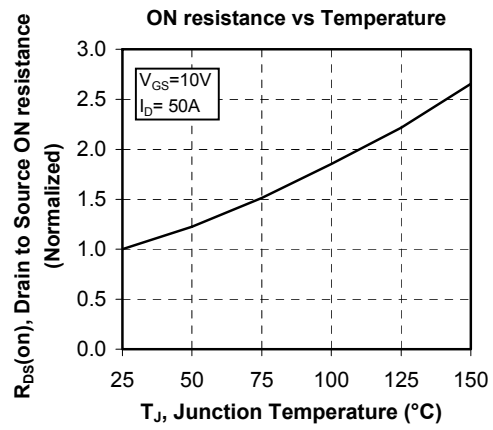
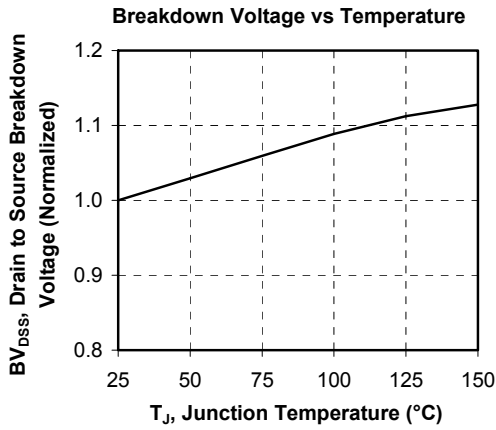

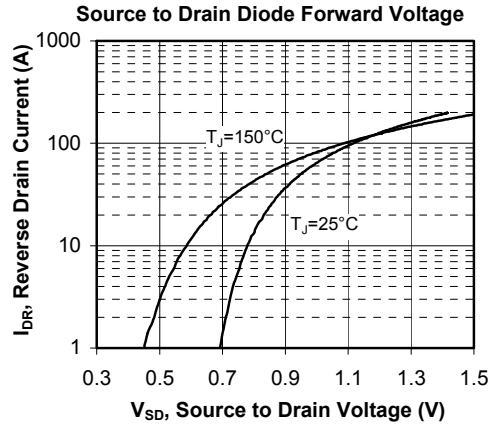
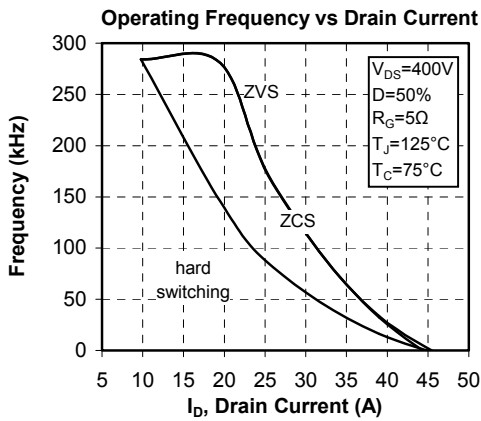
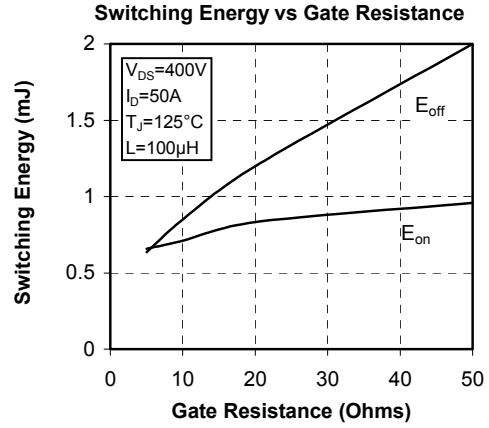
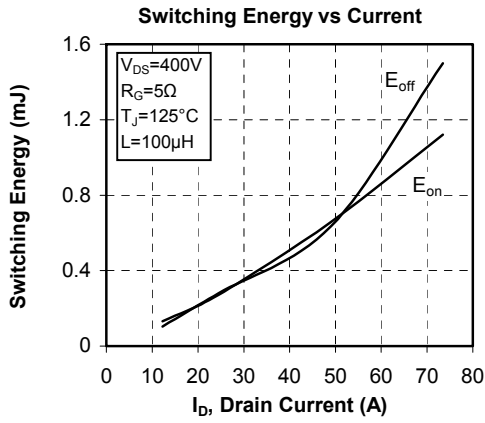
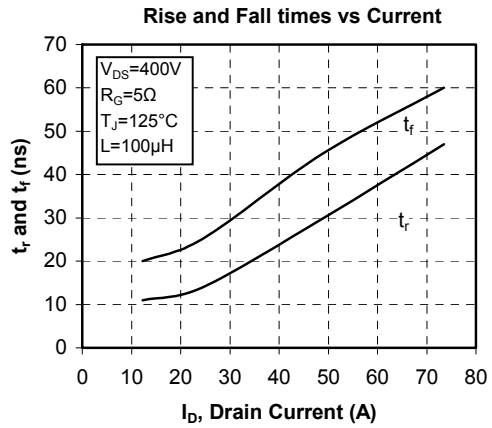
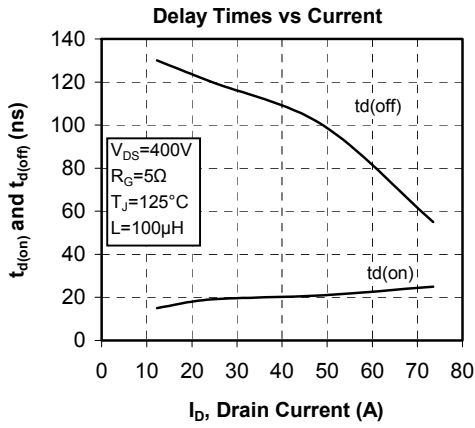

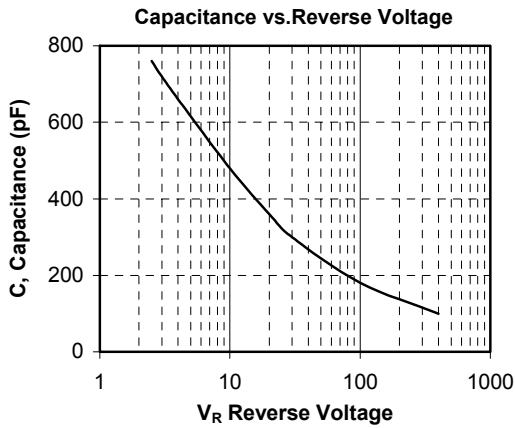
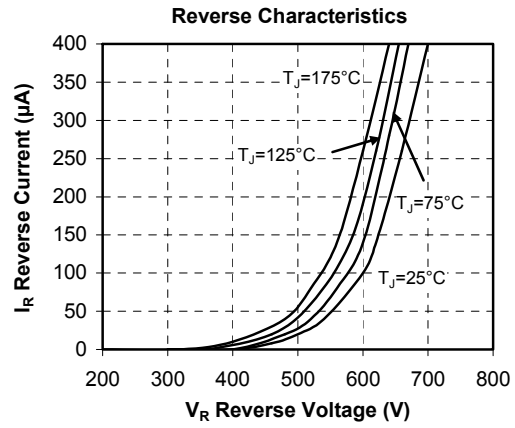
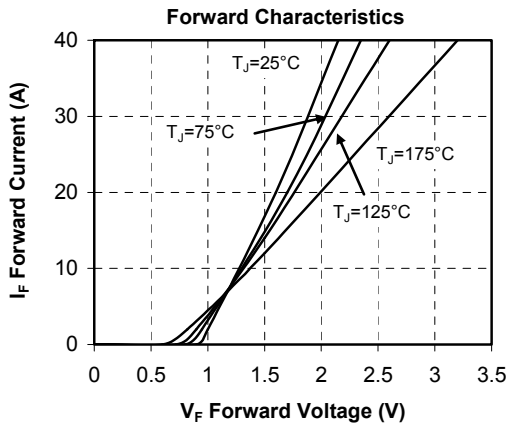
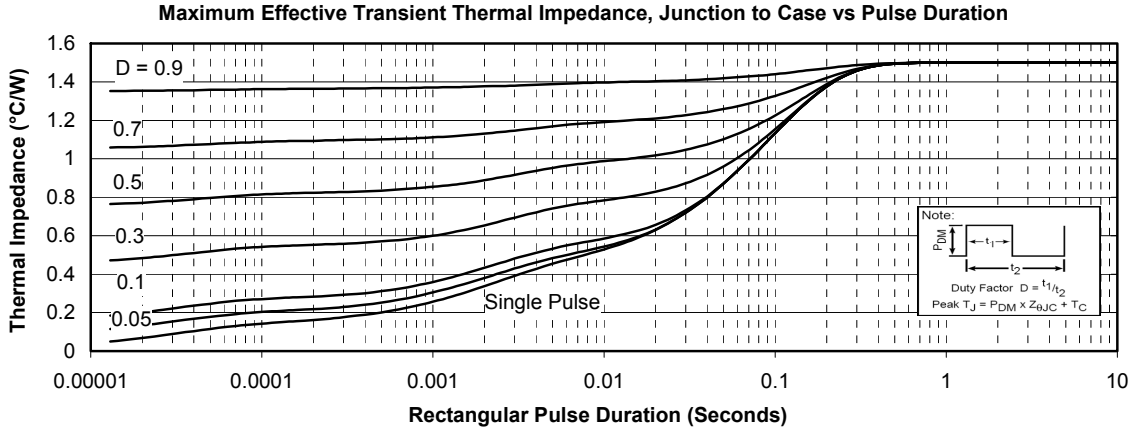
11. Chopper SiC diode curves

12. Typical by pass CR6 diode curves

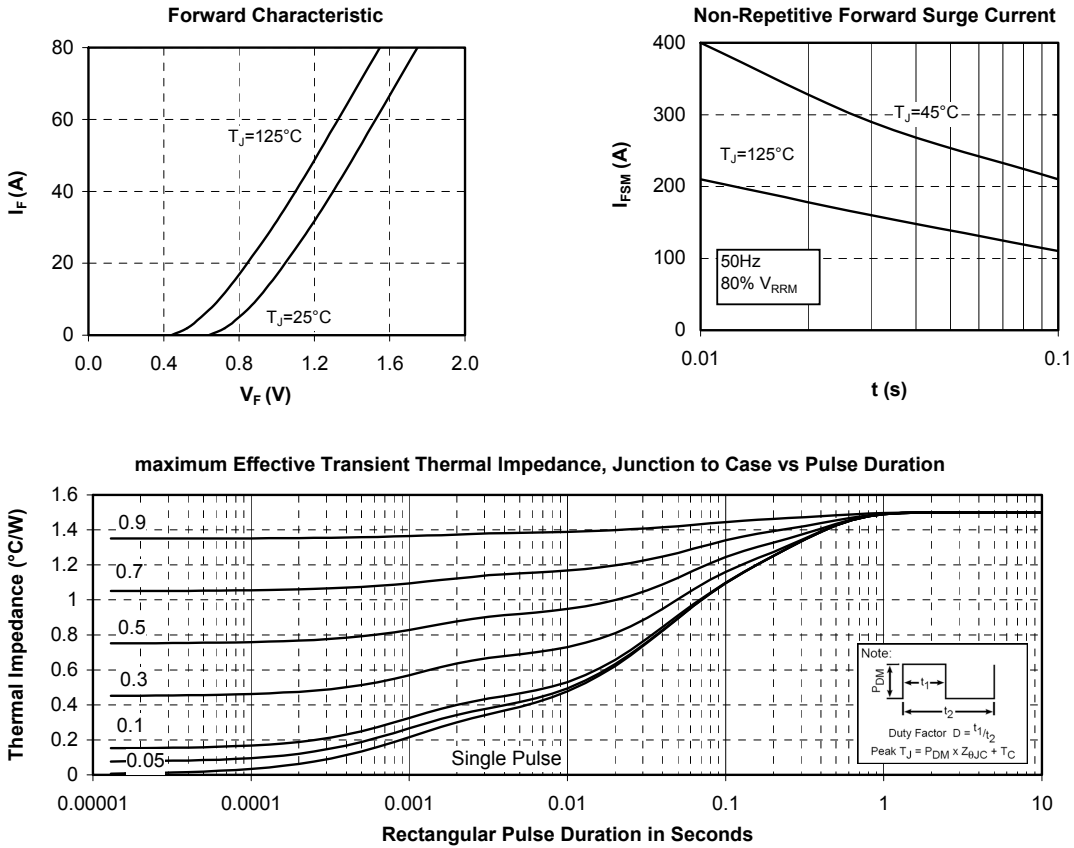

“COOLMOS™” comprise a new family of transistors developed by Infineon Technologies AG. “COOLMOS” is a trademark of Infineon Technologies AG”.

DISCLAIMER

The information contained in the document (unless it is publicly available on the Web without access restrictions) is PROPRIETARY AND CONFIDENTIAL information of Microsemi and cannot be copied, published, uploaded, posted, transmitted, distributed or disclosed or used without the express duly signed written consent of Microsemi. If the recipient of this document has entered into a disclosure agreement with Microsemi, then the terms of such Agreement will also apply. This document and the information contained herein may not be modified, by any person other than authorized personnel of Microsemi. No license under any patent, copyright, trade secret or other intellectual property right is granted to or conferred upon you by disclosure or delivery of the information, either expressly, by implication, inducement, estoppels or otherwise. Any license under such intellectual property rights must be approved by Microsemi in writing signed by an officer of Microsemi.

Microsemi reserves the right to change the configuration, functionality and performance of its products at anytime without any notice. This product has been subject to limited testing and should not be used in conjunction with life-support or other mission-critical equipment or applications. Microsemi assumes no liability whatsoever, and Microsemi disclaims any express or implied warranty, relating to sale and/or use of Microsemi products including liability or warranties relating to fitness for a particular purpose, merchantability, or infringement of any patent, copyright or other intellectual property right. Any performance specifications believed to be reliable but are not verified and customer or user must conduct and complete all performance and other testing of this product as well as any user or customers final application. User or customer shall not rely on any data and performance specifications or parameters provided by Microsemi. It is the customer's and user's responsibility to independently determine suitability of any Microsemi product and to test and verify the same. The information contained herein is provided "AS IS, WHERE IS" and with all faults, and the entire risk associated with such information is entirely with the User. Microsemi specifically disclaims any liability of any kind including for consequential, incidental and punitive damages as well as lost profit. The product is subject to other terms and conditions which can be located on the web at <http://www.microsemi.com/legal/tnc.asp>

Life Support Application

Seller's Products are not designed, intended, or authorized for use as components in systems intended for space, aviation, surgical implant into the body, in other applications intended to support or sustain life, or for any other application in which the failure of the Seller's Product could create a situation where personal injury, death or property damage or loss may occur (collectively "Life Support Applications").

Buyer agrees not to use Products in any Life Support Applications and to the extent it does it shall conduct extensive testing of the Product in such applications and further agrees to indemnify and hold Seller, and its officers, employees, subsidiaries, affiliates, agents, sales representatives and distributors harmless against all claims, costs, damages and expenses, and attorneys' fees and costs arising, directly or indirectly, out of any claims of personal injury, death, damage or otherwise associated with the use of the goods in Life Support Applications, even if such claim includes allegations that Seller was negligent regarding the design or manufacture of the goods.

Buyer must notify Seller in writing before using Seller's Products in Life Support Applications. Seller will study with Buyer alternative solutions to meet Buyer application specification based on Sellers sales conditions applicable for the new proposed specific part.