



Chipsmall Limited consists of a professional team with an average of over 10 year of expertise in the distribution of electronic components. Based in Hongkong, we have already established firm and mutual-benefit business relationships with customers from,Europe,America and south Asia,supplying obsolete and hard-to-find components to meet their specific needs.

With the principle of “Quality Parts,Customers Priority,Honest Operation,and Considerate Service”,our business mainly focus on the distribution of electronic components. Line cards we deal with include Microchip,ALPS,ROHM,Xilinx,Pulse,ON,Everlight and Freescale. Main products comprise IC,Modules,Potentiometer,IC Socket,Relay,Connector.Our parts cover such applications as commercial,industrial, and automotives areas.

We are looking forward to setting up business relationship with you and hope to provide you with the best service and solution. Let us make a better world for our industry!



Contact us

Tel: +86-755-8981 8866 Fax: +86-755-8427 6832

Email & Skype: info@chipsmall.com Web: www.chipsmall.com

Address: A1208, Overseas Decoration Building, #122 Zhenhua RD., Futian, Shenzhen, China



Buck chopper
NPT IGBT Power Module

$V_{CES} = 600V$
 $I_C = 350A @ T_c = 80^\circ C$

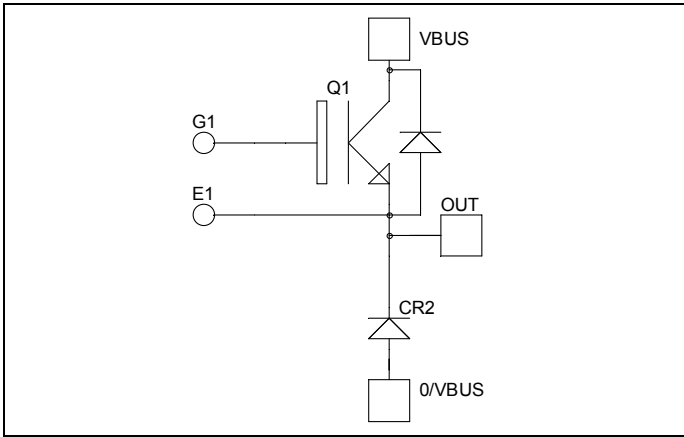

Application

- AC and DC motor control
- Switched Mode Power Supplies

Features

- Non Punch Through (NPT) Fast IGBT
 - Low voltage drop
 - Low tail current
 - Switching frequency up to 100 kHz
 - Soft recovery parallel diodes
 - Low diode VF
 - Low leakage current
 - RBSOA and SCSOA rated
- Kelvin emitter for easy drive
- Very low stray inductance
 - Symmetrical design
 - M5 power connectors
- High level of integration

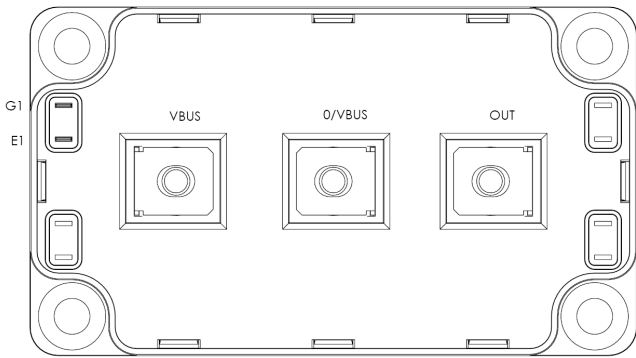

Benefits

- Outstanding performance at high frequency operation
- Stable temperature behavior
- Very rugged
- Direct mounting to heatsink (isolated package)
- Low junction to case thermal resistance
- Easy paralleling due to positive TC of VCEsat
- Low profile
- RoHS compliant

Absolute maximum ratings

Symbol	Parameter	Max ratings	Unit
V_{CES}	Collector - Emitter Breakdown Voltage	600	V
I_C	Continuous Collector Current	$T_c = 25^\circ C$	430
		$T_c = 80^\circ C$	350
I_{CM}	Pulsed Collector Current	$T_c = 25^\circ C$	1225
V_{GE}	Gate - Emitter Voltage	± 20	V
P_D	Maximum Power Dissipation	$T_c = 25^\circ C$	1562
RBSOA	Reverse Bias Safe Operating Area	$T_j = 150^\circ C$	800A @ 600V

CAUTION: These Devices are sensitive to Electrostatic Discharge. Proper Handling Procedures Should Be Followed. See application note APT0502 on www.microsemi.com

All ratings @ $T_j = 25^\circ\text{C}$ unless otherwise specified

Electrical Characteristics

Symbol	Characteristic	Test Conditions	Min	Typ	Max	Unit
I_{CES}	Zero Gate Voltage Collector Current	$V_{GE} = 0\text{V}$ $V_{CE} = 600\text{V}$	$T_j = 25^\circ\text{C}$		200	μA
			$T_j = 125^\circ\text{C}$		1750	
$V_{CE(sat)}$	Collector Emitter saturation Voltage	$V_{GE} = 15\text{V}$ $I_C = 360\text{A}$	$T_j = 25^\circ\text{C}$	2.0	2.5	V
			$T_j = 125^\circ\text{C}$	2.2		
$V_{GE(th)}$	Gate Threshold Voltage	$V_{GE} = V_{CE}, I_C = 4\text{mA}$	3		5	V
I_{GES}	Gate – Emitter Leakage Current	$V_{GE} = \pm 20\text{V}, V_{CE} = 0\text{V}$			± 300	nA

Dynamic Characteristics

Symbol	Characteristic	Test Conditions	Min	Typ	Max	Unit
C_{ies}	Input Capacitance	$V_{GE} = 0\text{V}$ $V_{CE} = 25\text{V}$ $f = 1\text{MHz}$		17.2		nF
C_{oes}	Output Capacitance			1.88		
C_{res}	Reverse Transfer Capacitance			1.6		
Q_g	Total gate Charge	$V_{GE} = 15\text{V}$ $V_{Bus} = 300\text{V}$ $I_C = 360\text{A}$		1320		nC
Q_{ge}	Gate – Emitter Charge			1160		
Q_{gc}	Gate – Collector Charge			800		
$T_{d(on)}$	Turn-on Delay Time	Inductive Switching (25°C) $V_{GE} = 15\text{V}$ $V_{Bus} = 400\text{V}$ $I_C = 360\text{A}$ $R_G = 1.25\Omega$		26		ns
T_r	Rise Time			25		
$T_{d(off)}$	Turn-off Delay Time			150		
T_f	Fall Time			30		
$T_{d(on)}$	Turn-on Delay Time	Inductive Switching (125°C) $V_{GE} = 15\text{V}$ $V_{Bus} = 400\text{V}$ $I_C = 360\text{A}$ $R_G = 1.25\Omega$		26		ns
T_r	Rise Time			25		
$T_{d(off)}$	Turn-off Delay Time			170		
T_f	Fall Time			40		
E_{on}	Turn-on Switching Energy	$V_{GE} = 15\text{V}$ $V_{Bus} = 400\text{V}$ $I_C = 360\text{A}$	$T_j = 125^\circ\text{C}$	17.2		mJ
E_{off}	Turn-off Switching Energy	$R_G = 1.25\Omega$	$T_j = 125^\circ\text{C}$	14		

Chopper diode ratings and characteristics

Symbol	Characteristic	Test Conditions	Min	Typ	Max	Unit
V_{RRM}	Maximum Peak Repetitive Reverse Voltage		600			V
I_{RM}	Maximum Reverse Leakage Current	$V_R = 600\text{V}$	$T_j = 25^\circ\text{C}$		750	μA
			$T_j = 125^\circ\text{C}$		1500	
I_F	DC Forward Current			400		A
V_F	Diode Forward Voltage	$I_F = 400\text{A}$		1.6	1.8	V
		$I_F = 800\text{A}$		1.9		
		$I_F = 400\text{A}$	$T_j = 125^\circ\text{C}$	1.4		
t_{rr}	Reverse Recovery Time	$I_F = 400\text{A}$ $V_R = 400\text{V}$ $di/dt = 800\text{A}/\mu\text{s}$	$T_j = 25^\circ\text{C}$	180		ns
			$T_j = 125^\circ\text{C}$	220		
Q_{rr}	Reverse Recovery Charge	$I_F = 400\text{A}$ $V_R = 400\text{V}$ $di/dt = 800\text{A}/\mu\text{s}$	$T_j = 25^\circ\text{C}$	1560		nC
			$T_j = 125^\circ\text{C}$	5800		

Thermal and package characteristics

Symbol	Characteristic	Min	Typ	Max	Unit	
R _{thJC}	Junction to Case Thermal Resistance	IGBT		0.08	°C/W	
		Diode		0.16		
V _{ISOL}	RMS Isolation Voltage, any terminal to case t=1 min, 50/60Hz	4000			V	
T _J	Operating junction temperature range	-40		150	°C	
T _{STG}	Storage Temperature Range	-40		125		
T _C	Operating Case Temperature	-40		100		
Torque	Mounting torque	To heatsink	M6	3	5	N.m
		For terminals	M5	2	3.5	
Wt	Package Weight			300	g	

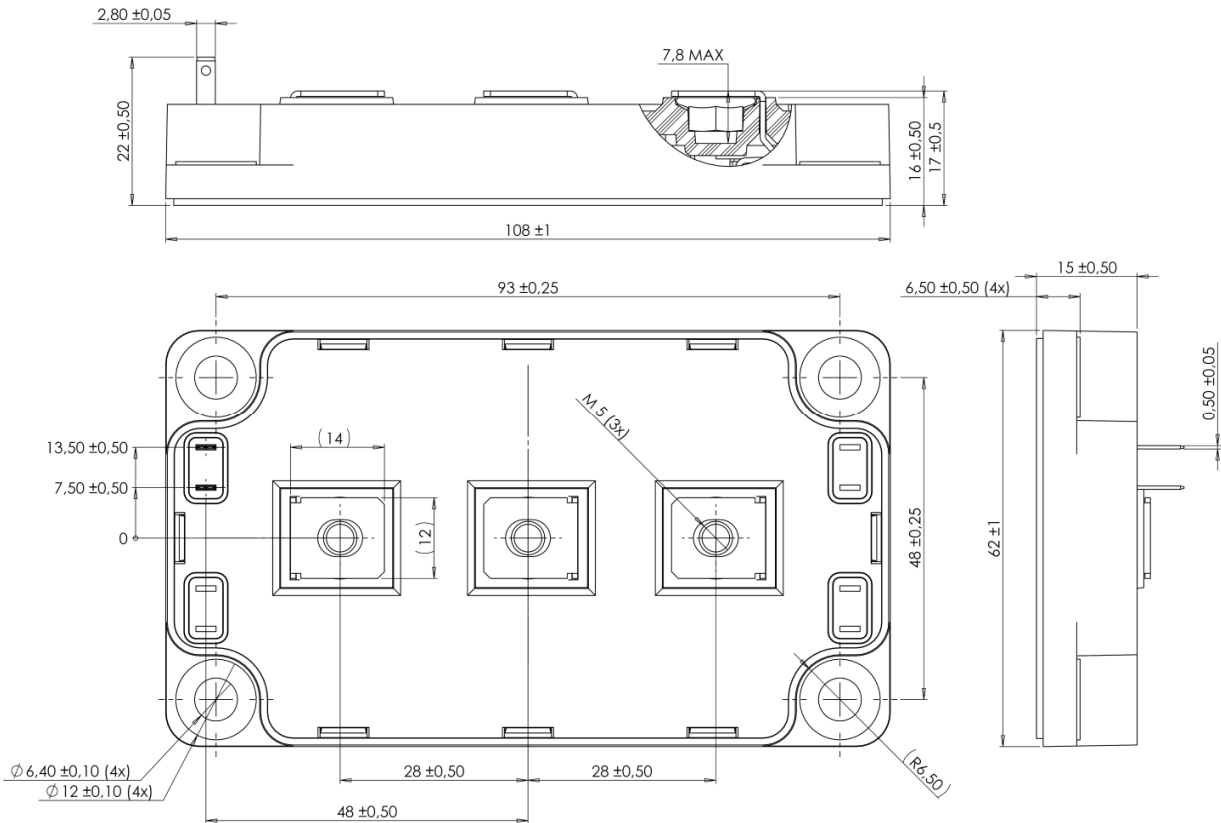
SP6 Package outline (dimensions in mm)

See application note APT0601 - Mounting Instructions for SP6 Power Modules on www.microsemi.com

Typical Performance Curve

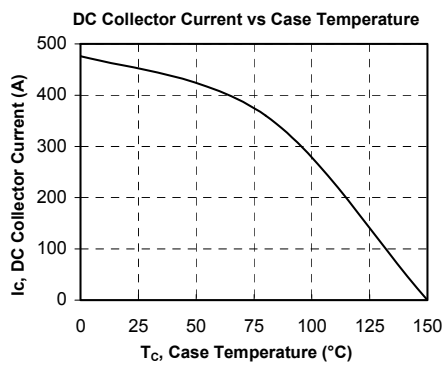
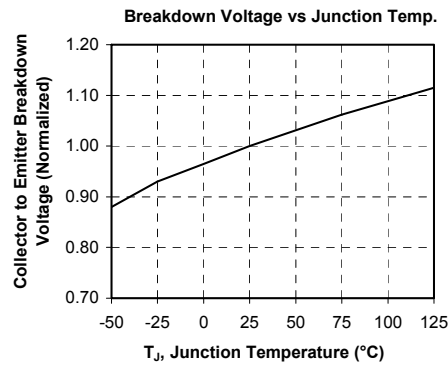
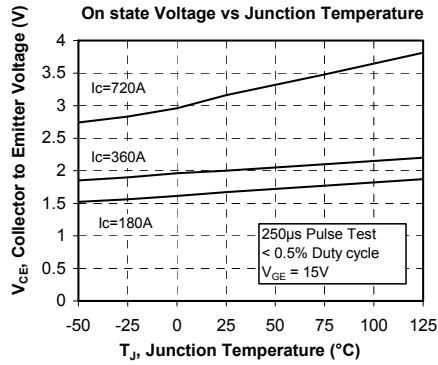
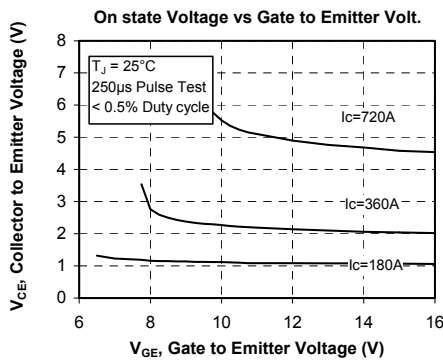
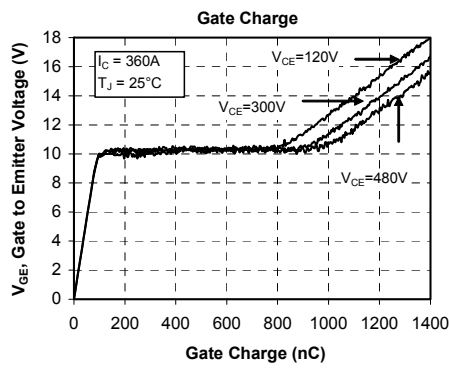
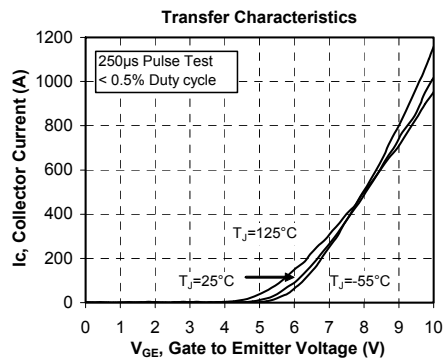
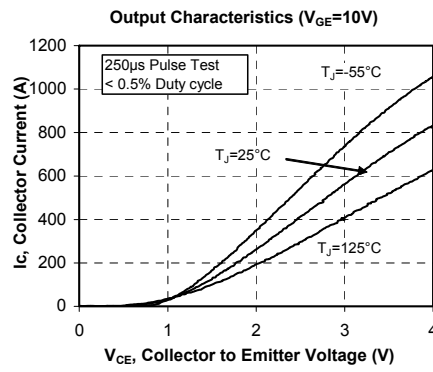
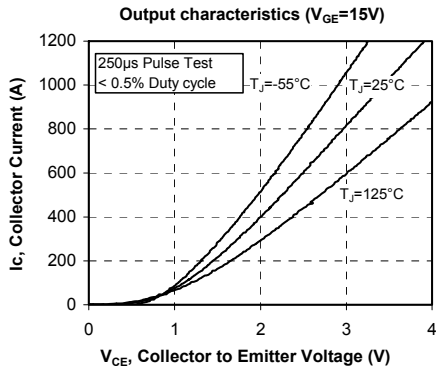

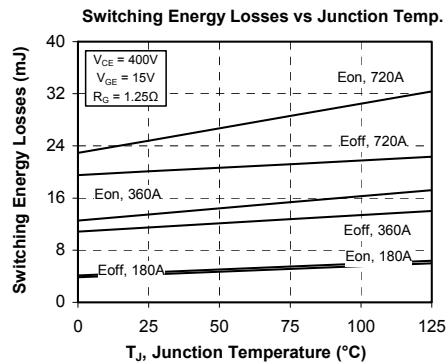
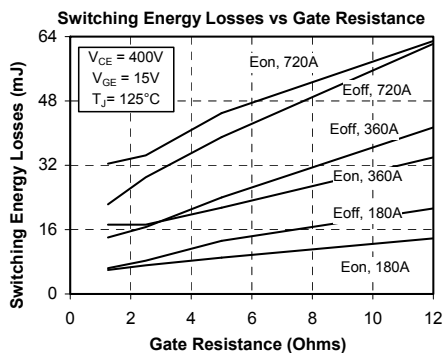
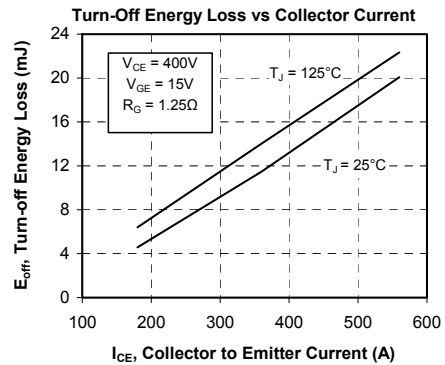
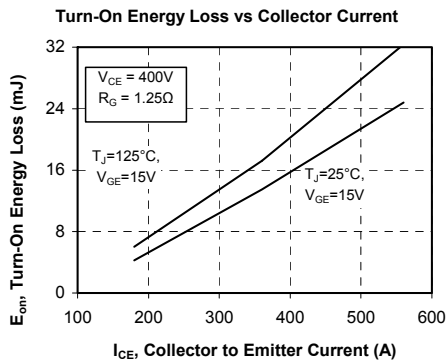
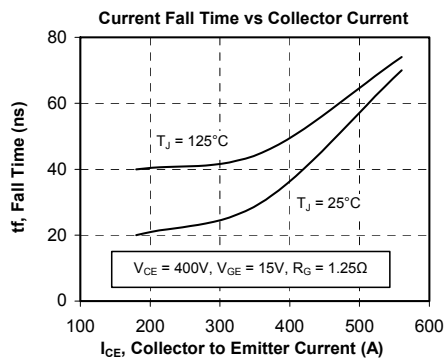
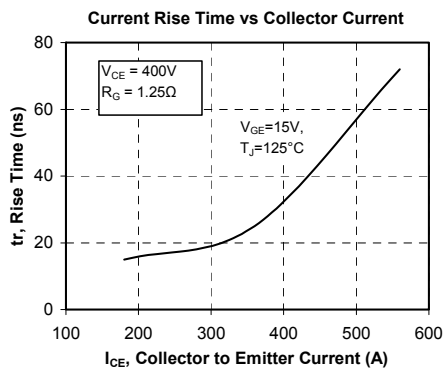
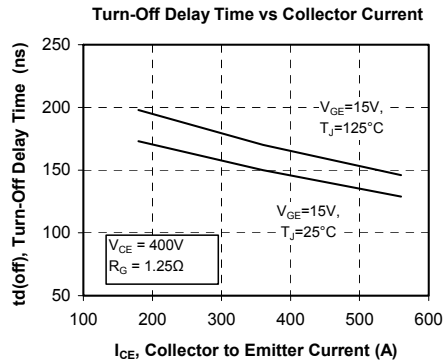
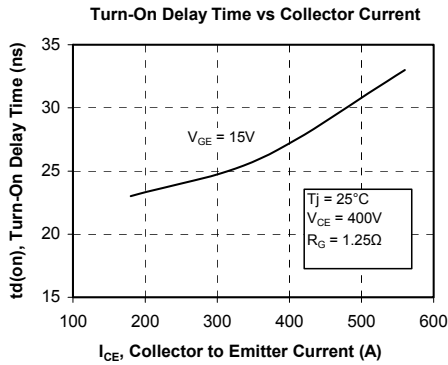

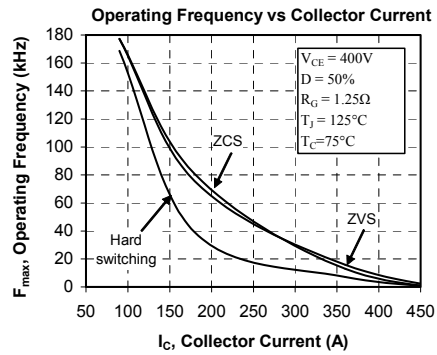
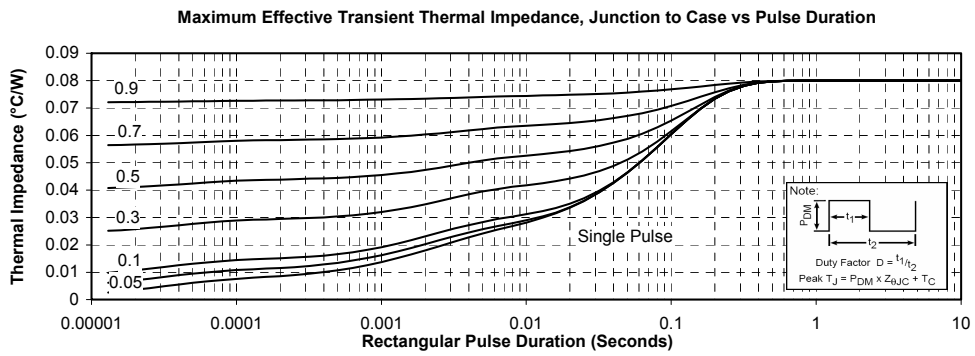
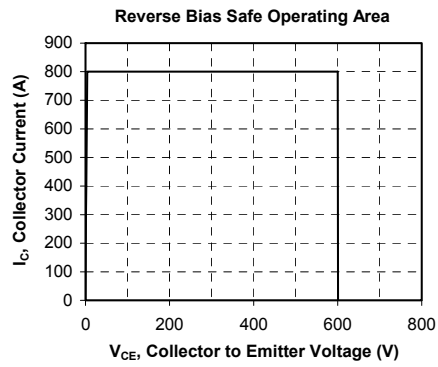
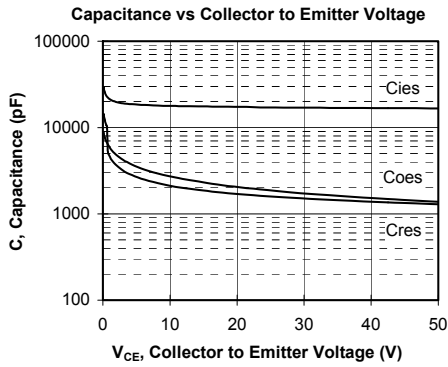

DISCLAIMER

The information contained in the document (unless it is publicly available on the Web without access restrictions) is PROPRIETARY AND CONFIDENTIAL information of Microsemi and cannot be copied, published, uploaded, posted, transmitted, distributed or disclosed or used without the express duly signed written consent of Microsemi. If the recipient of this document has entered into a disclosure agreement with Microsemi, then the terms of such Agreement will also apply. This document and the information contained herein may not be modified, by any person other than authorized personnel of Microsemi. No license under any patent, copyright, trade secret or other intellectual property right is granted to or conferred upon you by disclosure or delivery of the information, either expressly, by implication, inducement, estoppels or otherwise. Any license under such intellectual property rights must be approved by Microsemi in writing signed by an officer of Microsemi.

Microsemi reserves the right to change the configuration, functionality and performance of its products at anytime without any notice. This product has been subject to limited testing and should not be used in conjunction with life-support or other mission-critical equipment or applications. Microsemi assumes no liability whatsoever, and Microsemi disclaims any express or implied warranty, relating to sale and/or use of Microsemi products including liability or warranties relating to fitness for a particular purpose, merchantability, or infringement of any patent, copyright or other intellectual property right. Any performance specifications believed to be reliable but are not verified and customer or user must conduct and complete all performance and other testing of this product as well as any user or customers final application. User or customer shall not rely on any data and performance specifications or parameters provided by Microsemi. It is the customer's and user's responsibility to independently determine suitability of any Microsemi product and to test and verify the same. The information contained herein is provided "AS IS, WHERE IS" and with all faults, and the entire risk associated with such information is entirely with the User. Microsemi specifically disclaims any liability of any kind including for consequential, incidental and punitive damages as well as lost profit. The product is subject to other terms and conditions which can be located on the web at <http://www.microsemi.com/legal/tnc.asp>

Life Support Application

Seller's Products are not designed, intended, or authorized for use as components in systems intended for space, aviation, surgical implant into the body, in other applications intended to support or sustain life, or for any other application in which the failure of the Seller's Product could create a situation where personal injury, death or property damage or loss may occur (collectively "Life Support Applications").

Buyer agrees not to use Products in any Life Support Applications and to the extent it does it shall conduct extensive testing of the Product in such applications and further agrees to indemnify and hold Seller, and its officers, employees, subsidiaries, affiliates, agents, sales representatives and distributors harmless against all claims, costs, damages and expenses, and attorneys' fees and costs arising, directly or indirectly, out of any claims of personal injury, death, damage or otherwise associated with the use of the goods in Life Support Applications, even if such claim includes allegations that Seller was negligent regarding the design or manufacture of the goods.

Buyer must notify Seller in writing before using Seller's Products in Life Support Applications. Seller will study with Buyer alternative solutions to meet Buyer application specification based on Sellers sales conditions applicable for the new proposed specific part.