



Chipsmall Limited consists of a professional team with an average of over 10 year of expertise in the distribution of electronic components. Based in Hongkong, we have already established firm and mutual-benefit business relationships with customers from,Europe,America and south Asia,supplying obsolete and hard-to-find components to meet their specific needs.

With the principle of “Quality Parts,Customers Priority,Honest Operation,and Considerate Service”,our business mainly focus on the distribution of electronic components. Line cards we deal with include Microchip,ALPS,ROHM,Xilinx,Pulse,ON,Everlight and Freescale. Main products comprise IC,Modules,Potentiometer,IC Socket,Relay,Connector.Our parts cover such applications as commercial,industrial, and automotives areas.

We are looking forward to setting up business relationship with you and hope to provide you with the best service and solution. Let us make a better world for our industry!



## Contact us

Tel: +86-755-8981 8866 Fax: +86-755-8427 6832

Email & Skype: info@chipsmall.com Web: www.chipsmall.com

Address: A1208, Overseas Decoration Building, #122 Zhenhua RD., Futian, Shenzhen, China



## Phase leg NPT IGBT Power Module

$V_{CES} = 600V$   
 $I_C = 90A @ T_c = 80^\circ C$

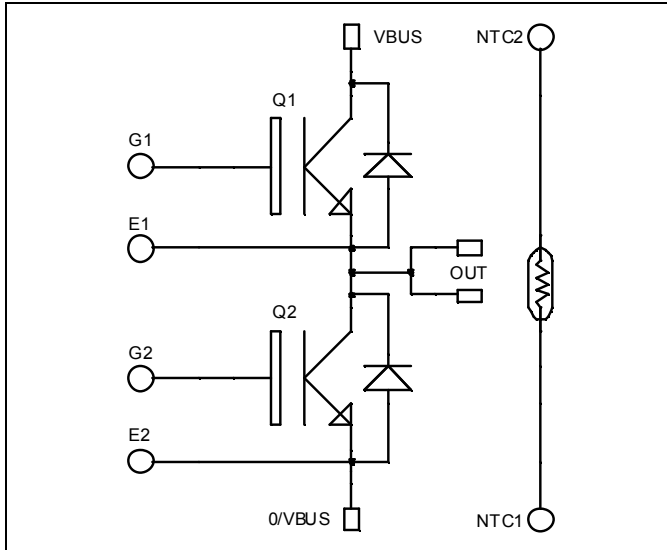

### Application

- Welding converters
- Switched Mode Power Supplies
- Uninterruptible Power Supplies
- Motor control

### Features

- Non Punch Through (NPT) Fast IGBT®
  - Low voltage drop
  - Low tail current
  - Switching frequency up to 100 kHz
  - Soft recovery parallel diodes
  - Low diode VF
  - Low leakage current
  - Avalanche energy rated
  - RBSOA and SCSOA rated
- Kelvin emitter for easy drive
- Very low stray inductance
  - Symmetrical design
  - Lead frames for power connections
- Internal thermistor for temperature monitoring
- High level of integration

### Benefits

- Outstanding performance at high frequency operation
- Stable temperature behavior
- Very rugged
- Direct mounting to heatsink (isolated package)
- Low junction to case thermal resistance
- Solderable terminals both for power and signal for easy PCB mounting
- Easy paralleling due to positive TC of VCEsat
- Low profile
- RoHS compliant

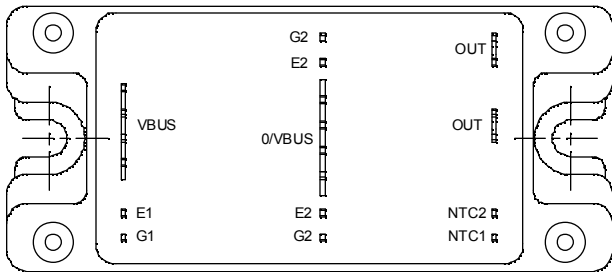

### Absolute maximum ratings

Symbol	Parameter	Max ratings	Unit
$V_{CES}$	Collector - Emitter Breakdown Voltage	600	V
$I_C$	Continuous Collector Current	$T_c = 25^\circ C$	110
		$T_c = 80^\circ C$	90
$I_{CM}$	Pulsed Collector Current	$T_c = 25^\circ C$	315
$V_{GE}$	Gate - Emitter Voltage	$\pm 20$	V
$P_D$	Maximum Power Dissipation	$T_c = 25^\circ C$	416
RBSOA	Reverse Bias Safe Operating Area	$T_j = 150^\circ C$	200A @ 600V

**CAUTION:** These Devices are sensitive to Electrostatic Discharge. Proper Handling Procedures Should Be Followed. See application note APT0502 on [www.microsemi.com](http://www.microsemi.com)

All ratings @  $T_j = 25^\circ\text{C}$  unless otherwise specified

**Electrical Characteristics**

Symbol	Characteristic	Test Conditions	Min	Typ	Max	Unit
$I_{CES}$	Zero Gate Voltage Collector Current	$V_{GE} = 0\text{V}$ $V_{CE} = 600\text{V}$			250 500	$\mu\text{A}$
$V_{CE(sat)}$	Collector Emitter saturation Voltage	$V_{GE} = 15\text{V}$ $I_C = 90\text{A}$		2.0 2.2	2.5	V
$V_{GE(th)}$	Gate Threshold Voltage	$V_{GE} = V_{CE}, I_C = 1\text{mA}$	3		5	V
$I_{GES}$	Gate – Emitter Leakage Current	$V_{GE} = 20\text{V}, V_{CE} = 0\text{V}$			$\pm 150$	nA

**Dynamic Characteristics**

Symbol	Characteristic	Test Conditions	Min	Typ	Max	Unit
$C_{ies}$	Input Capacitance	$V_{GE} = 0\text{V}$		4300		pF
$C_{oes}$	Output Capacitance	$V_{CE} = 25\text{V}$		470		
$C_{res}$	Reverse Transfer Capacitance	$f = 1\text{MHz}$		400		
$Q_g$	Total gate Charge	$V_{GE} = 15\text{V}$		330		nC
$Q_{ge}$	Gate – Emitter Charge	$V_{Bus} = 300\text{V}$		290		
$Q_{gc}$	Gate – Collector Charge	$I_C = 90\text{A}$		200		
$T_{d(on)}$	Turn-on Delay Time	Inductive Switching ( $25^\circ\text{C}$ )		26		ns
$T_r$	Rise Time	$V_{GE} = 15\text{V}$		25		
$T_{d(off)}$	Turn-off Delay Time	$V_{Bus} = 400\text{V}$		150		
$T_f$	Fall Time	$I_C = 90\text{A}$ $R_G = 5\ \Omega$		30		
$T_{d(on)}$	Turn-on Delay Time	Inductive Switching ( $125^\circ\text{C}$ )		26		ns
$T_r$	Rise Time	$V_{GE} = 15\text{V}$		25		
$T_{d(off)}$	Turn-off Delay Time	$V_{Bus} = 400\text{V}$		170		
$T_f$	Fall Time	$I_C = 90\text{A}$ $R_G = 5\ \Omega$		40		
$E_{on}$	Turn-on Switching Energy	$V_{GE} = 15\text{V}$ $V_{Bus} = 400\text{V}$		4.3		mJ
$E_{off}$	Turn-off Switching Energy	$I_C = 90\text{A}$ $R_G = 5\ \Omega$		3.5		

**Reverse diode ratings and characteristics**

Symbol	Characteristic	Test Conditions	Min	Typ	Max	Unit
$V_{RRM}$	Maximum Peak Repetitive Reverse Voltage		600			V
$I_{RM}$	Maximum Reverse Leakage Current	$V_R = 600\text{V}$			350 600	$\mu\text{A}$
$I_F$	DC Forward Current			60		A
$V_F$	Diode Forward Voltage	$I_F = 60\text{A}$		1.6	1.8	V
		$I_F = 120\text{A}$		1.9		
		$I_F = 60\text{A}$ $T_j = 125^\circ\text{C}$		1.4		
$t_{rr}$	Reverse Recovery Time	$I_F = 60\text{A}$		85		ns
		$V_R = 400\text{V}$		160		
$Q_{rr}$	Reverse Recovery Charge	$di/dt = 400\text{A}/\mu\text{s}$		260		nC
				1400		



## Thermal and package characteristics

**Symbol Characteristic**

			<i>Min</i>	<i>Typ</i>	<i>Max</i>	<i>Unit</i>
R <sub>thJC</sub>	Junction to Case Thermal Resistance	IGBT			0.3	°C/W
		Diode			0.65	
V <sub>ISOL</sub>	RMS Isolation Voltage, any terminal to case t=1 min, I <sub>isol</sub> <1mA, 50/60Hz		2500			V
T <sub>J</sub>	Operating junction temperature range		-40		150	°C
T <sub>STG</sub>	Storage Temperature Range		-40		125	
T <sub>C</sub>	Operating Case Temperature		-40		100	
Torque	Mounting torque	To Heatsink	M5	2.5	4.7	N.m
Wt	Package Weight				160	g

## Temperature sensor NTC (see application note APT0406 on www.microsemi.com for more information).

**Symbol Characteristic**

		<i>Min</i>	<i>Typ</i>	<i>Max</i>	<i>Unit</i>
R <sub>25</sub>	Resistance @ 25°C		50		kΩ
B <sub>25/85</sub>	T <sub>25</sub> = 298.15 K		3952		K

$$R_T = \frac{R_{25}}{\exp \left[ B_{25/85} \left( \frac{1}{T} - \frac{1}{T_{25}} \right) \right]}$$

T: Thermistor temperature  
 R<sub>T</sub>: Thermistor value at T

## SP4 Package outline (dimensions in mm)

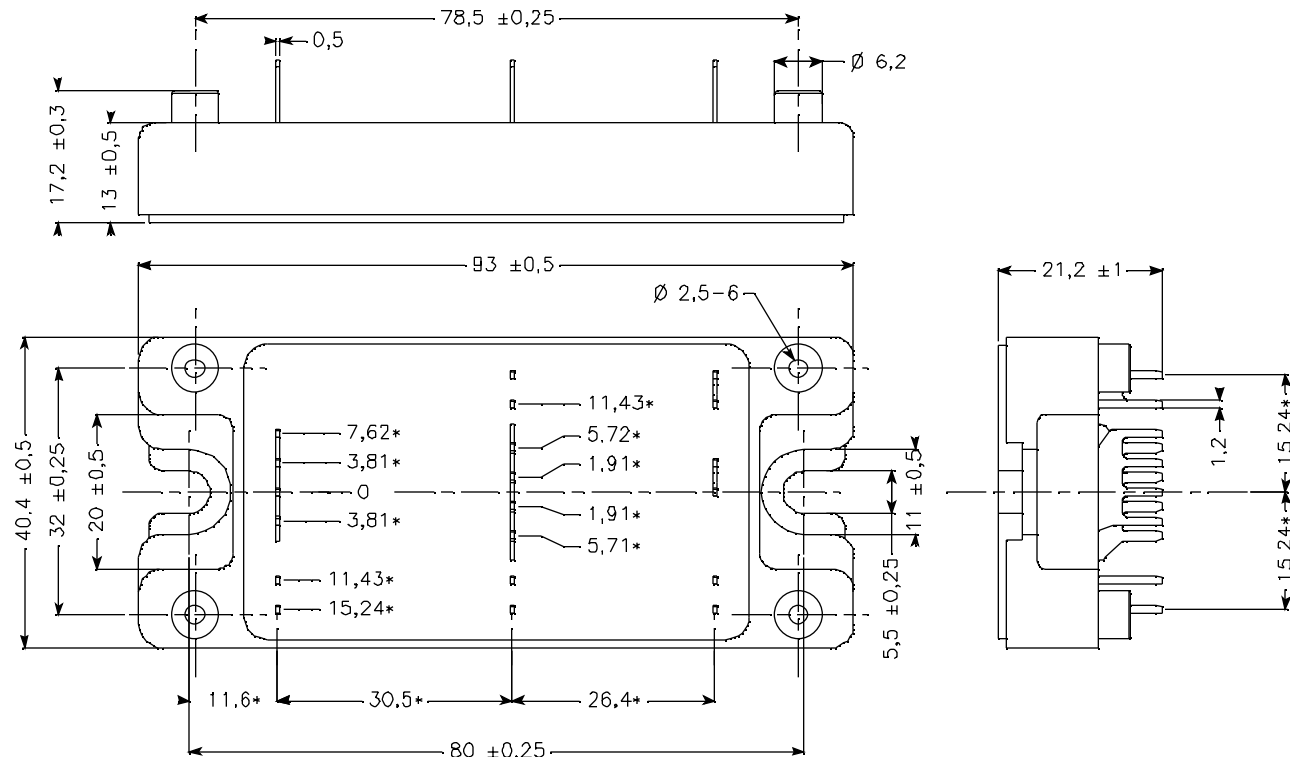

ALL DIMENSIONS MARKED "\*" ARE TOLERENCED AS:  $\oplus \ominus \emptyset 1$

See application note APT0501 - Mounting Instructions for SP4 Power Modules on [www.microsemi.com](http://www.microsemi.com)

## Typical Performance Curve

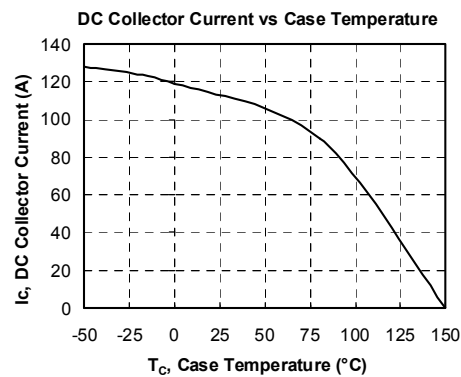
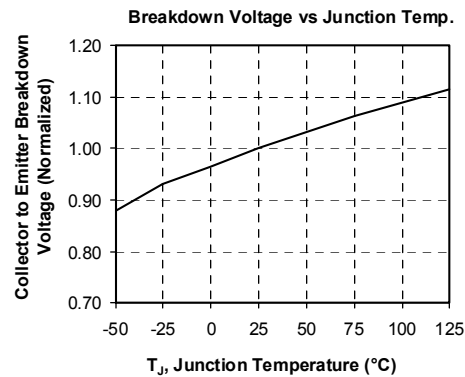
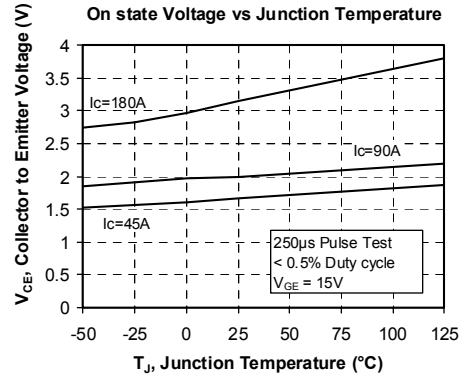
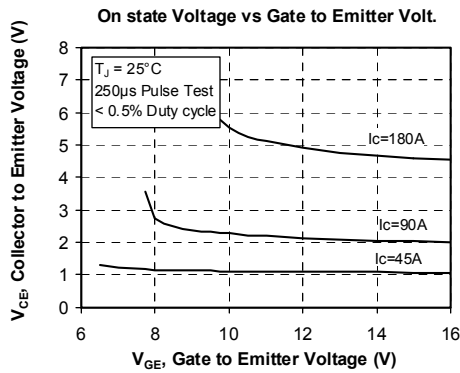
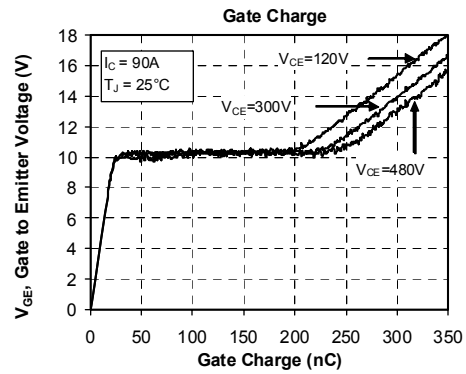
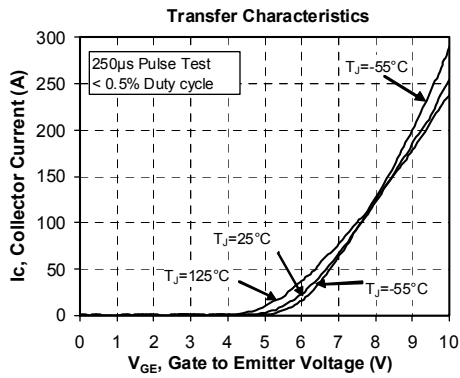
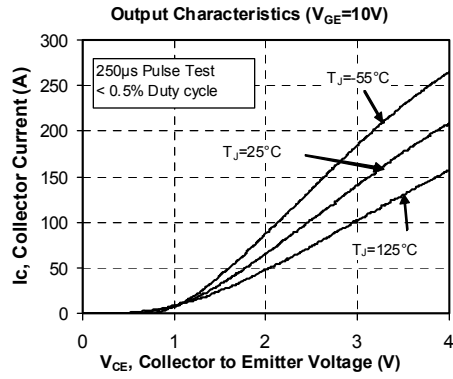
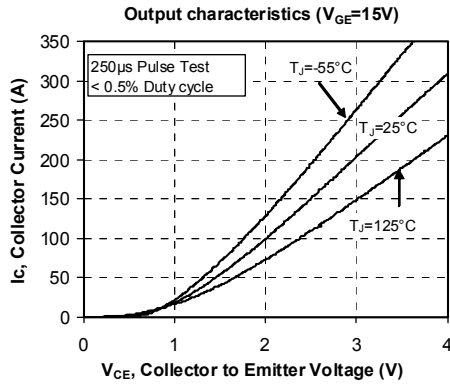

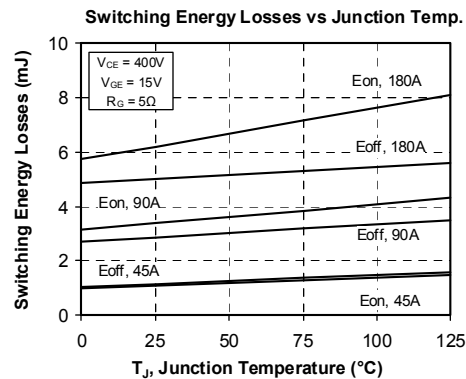
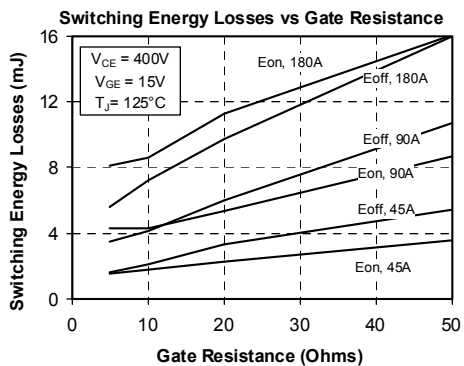
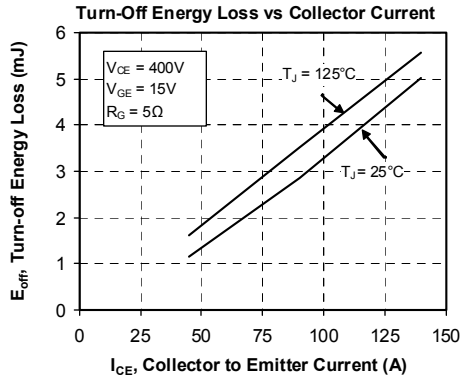
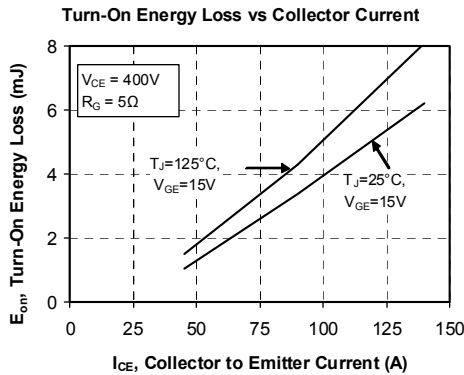
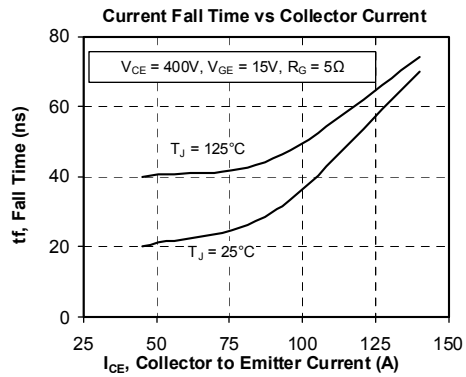
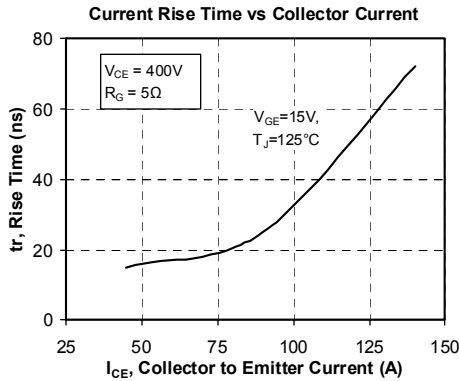
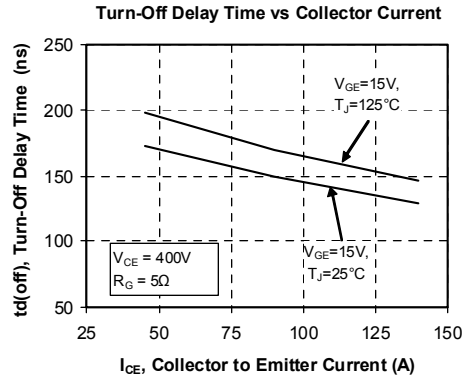
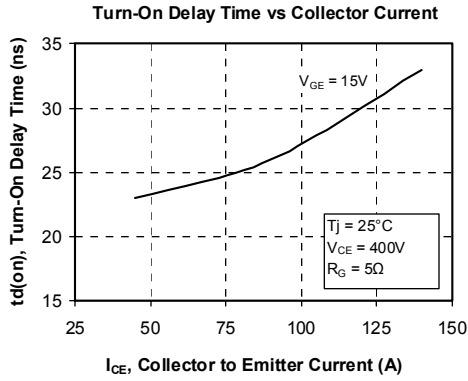

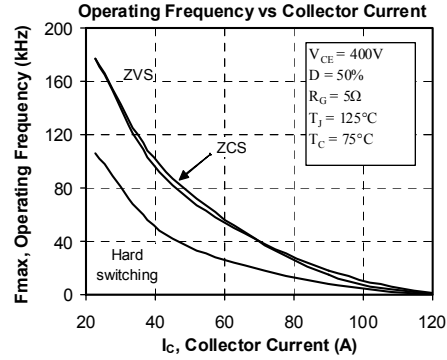
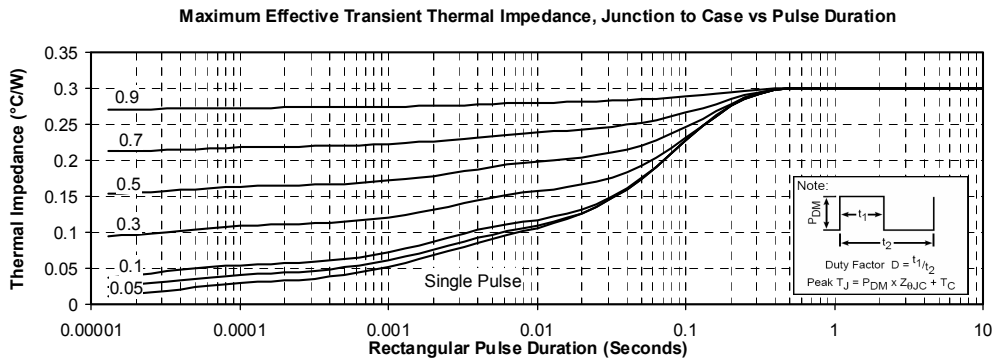
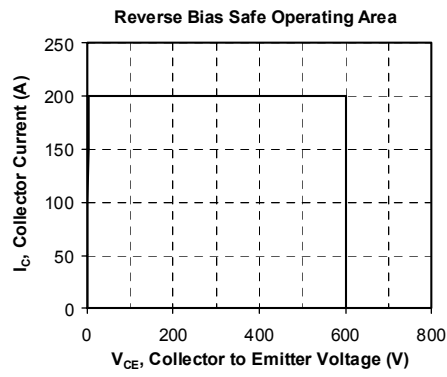
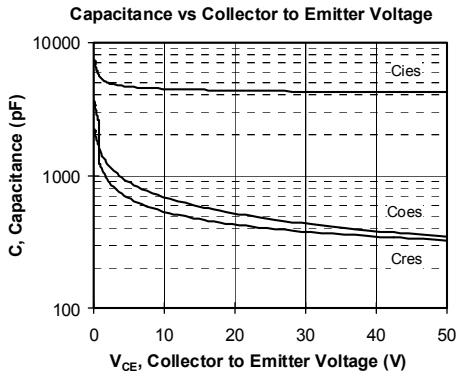

Microsemi reserves the right to change, without notice, the specifications and information contained herein

Microsemi's products are covered by one or more of U.S. patents 4,895,810 5,045,903 5,089,434 5,182,234 5,019,522 5,262,336 6,503,786 5,256,583 4,748,103 5,283,202 5,231,474 5,434,095 5,528,058 and foreign patents. U.S. and Foreign patents pending. All Rights Reserved.