



Chipsmall Limited consists of a professional team with an average of over 10 year of expertise in the distribution of electronic components. Based in Hongkong, we have already established firm and mutual-benefit business relationships with customers from,Europe,America and south Asia,supplying obsolete and hard-to-find components to meet their specific needs.

With the principle of “Quality Parts,Customers Priority,Honest Operation,and Considerate Service”,our business mainly focus on the distribution of electronic components. Line cards we deal with include Microchip,ALPS,ROHM,Xilinx,Pulse,ON,Everlight and Freescale. Main products comprise IC,Modules,Potentiometer,IC Socket,Relay,Connector.Our parts cover such applications as commercial,industrial, and automotives areas.

We are looking forward to setting up business relationship with you and hope to provide you with the best service and solution. Let us make a better world for our industry!



Contact us

Tel: +86-755-8981 8866 Fax: +86-755-8427 6832

Email & Skype: info@chipsmall.com Web: www.chipsmall.com

Address: A1208, Overseas Decoration Building, #122 Zhenhua RD., Futian, Shenzhen, China



Full - Bridge MOSFET Power Module

$V_{DSS} = 1200V$
 $R_{DSon} = 570m\Omega$ typ @ $T_j = 25^\circ C$
 $I_D = 17A$ @ $T_c = 25^\circ C$

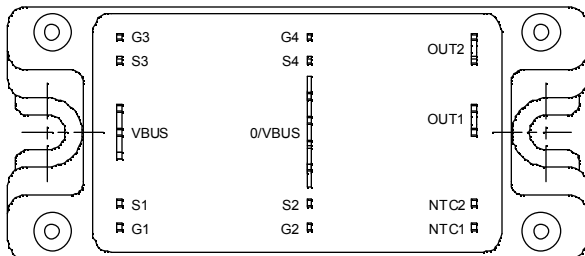
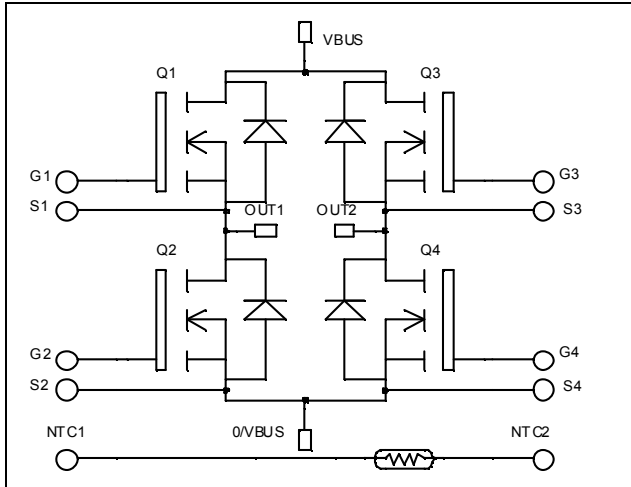

Application

- Welding converters
- Switched Mode Power Supplies
- Uninterruptible Power Supplies
- Motor control

Features

- Power MOS 7[®] FREDFETs
 - Low R_{DSon}
 - Low input and Miller capacitance
 - Low gate charge
 - Fast intrinsic reverse diode
 - Avalanche energy rated
 - Very rugged
- Kelvin source for easy drive
- Very low stray inductance
 - Symmetrical design
 - Lead frames for power connections
- Internal thermistor for temperature monitoring
- High level of integration

Benefits

- Outstanding performance at high frequency operation
- Direct mounting to heatsink (isolated package)
- Low junction to case thermal resistance
- Solderable terminals both for power and signal for easy PCB mounting
- Low profile
- RoHS Compliant

Absolute maximum ratings

Symbol	Parameter	Max ratings	Unit
V_{DSS}	Drain - Source Breakdown Voltage	1200	V
I_D	Continuous Drain Current	$T_c = 25^\circ C$	17
		$T_c = 80^\circ C$	13
I_{DM}	Pulsed Drain current	68	A
V_{GS}	Gate - Source Voltage	± 30	V
R_{DSon}	Drain - Source ON Resistance	684	$m\Omega$
P_D	Maximum Power Dissipation	$T_c = 25^\circ C$	390
I_{AR}	Avalanche current (repetitive and non repetitive)	22	A
E_{AR}	Repetitive Avalanche Energy	50	mJ
E_{AS}	Single Pulse Avalanche Energy	3000	

CAUTION: These Devices are sensitive to Electrostatic Discharge. Proper Handling Procedures Should Be Followed. See application note APT0502 on www.microsemi.com

All ratings @ $T_j = 25^\circ\text{C}$ unless otherwise specified

Electrical Characteristics

Symbol	Characteristic	Test Conditions	Min	Typ	Max	Unit
I_{DSS}	Zero Gate Voltage Drain Current	$V_{GS} = 0\text{V}, V_{DS} = 1200\text{V}$			250	μA
		$V_{GS} = 0\text{V}, V_{DS} = 1000\text{V}$			1000	
$R_{DS(on)}$	Drain – Source on Resistance	$V_{GS} = 10\text{V}, I_D = 8.5\text{A}$		570	684	$\text{m}\Omega$
$V_{GS(th)}$	Gate Threshold Voltage	$V_{GS} = V_{DS}, I_D = 2.5\text{mA}$	3		5	V
I_{GSS}	Gate – Source Leakage Current	$V_{GS} = \pm 30\text{V}, V_{DS} = 0\text{V}$			± 100	nA

Dynamic Characteristics

Symbol	Characteristic	Test Conditions	Min	Typ	Max	Unit
C_{iss}	Input Capacitance	$V_{GS} = 0\text{V}$ $V_{DS} = 25\text{V}$ $f = 1\text{MHz}$		5155		pF
C_{oss}	Output Capacitance			770		
C_{rss}	Reverse Transfer Capacitance			130		
Q_g	Total gate Charge	$V_{GS} = 10\text{V}$ $V_{Bus} = 600\text{V}$ $I_D = 17\text{A}$		187		nC
Q_{gs}	Gate – Source Charge			24		
Q_{gd}	Gate – Drain Charge			120		
$T_{d(on)}$	Turn-on Delay Time	Inductive switching @ 125°C $V_{GS} = 15\text{V}$ $V_{Bus} = 800\text{V}$ $I_D = 17\text{A}$ $R_G = 5\Omega$		20		ns
T_r	Rise Time			15		
$T_{d(off)}$	Turn-off Delay Time			160		
T_f	Fall Time			45		
E_{on}	Turn-on Switching Energy	Inductive switching @ 25°C $V_{GS} = 15\text{V}, V_{Bus} = 800\text{V}$ $I_D = 17\text{A}, R_G = 5\Omega$		990		μJ
E_{off}	Turn-off Switching Energy			685		
E_{on}	Turn-on Switching Energy	Inductive switching @ 125°C $V_{GS} = 15\text{V}, V_{Bus} = 800\text{V}$ $I_D = 17\text{A}, R_G = 5\Omega$		1565		μJ
E_{off}	Turn-off Switching Energy			857		

Source - Drain diode ratings and characteristics

Symbol	Characteristic	Test Conditions	Min	Typ	Max	Unit
I_S	Continuous Source current (Body diode)		$T_c = 25^\circ\text{C}$		17	A
			$T_c = 80^\circ\text{C}$		13	
V_{SD}	Diode Forward Voltage	$V_{GS} = 0\text{V}, I_S = -17\text{A}$			1.3	V
dv/dt	Peak Diode Recovery ①				18	V/ns
t_{rr}	Reverse Recovery Time	$I_S = -17\text{A}$ $V_R = 600\text{V}$ $di_S/dt = 100\text{A}/\mu\text{s}$	$T_j = 25^\circ\text{C}$		320	ns
			$T_j = 125^\circ\text{C}$		650	
Q_{rr}	Reverse Recovery Charge	$I_S = -17\text{A}$ $V_R = 600\text{V}$ $di_S/dt = 100\text{A}/\mu\text{s}$	$T_j = 25^\circ\text{C}$	2		μC
			$T_j = 125^\circ\text{C}$	7		

 ① dv/dt numbers reflect the limitations of the circuit rather than the device itself.

$$I_S \leq -17\text{A} \quad di/dt \leq 700\text{A}/\mu\text{s} \quad V_R \leq V_{DSS} \quad T_j \leq 150^\circ\text{C}$$

Thermal and package characteristics

Symbol	Characteristic	Min	Typ	Max	Unit	
R _{thJC}	Junction to Case Thermal Resistance			0.32	°C/W	
V _{ISOL}	RMS Isolation Voltage, any terminal to case t=1 min, I _{isol} <1mA, 50/60Hz	2500			V	
T _J	Operating junction temperature range	-40		150	°C	
T _{STG}	Storage Temperature Range	-40		125		
T _C	Operating Case Temperature	-40		100		
Torque	Mounting torque	To Heatsink	M5	2.5	4.7	N.m
Wt	Package Weight			160		g

Temperature sensor NTC (see application note APT0406 on www.microsemi.com for more information).

Symbol	Characteristic	Min	Typ	Max	Unit
R ₂₅	Resistance @ 25°C		50		kΩ
B _{25/85}	T ₂₅ = 298.15 K		3952		K

$$R_T = \frac{R_{25}}{\exp\left[B_{25/85}\left(\frac{1}{T_{25}} - \frac{1}{T}\right)\right]}$$

T: Thermistor temperature
 R_T: Thermistor value at T

SP4 Package outline (dimensions in mm)

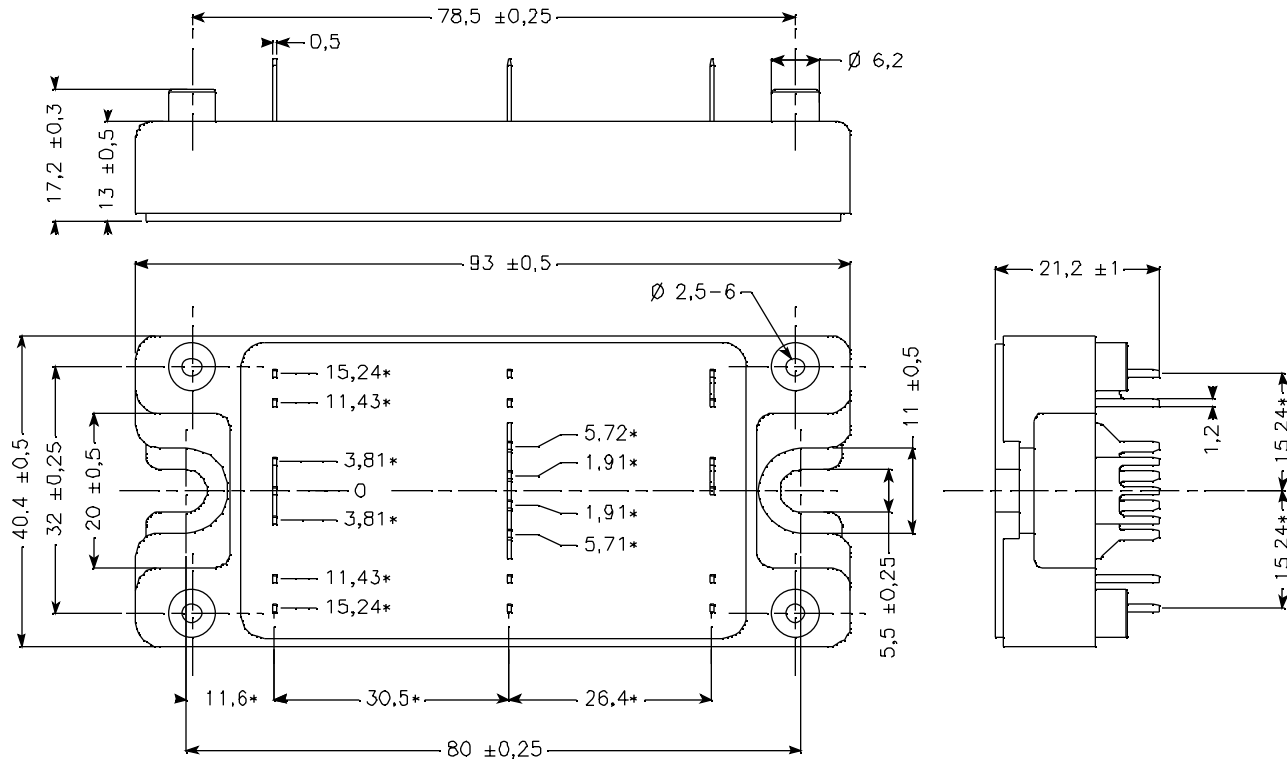

ALL DIMENSIONS MARKED "*" ARE TOLERANCED AS: $\oplus\ominus\ 0.1$

See application note APT0501 - Mounting Instructions for SP4 Power Modules on www.microsemi.com

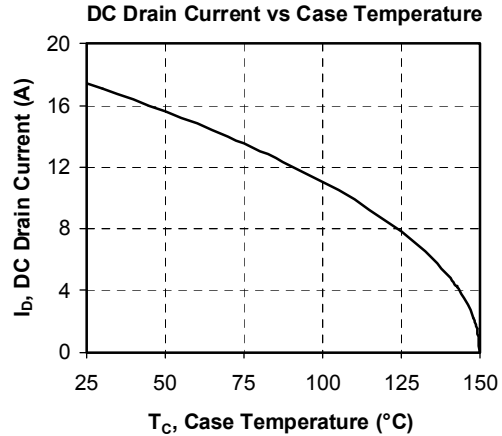
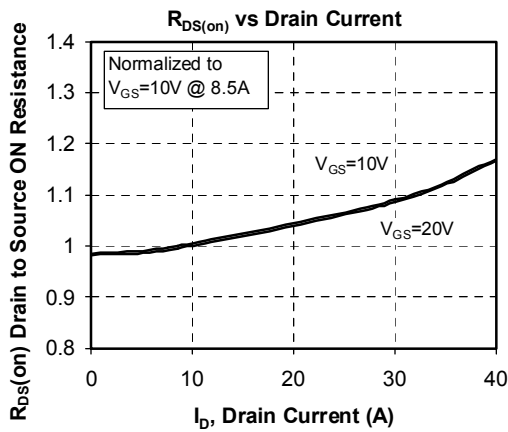
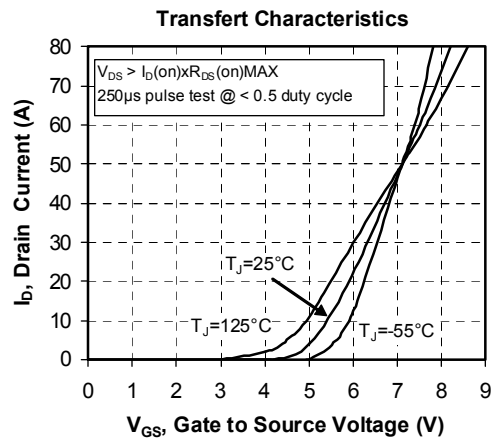
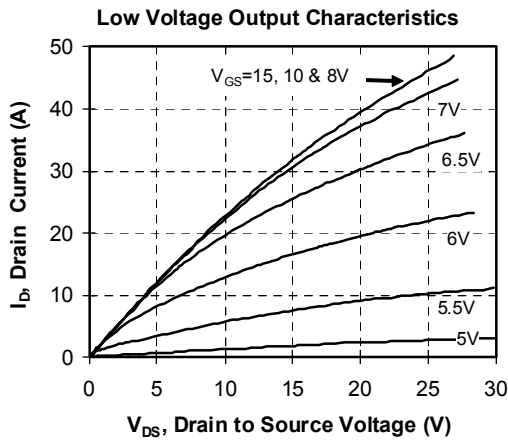
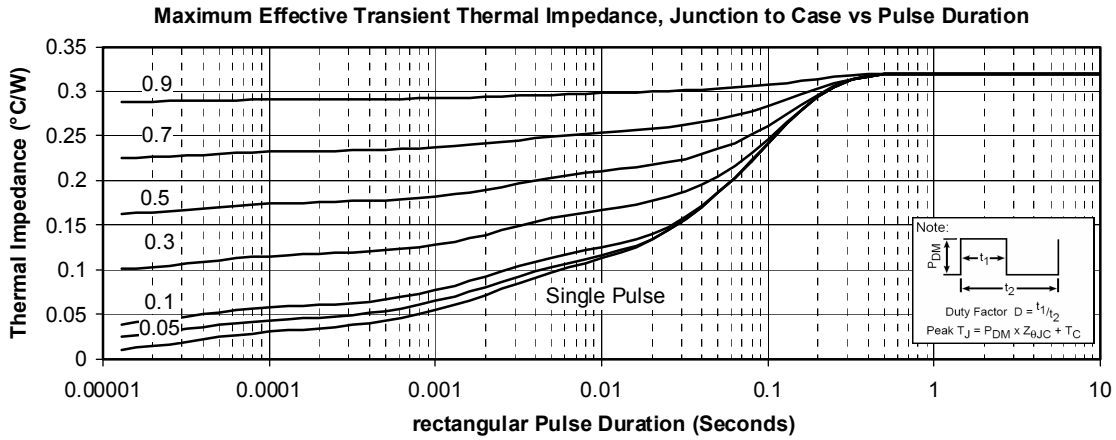
Typical Performance Curve

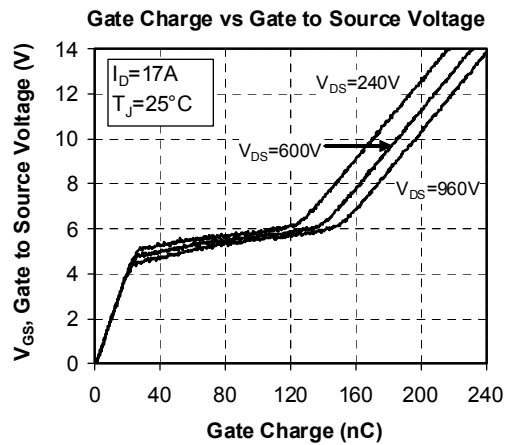
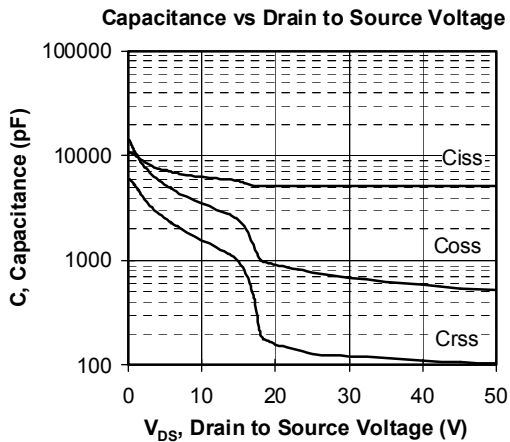
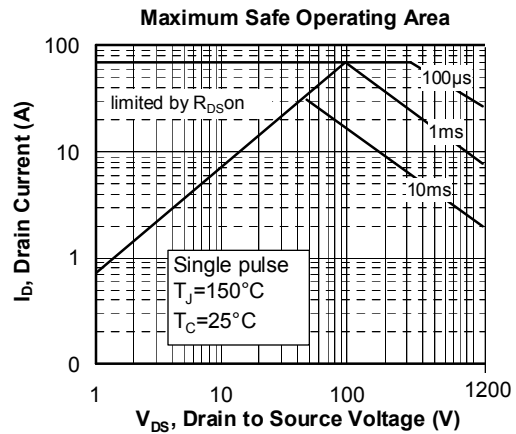
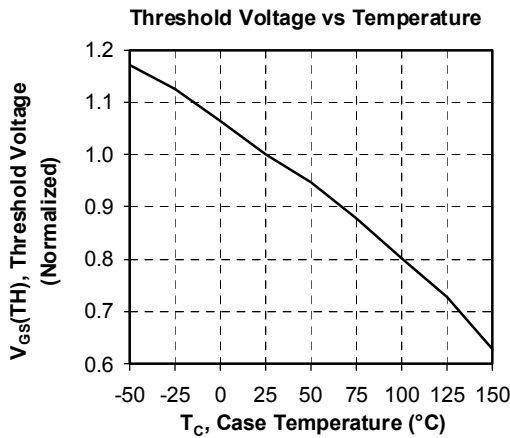
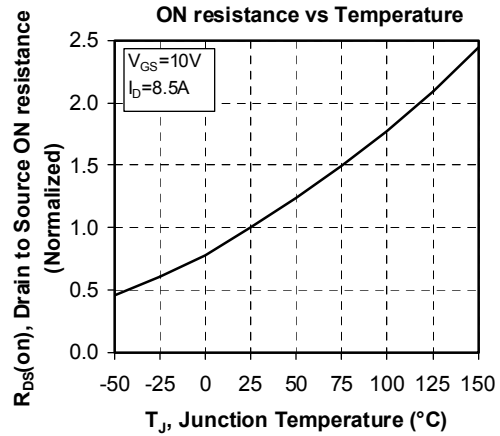
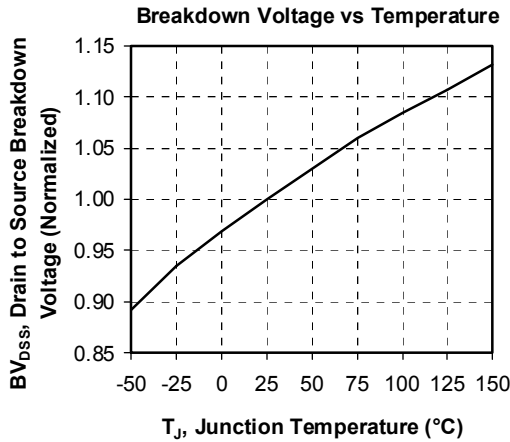

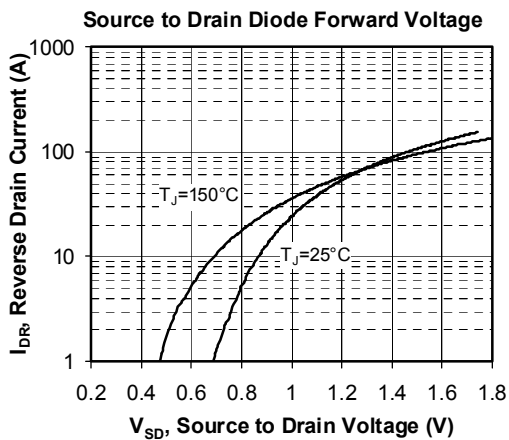
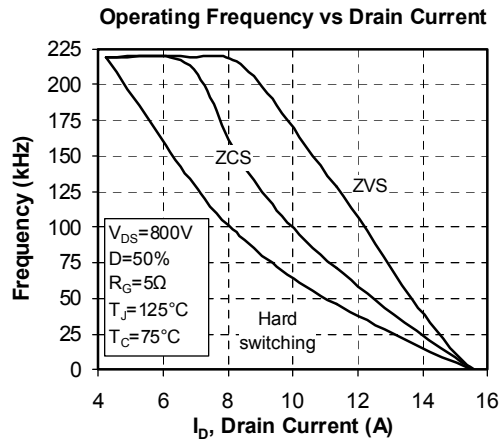
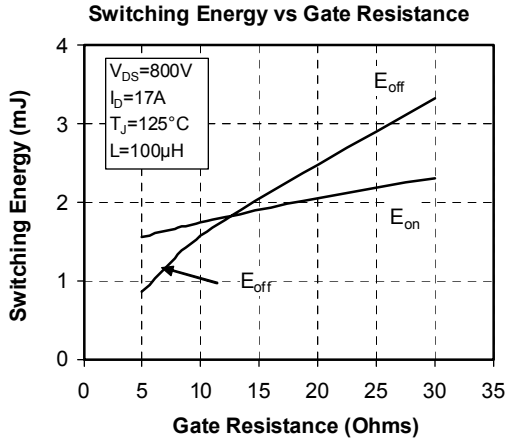
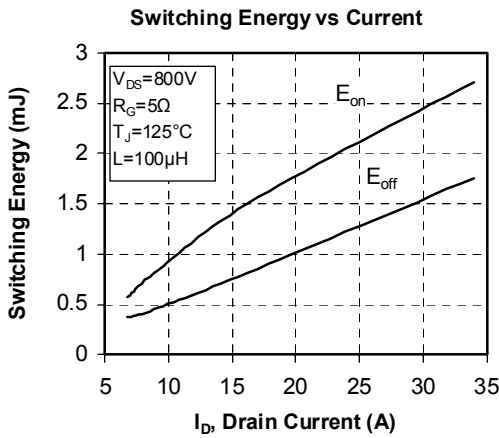
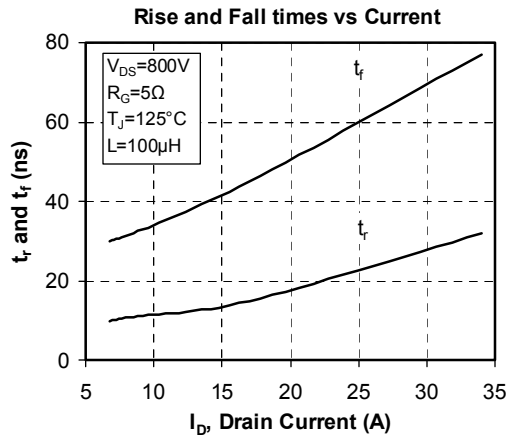
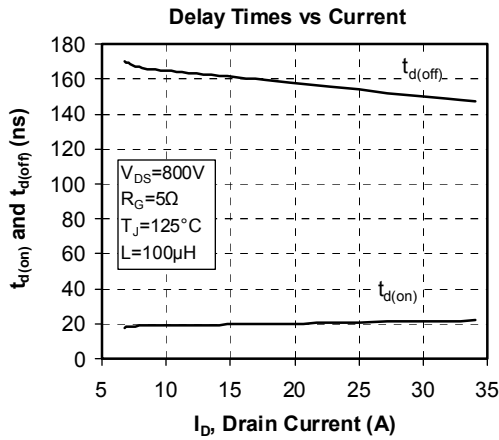

Microsemi reserves the right to change, without notice, the specifications and information contained herein

Microsemi's products are covered by one or more of U.S. patents 4,895,810 5,045,903 5,089,434 5,182,234 5,019,522 5,262,336 6,503,786 5,256,583 4,748,103 5,283,202 5,231,474 5,434,095 5,528,058 and foreign patents. U.S. and Foreign patents pending. All Rights Reserved.