



Chipsmall Limited consists of a professional team with an average of over 10 year of expertise in the distribution of electronic components. Based in Hongkong, we have already established firm and mutual-benefit business relationships with customers from,Europe,America and south Asia,supplying obsolete and hard-to-find components to meet their specific needs.

With the principle of “Quality Parts,Customers Priority,Honest Operation,and Considerate Service”,our business mainly focus on the distribution of electronic components. Line cards we deal with include Microchip,ALPS,ROHM,Xilinx,Pulse,ON,Everlight and Freescale. Main products comprise IC,Modules,Potentiometer,IC Socket,Relay,Connector.Our parts cover such applications as commercial,industrial, and automotives areas.

We are looking forward to setting up business relationship with you and hope to provide you with the best service and solution. Let us make a better world for our industry!



## Contact us

Tel: +86-755-8981 8866 Fax: +86-755-8427 6832

Email & Skype: info@chipsmall.com Web: www.chipsmall.com

Address: A1208, Overseas Decoration Building, #122 Zhenhua RD., Futian, Shenzhen, China



*Phase leg  
Schottky Series &  
parallel diodes  
MOSFET Power Module*

**$V_{DSS} = 500V$**   
 **$R_{DSon} = 19m\Omega \text{ max @ } T_j = 25^\circ C$**   
 **$I_D = 170A \text{ @ } T_c = 25^\circ C$**

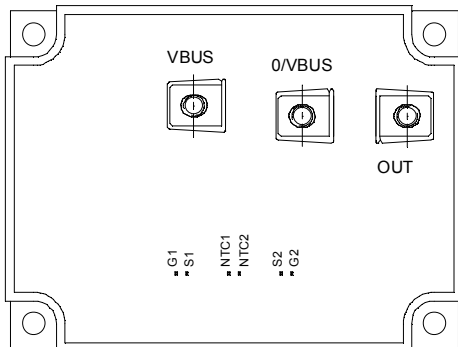
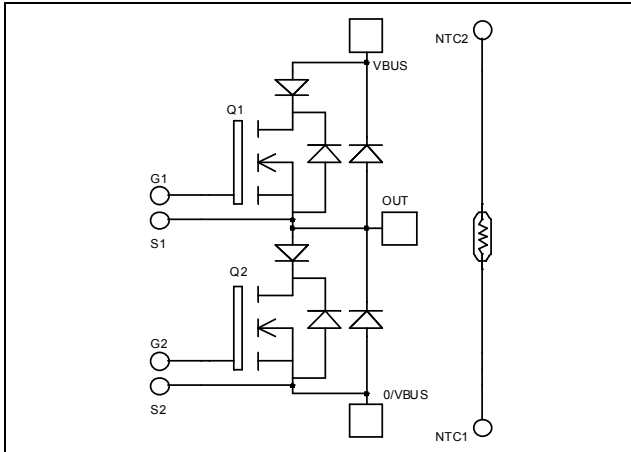

**Application**

- Motor control
- Switched Mode Power Supplies
- Uninterruptible Power Supplies

**Features**

- Power MOS 7<sup>®</sup> MOSFETs
  - Low  $R_{DSon}$
  - Low input and Miller capacitance
  - Low gate charge
  - Avalanche energy rated
  - Very rugged
- Kelvin source for easy drive
- Very low stray inductance
  - Symmetrical design
  - M5 power connections
- Internal thermistor for temperature monitoring
- High level of integration

**Benefits**

- Outstanding performance at high frequency operation
- Direct mounting to heatsink (isolated package)
- Low junction to case thermal resistance
- Solderable terminals for signal and M5 for power for easy PCB mounting

**Absolute maximum ratings**

Symbol	Parameter	Max ratings	Unit
$V_{DSS}$	Drain - Source Breakdown Voltage	500	V
$I_D$	Continuous Drain Current	$T_c = 25^\circ C$	170
		$T_c = 80^\circ C$	125
$I_{DM}$	Pulsed Drain current	360	A
$V_{GS}$	Gate - Source Voltage	$\pm 30$	V
$R_{DSon}$	Drain - Source ON Resistance	19	$m\Omega$
$P_D$	Maximum Power Dissipation	$T_c = 25^\circ C$	1250
$I_{AR}$	Avalanche current (repetitive and non repetitive)	46	A
$E_{AR}$	Repetitive Avalanche Energy	50	mJ
$E_{AS}$	Single Pulse Avalanche Energy	2500	

**CAUTION:** These Devices are sensitive to Electrostatic Discharge. Proper Handling Procedures Should Be Followed.

All ratings @  $T_j = 25^\circ\text{C}$  unless otherwise specified

## Electrical Characteristics

Symbol	Characteristic	Test Conditions	Min	Typ	Max	Unit
$BV_{DSS}$	Drain - Source Breakdown Voltage	$V_{GS} = 0V, I_D = 500\mu A$	500			V
$I_{DSS}$	Zero Gate Voltage Drain Current	$V_{GS} = 0V, V_{DS} = 500V$   $T_j = 25^\circ\text{C}$			500	$\mu A$
		$V_{GS} = 0V, V_{DS} = 400V$   $T_j = 125^\circ\text{C}$			2000	
$R_{DS(on)}$	Drain - Source on Resistance	$V_{GS} = 10V, I_D = 85A$			19	$m\Omega$
$V_{GS(th)}$	Gate Threshold Voltage	$V_{GS} = V_{DS}, I_D = 10mA$	3		5	V
$I_{GSS}$	Gate - Source Leakage Current	$V_{GS} = \pm 30V, V_{DS} = 0V$			$\pm 200$	nA

## Dynamic Characteristics

Symbol	Characteristic	Test Conditions	Min	Typ	Max	Unit
$C_{iss}$	Input Capacitance	$V_{GS} = 0V$ $V_{DS} = 25V$ $f = 1MHz$		22.4		nF
$C_{oss}$	Output Capacitance			4.8		
$C_{rss}$	Reverse Transfer Capacitance			0.36		
$Q_g$	Total gate Charge	$V_{GS} = 10V$ $V_{Bus} = 250V$ $I_D = 170A$		492		nC
$Q_{gs}$	Gate - Source Charge			132		
$Q_{gd}$	Gate - Drain Charge			260		
$T_{d(on)}$	Turn-on Delay Time	<b>Inductive switching @ <math>125^\circ\text{C}</math></b> $V_{GS} = 15V$ $V_{Bus} = 333V$ $I_D = 170A$ $R_G = 1\Omega$		18		ns
$T_r$	Rise Time			35		
$T_{d(off)}$	Turn-off Delay Time			87		
$T_f$	Fall Time			77		
$E_{on}$	Turn-on Switching Energy ❶	<b>Inductive switching @ <math>25^\circ\text{C}</math></b> $V_{GS} = 15V, V_{Bus} = 333V$ $I_D = 170A, R_G = 1\Omega$		3020		$\mu J$
$E_{off}$	Turn-off Switching Energy ❷			2904		
$E_{on}$	Turn-on Switching Energy ❶	<b>Inductive switching @ <math>125^\circ\text{C}</math></b> $V_{GS} = 15V, V_{Bus} = 333V$ $I_D = 170A, R_G = 1\Omega$		4964		$\mu J$
$E_{off}$	Turn-off Switching Energy ❷			3384		

## Series Schottky diode ratings and characteristics

Symbol	Characteristic	Test Conditions	Min	Typ	Max	Unit
$I_{F(AV)}$	Maximum Average Forward Current	50% duty cycle   $T_c = 85^\circ\text{C}$		120		A
$V_F$	Diode Forward Voltage	$I_F = 120A$		0.77		V
		$I_F = 120A$   $T_j = 125^\circ\text{C}$		0.62		

❶  $E_{on}$  includes diode reverse recovery.

❷ In accordance with JEDEC standard JESD24-1.



## Parallel diode ratings and characteristics

Symbol	Characteristic	Test Conditions		Min	Typ	Max	Unit
$I_{F(AV)}$	Maximum Average Forward Current	50% duty cycle	$T_c = 70^\circ\text{C}$		180		A
$V_F$	Diode Forward Voltage	$I_F = 180\text{A}$			1.6	1.8	V
		$I_F = 360\text{A}$			1.9		
		$I_F = 180\text{A}$	$T_j = 125^\circ\text{C}$		1.4		
$t_{rr}$	Reverse Recovery Time	$I_F = 180\text{A}$ $V_R = 400\text{V}$ $di/dt = 600\text{A}/\mu\text{s}$	$T_j = 25^\circ\text{C}$		130		ns
			$T_j = 125^\circ\text{C}$		170		
$Q_{rr}$	Reverse Recovery Charge	$I_F = 180\text{A}$ $V_R = 400\text{V}$ $di/dt = 600\text{A}/\mu\text{s}$	$T_j = 25^\circ\text{C}$		660		nC
			$T_j = 125^\circ\text{C}$		2760		

## Thermal and package characteristics

Symbol	Characteristic		Min	Typ	Max	Unit	
$R_{thJC}$	Junction to Case	Transistor			0.1	$^\circ\text{C}/\text{W}$	
		Series Diode			0.5		
		Parallel diode			0.32		
$V_{ISOL}$	RMS Isolation Voltage, any terminal to case $t = 1\text{ min}$ , $I_{isol} < 1\text{mA}$ , 50/60Hz		2500			V	
$T_J$	Operating junction temperature range		-40		150	$^\circ\text{C}$	
$T_{STG}$	Storage Temperature Range		-40		125		
$T_C$	Operating Case Temperature		-40		100		
Torque	Mounting torque	To heatsink	M5	2		3.5	N.m
		For terminals	M5	2		3.5	
Wt	Package Weight					620	g

## Temperature sensor NTC

Symbol	Characteristic	Min	Typ	Max	Unit
$R_{25}$	Resistance @ $25^\circ\text{C}$		68		$\text{k}\Omega$
$B_{25/85}$	$T_{25} = 298.16\text{ K}$		4080		K

$$R_T = \frac{R_{25}}{\exp\left[B_{25/85}\left(\frac{1}{T_{25}} - \frac{1}{T}\right)\right]}$$

T: Thermistor temperature  
 $R_T$ : Thermistor value at T

**Package outline**

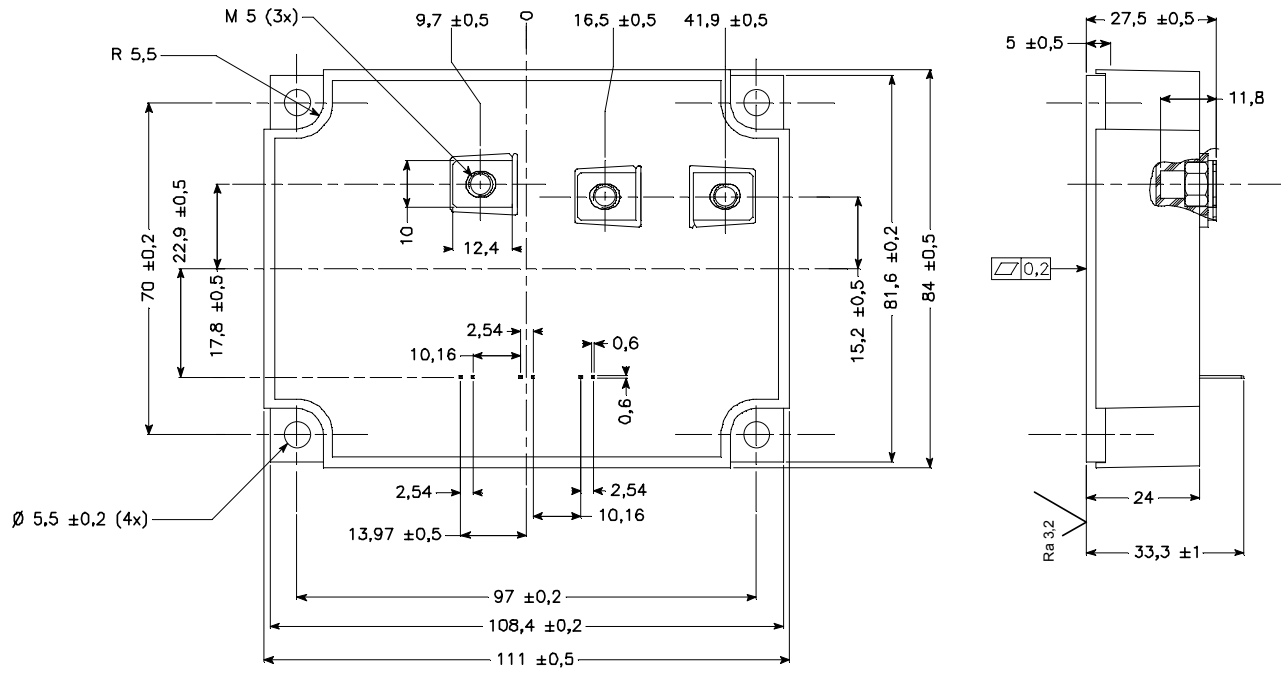

**Typical Performance Curve**

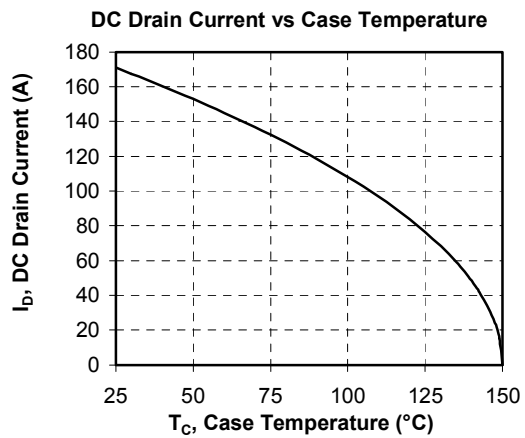
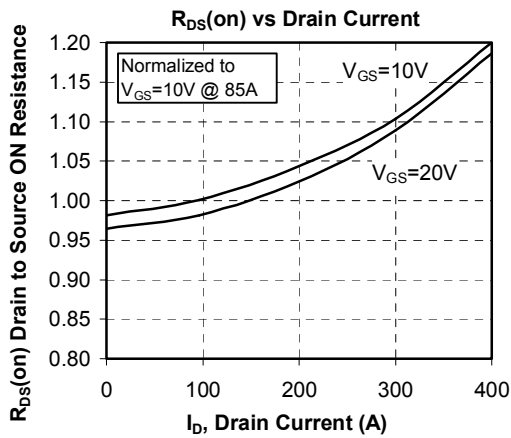
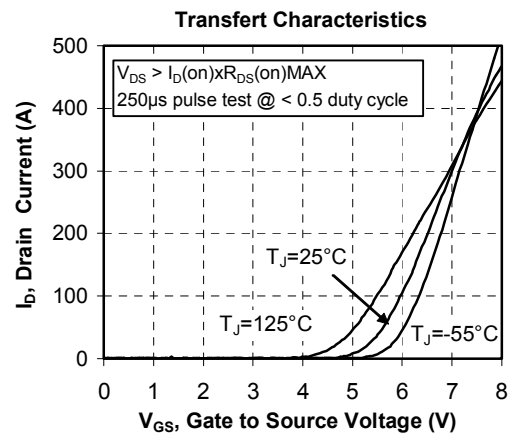
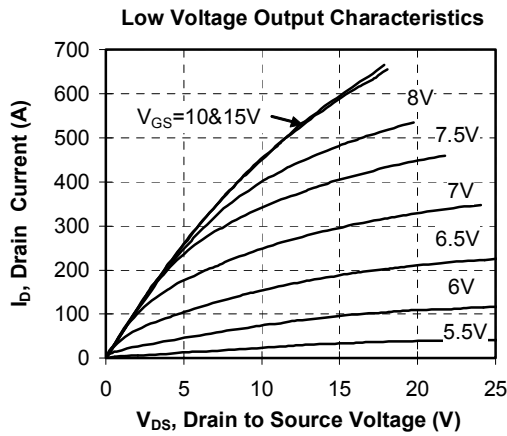
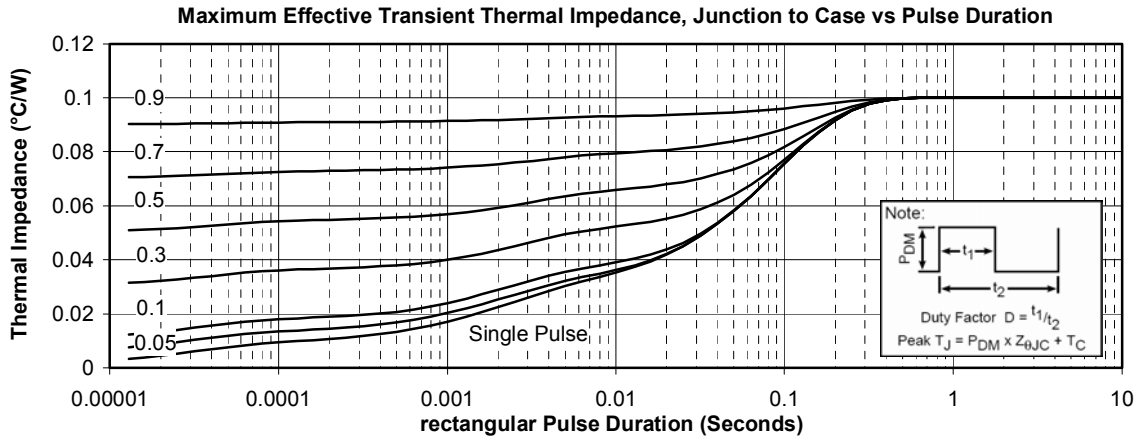

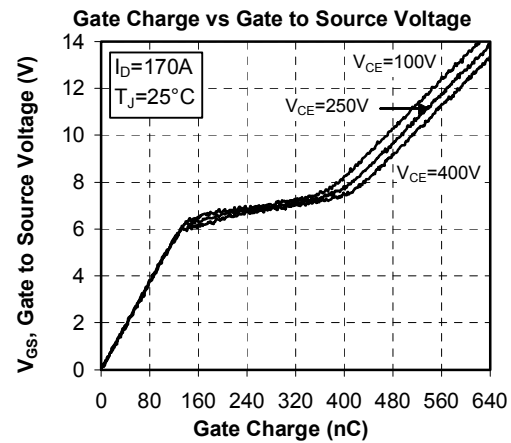
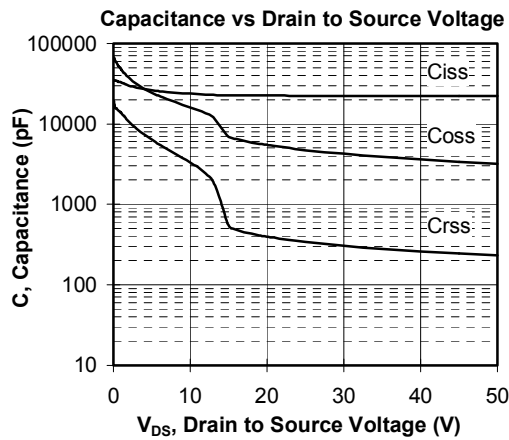
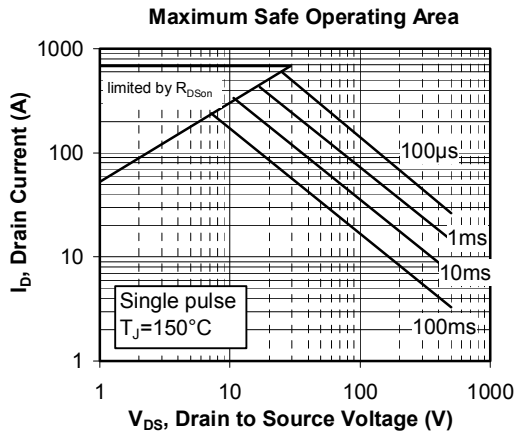
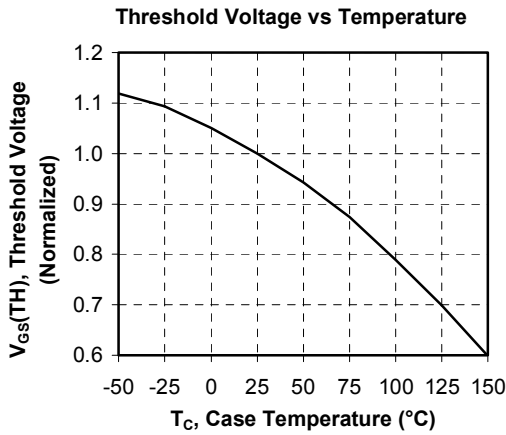
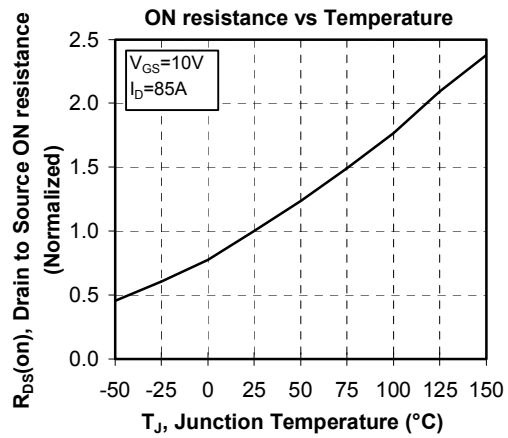
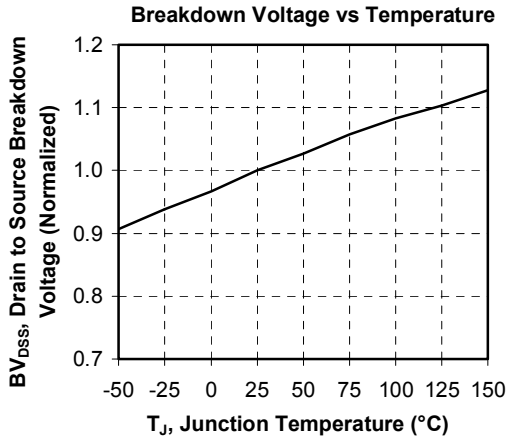

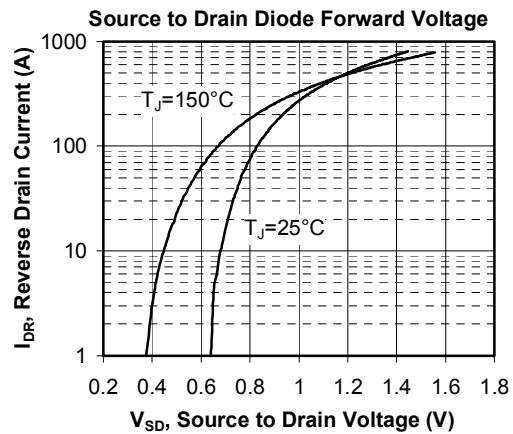
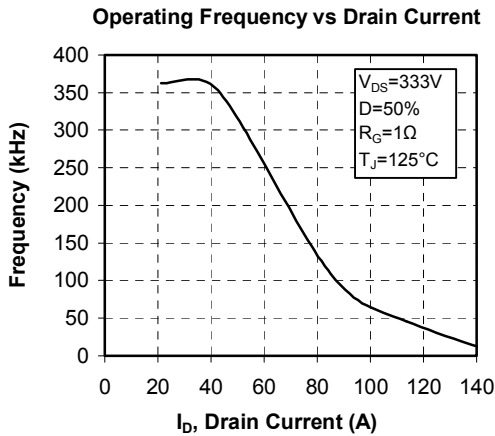
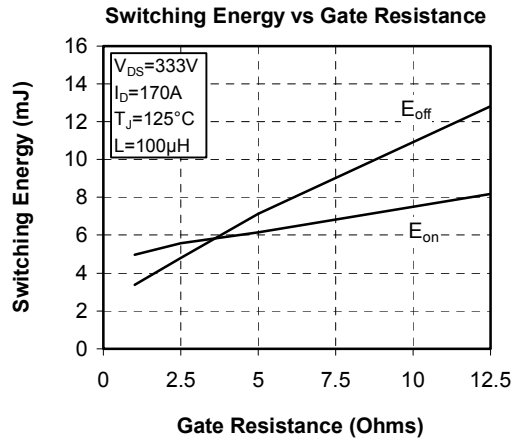
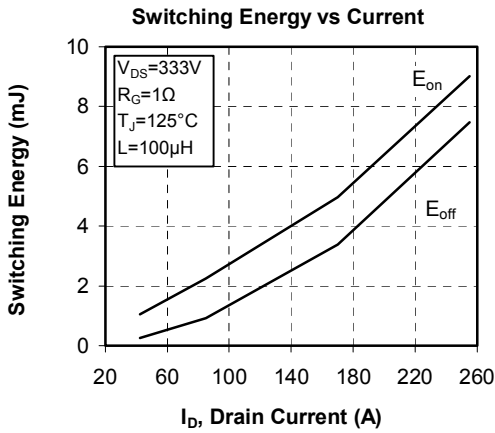
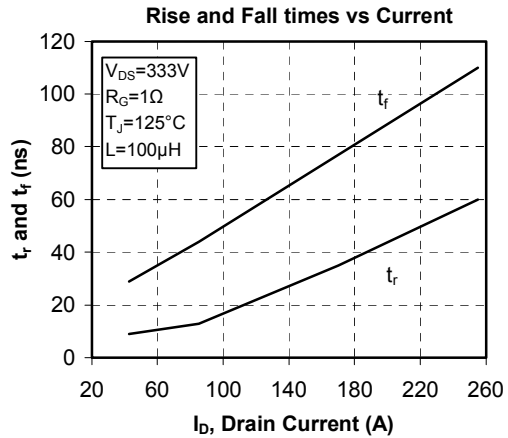
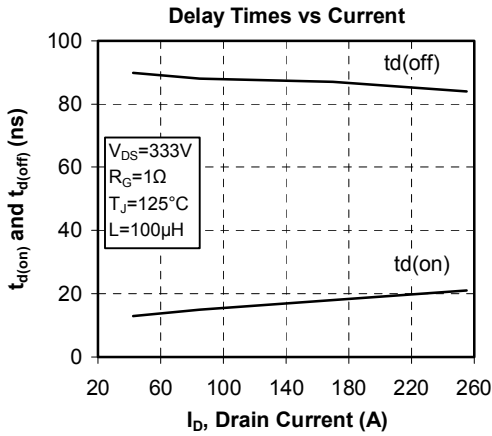

APT reserves the right to change, without notice, the specifications and information contained herein

APT's products are covered by one or more of U.S. patents 4,895,810 5,045,903 5,089,434 5,182,234 5,019,522 5,262,336 6,503,786 5,256,583 4,748,103 5,283,202 5,231,474 5,434,095 5,528,058 and foreign patents. U.S. and Foreign patents pending. All Rights Reserved.