



Chipsmall Limited consists of a professional team with an average of over 10 year of expertise in the distribution of electronic components. Based in Hongkong, we have already established firm and mutual-benefit business relationships with customers from,Europe,America and south Asia,supplying obsolete and hard-to-find components to meet their specific needs.

With the principle of “Quality Parts,Customers Priority,Honest Operation,and Considerate Service”,our business mainly focus on the distribution of electronic components. Line cards we deal with include Microchip,ALPS,ROHM,Xilinx,Pulse,ON,Everlight and Freescale. Main products comprise IC,Modules,Potentiometer,IC Socket,Relay,Connector.Our parts cover such applications as commercial,industrial, and automotives areas.

We are looking forward to setting up business relationship with you and hope to provide you with the best service and solution. Let us make a better world for our industry!



Contact us

Tel: +86-755-8981 8866 Fax: +86-755-8427 6832

Email & Skype: info@chipsmall.com Web: www.chipsmall.com

Address: A1208, Overseas Decoration Building, #122 Zhenhua RD., Futian, Shenzhen, China



Discontinued: AC optically coupled isolation type
Last time buy: August 31, 2011

Certified
 AQ2A2-ZP3/28VDC, AQ2A2-J-ZP3/28VDC,
 AQ3A2-ZP3/28VDC, AQ1AD2-3/28VDC
 and AQ2AD1-3/28VDC

Certified
 AQ2A2-ZP3/28VDC, AQ2A2-J-ZP3/28VDC,
 AQ3A2-ZP3/28VDC, AQ1AD2-3/28VDC
 and AQ2AD1-3/28VDC

Please contact us about
 TUV certified products.
 Certified
 AQ2A2-ZP3/28VDC, AQ2A2-J-ZP3/28VDC,
 AQ3A2-ZP3/28VDC, AQ1AD2-3/28VDC and
 AQ2AD1-3/28VDC

Certified
 AQ3A2-ZT4/32VDC,
 AQ3A2-J-ZT4/32VDC and
 AQ10A2-ZT4/32VDC

Panasonic
 ideas for life

**High capacity up to 10A
 PCB terminal type SSR**

AQ1 RELAYS

FEATURES

1. 10A high-capacity realized for PC board terminal (when using heat sink)
 SSR for compact PC boards with 10 A capacity that is two times greater than our previous model. It is suitable for long-life, highly frequent control.

2. VDE (EN60950-1) reinforced insulation compliant
 Fully satisfies demand for safety by guaranteeing compliance with EN60950-1 safety standard and featuring 3,000 V reinforced insulation (AQ3A2-ZT4/32VDC, AQ3A2-J-ZT4/32VDC and AQ10A2-ZT4/32VDC).

3. Superior anti-vibration and anti-shock characteristics
 The body is molded as a single unit with flame resistant resin which makes it highly resistant against vibration and shock, and gives it superior protection from environment. The body can also be washed.

4. Vertical types with SIL terminal arrangement and flat types are available.
 1) The vertical type is available in thicknesses of 10 mm (2 A and 3 A types) and 12 mm (5 A and 10 A types). Terminal arrangement is SIL in integral multiples of 2.54 mm (0.1 inch).
 2) The height of the flat type is 12 mm. The terminal arrangement is DIL in integral multiples of 2.54 mm.

5. Reduced noise generation
 The load will operate at close to zero voltage even when the input signal is applied during a cycle. Also, even if an input signal is cancelled during a cycle, the load is cut off at close to zero current. For this reason, hardly any noise is produced and radio frequency interference (RFI) and electromagnetic interference (EMI) are kept to a minimum.

6. Built-in snubber circuit prevents malfunction.

TYPICAL APPLICATIONS

- Printing machines
- Packing machines
- Traffic signal control
- Automatic ticket punchers
- Terminal equipment of data processing
- Computer peripherals
- NC machines

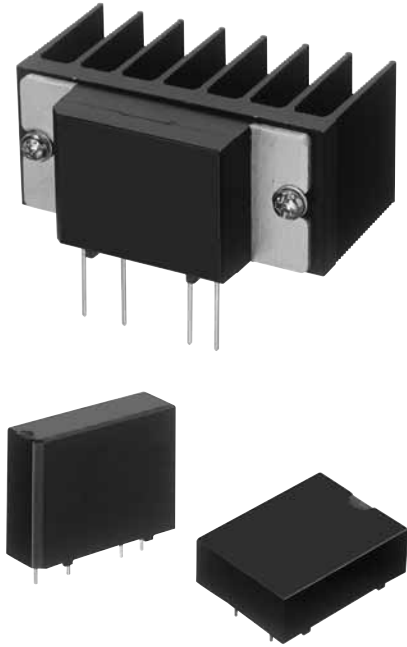

Compliance with RoHS Directive

ORDERING INFORMATION



Load current
 1 A, 2 A, 3 A, 5 A, 10 A

Load voltage
 2: 75 to 250 V AC
 D1: 3 to 60 V DC
 D2: 10 to 200 V DC

Shape
 Nil: Vertical type
 J: Flat type

Nil: DC output
 ⚠ ZP: Zero-cross AC output (Photocoupler)
 ZT: Zero-cross AC output (Phototriac coupler)

Input voltage
 3/28 V DC: 3 to 28 V DC
 4/32 V DC: 4 to 32 V DC

* Random types are available upon request.

TYPES

1. AQ1 Solid State Relays

Load	Isolation	Zero-cross function	Type	Load voltage	Load voltage	Input voltage	Part No.
AC	Phototriac coupler	Zero-cross*1	Vertical	3 A	75 to 250 V AC	4 to 32 V DC	AQ3A2-ZT4/32VDC
			Flat	3 A	75 to 250 V AC	4 to 32 V DC	AQ3A2-J-ZT4/32VDC
			Vertical	10 A*2	75 to 250 V AC	4 to 32 V DC	AQ10A2-ZT4/32VDC
AC	Optically coupled isolation	 Zero-cross	Vertical	2 A	75 to 250 V AC	3 to 28 V DC	AQ2A2-ZP3/28VDC
			Flat	2 A	75 to 250 V AC	3 to 28 V DC	AQ2A2-J-ZP3/28VDC
			Vertical	5 A*3	75 to 250 V AC	3 to 28 V DC	AQ5A2-ZP3/28VDC
DC		-	Vertical	1 A	10 to 200 V DC	3 to 28 V DC	AQ1AD2-3/28VDC
			Vertical	2 A	3 to 60 V DC	3 to 28 V DC	AQ2AD1-3/28VDC

Standard packing: Carton 20 pcs., Case 200 pcs.
 Notes: *1 Random type also available. Please inquire.
 *2 5 A without heat sink
 *3 3 A without heat sink



2. Heat sink for AQ1 solid state relay

Product name	Part No.
Heat sink for  AQ5A2-ZP3/28VDC and AQ10A2-ZT4/32VDC	AQ-HS-5A

Standard packing: Carton 20 pcs., Case 200 pcs.



SPECIFICATIONS

1. Rating (at 20°C 68°F, Ripple factor: less than 1%)

Item	Type	AC output type				DC output type		Remarks
		Zero-cross				1 A type	2 A type	
		3 A type	10 A type	2 A type	5 A type			
Input side	Input voltage	4 to 32 V DC		 3 to 28 V DC	3 to 28 V DC			
	Input impedance	—		Approx. 1.6 kΩ		Approx. 1.6 kΩ		
	Input current, max.	20 mA		—		—		
	Drop-out voltage, min.	1.0 V		0.8 V		0.8 V		
Load side	Max. load current	3 A	10 A*1	2 A	5 A*2	1 A	2 A	Refer to REFERENCE DATA "1. Load current vs. ambient temperature characteristics".
	Load voltage	75 to 250 V AC				10 to 200 V DC	3 to 60 V DC	
	Non-repetitive surge current	100 A		 80 A	100 A	5 A (1 s)		AC: In one cycle at 60 Hz, DC: 1s
	Max. "OFF-state" leakage current	5 mA				1 mA		AC: at 200 V, 60Hz DC: When maximum load voltage is applied.
	Max. "ON-state" voltage drop	1.6 V				1.6 V	2.3 V	At Max. carrying current
	Min. load current	50 mA*3				5 mA*3		

Notes: *1 When heat sink (AQ-HS-5A) is installed. The max. load current is 5 A when heat sink is not installed.
 *2 When heat sink (AQ-HS-5A) is installed. The max. load current is 3 A when heat sink is not installed.
 *3 When load current is below the rating, refer to "Cautions for Use".

2. Characteristics (at 20°C 68°F, Ripple factor: less than 1%)

Item	Type	AC output				DC output	Remarks
		Zero-cross					
		3 A type	10 A type	 2 A type	5 A type		
Operate time, Max.		1/2 cycle of voltage sine wave + 1 ms				0.5 ms	
Release time, Max.		1/2 cycle of voltage sine wave + 1 ms				2 ms	
Insulation resistance, Min.		100 M Ω for input, output and case				100 M Ω for input, output	at 500 V DC
Breakdown voltage		4,000 Vrms between input and output 2,500 Vrms between input, output and case		 3,000 Vrms between input and output	3,000 Vrms between input and output 1,500 Vrms between input, output and case	3,000 Vrms between input-output	For 1 minute
Vibration resistance	Destructive	10 to 55 Hz at double amplitude of 2 mm				10 to 55 Hz at double amplitude of 2 mm	1 hour for X, Y, Z axis
	Functional	10 to 55 Hz at double amplitude of 2 mm				10 to 55 Hz at double amplitude of 2 mm	10 minutes for X, Y, Z axis
Shock resistance	Destructive	Min. 980 m/s ² {100 G}				Min. 980 m/s ² {100 G}	5 times each for X, Y, Z axis
	Functional	Min. 980 m/s ² {100 G}				Min. 980 m/s ² {100 G}	4 times each for X, Y, Z axis
Ambient temperature		-30°C to +80°C -22°F to +176°F					
Storage temperature		-30°C to +100°C -22°F to +212°F					
Operational method		Zero-cross (Turn-ON and Turn-OFF)				—	



Discontinued: AC optically coupled isolation type
Last time buy: August 31, 2011

AQ1

REFERENCE DATA

1.-(1) Load current vs. ambient temperature
 (AC output, 3 A type) Part No.: AQ3A2-ZT4/32VDC
 and AQ3A2-J-ZT4/32VDC
 Allowable ambient temperature:
 -30°C to +80°C -22°F to +176°F

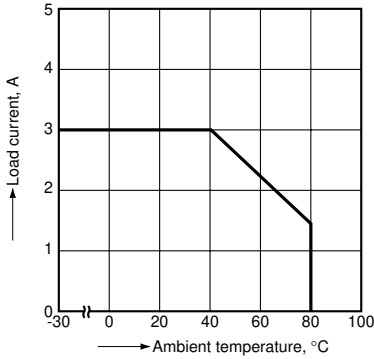

1.-(2) Load current vs. ambient temperature
 (AC output, 10 A type) Part No.: AQ10A2-ZT4/32VDC
 (A) When not using a heat sink
 (B) When using a standard heat sink AQ-HS-5A
 (When attached to a heat sink, use a heat conductive
 compound (Ex. Toshiba silicone YG6111 or TSK5303)
 of similar coating to improve cooling.)

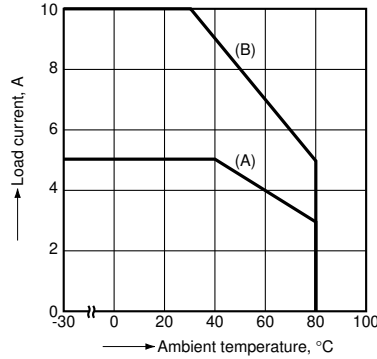

1.-(3) Load current vs. ambient temperature
 (AC output, 2 A type) Part No.: AQ2A2-ZP3/28VDC
 and AQ2A2-J-ZP3/28VDC
 Allowable ambient temperature:
 -30°C to +80°C -22°F to +176°F

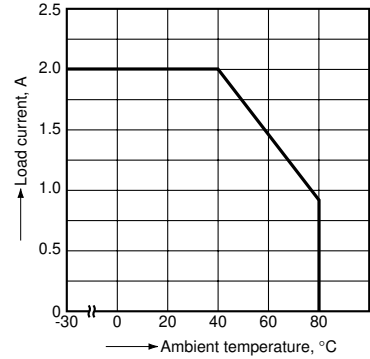

1.-(4) Load current vs. ambient temperature
 (AC output, 5 A type) Part No.: AQ5A2-ZP3/28VDC
 (A) When not using a heat sink
 (B) When using a standard heat sink AQ-HS-5A
 (When attached to a heat sink, use a heat conductive
 compound (Ex. Toshiba silicone YG6111 or TSK5303)
 of similar coating to improve cooling.)

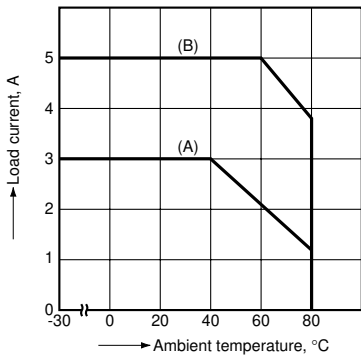

1.-(5) Load current vs. ambient temperature
 (DC output, 1 A and 2 A types) Part No.: AQ1AD2-3/
 28VDC and AQ2AD1-3/28VDC
 Allowable ambient temperature:
 -30°C to +80°C -22°F to +176°F

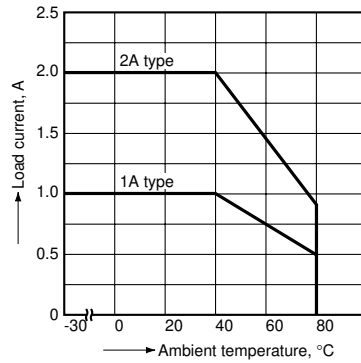

2.-(1) Non-repetitive surge current vs.
 carrying time
 (AC output, 3 A and 10 A types)
 Part No.: AQ3A2-ZT4/32VDC,
 AQ3A2-J-ZT4/32VDC
 and AQ10A2-ZT4/32VDC

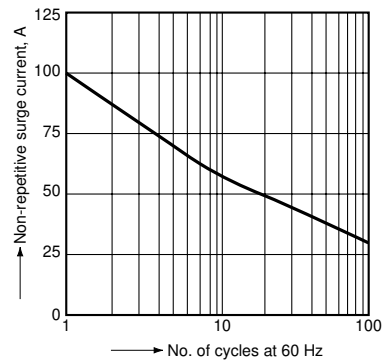

2.-(2) Non-repetitive surge current vs.
 carrying time
 (AC output, 2 A type) Part No.: AQ2A2-ZP3/28VDC
 and AQ2A2-J-ZP3/28VDC

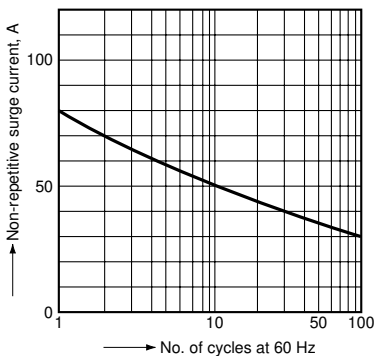

2.-(3) Non-repetitive surge current vs.
 carrying time
 (AC output, 5 A type) Part No.: AQ5A2-ZP3/28VDC

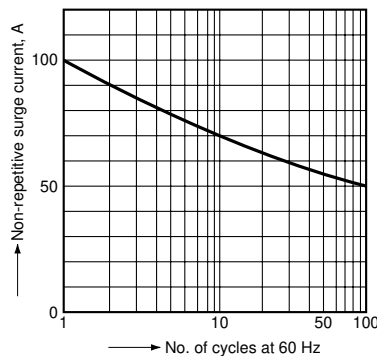

2.-(4) Non-repetitive surge current vs.
 carrying time
 (DC output) Part No.: AQ1AD2-3/28VDC and
 AQ2AD1-3/28VDC

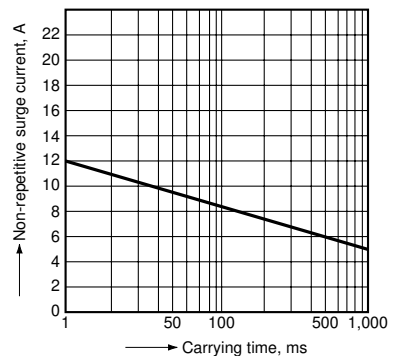

3.-(1) Input current vs. input voltage characteristics

(AC output, 3 A and 10 A types)
 Part No.: AQ3A2-ZT4/32VDC, AQ3A2-J-ZT4/32VDC and AQ10A2-ZT4/32VDC

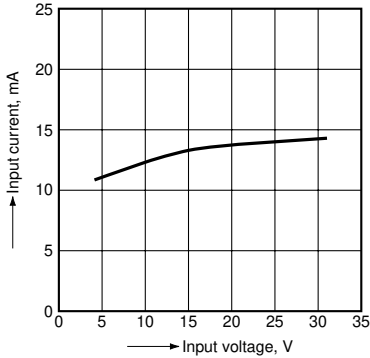

3.-(2) Input current vs. input voltage characteristics

(AC output, 2 A and 5 A types)
 ⚠ Part No.: AQ2A2-ZP3/28VDC, AQ2A2-J-ZP3/28VDC and AQ5A2-ZP3/28VDC
 (DC output)
 Part No.: AQ1AD2-3/28VDC and AQ2AD1-3/28VDC

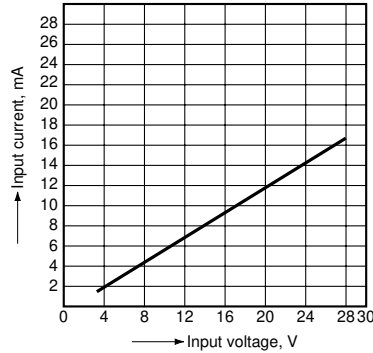

4.-(1) Load current vs. ambient temperature characteristics for adjacent mounting

(AC output, 3A vertical type)
 Part No.: AQ3A2-ZT4/32VDC

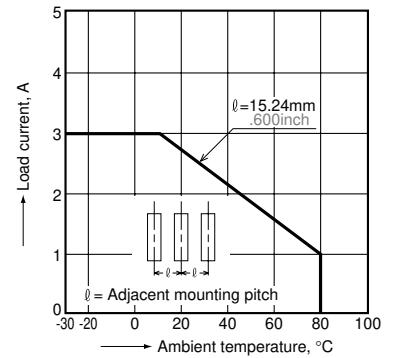

4.-(2) Load current vs. ambient temperature characteristics for adjacent mounting

(DC output, 10A type)
 Part No.: AQ10A2-ZT4/32VDC (without heat sink)

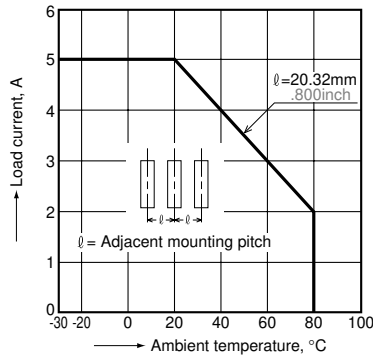

DIMENSIONS (mm inch)

The CAD data of the products with a **CAD Data** mark can be downloaded from: <http://panasonic-electric-works.net/ac>

1. AC output, **2A** and 3A types (Vertical)

CAD Data

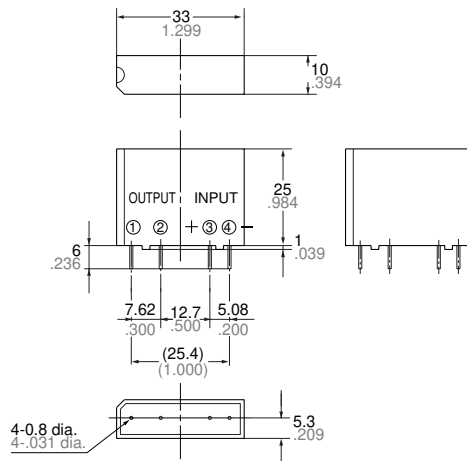

General tolerance: $\pm 0.5 \pm 0.020$

Mounting hole location (Copper-side view)

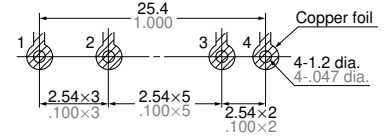

Schematic

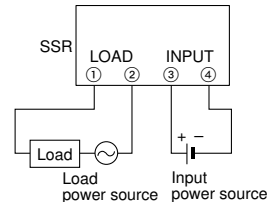

Tolerance: $\pm 0.1 \pm 0.004$

AQ1

2. AC output, 2A and 3A types (Flat)

CAD Data

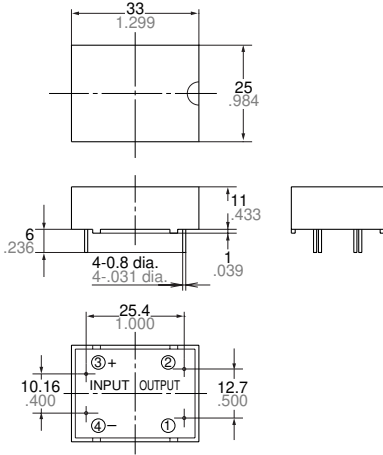

Mounting hole location (Copper-side view)

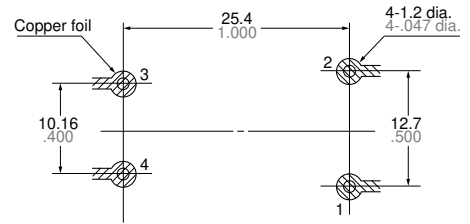

Schematic

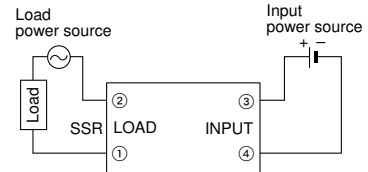

General tolerance: $\pm 0.5 \pm 0.20$

Tolerance: $\pm 0.1 \pm 0.04$

3. AC output, 5A and 10A types

CAD Data

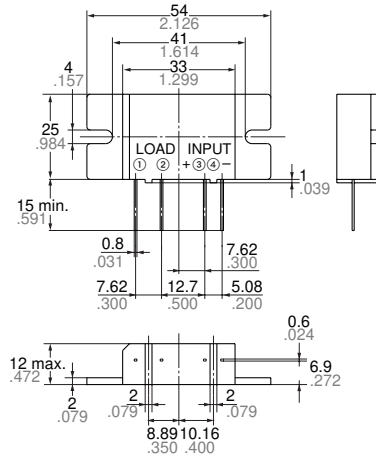
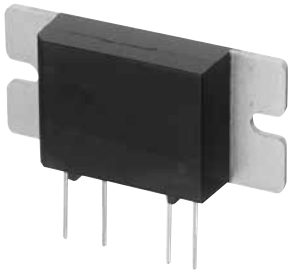

Mounting hole location (Copper-side view)

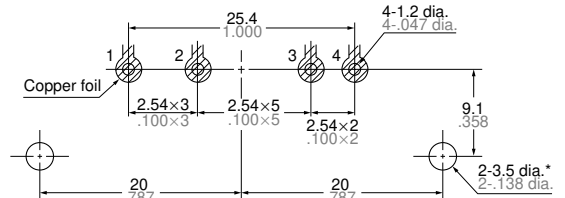

* There 2 holes are not necessary when not using heat sink (AQ-HS-5A)

Schematic

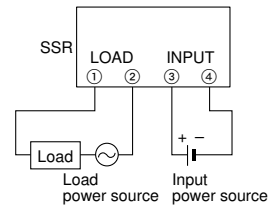

General tolerance: $\pm 0.5 \pm 0.20$

Tolerance: $\pm 0.1 \pm 0.04$

4. Heat sink (for AQ10A2-ZT4/32VDC and AQ5A2-ZP3/28VDC)

CAD Data

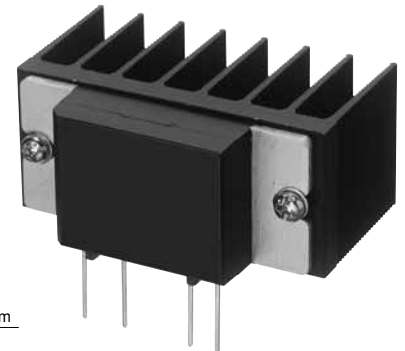
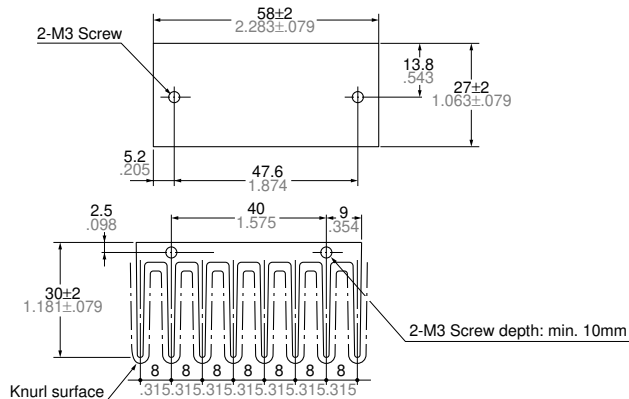

Heat sink attached to AQ1 relay

General tolerance: $\pm 0.5 \pm 0.20$

Note: When using heat sink, please refer to "Thermal Design"

5. DC output, 1A and 2A types

CAD Data

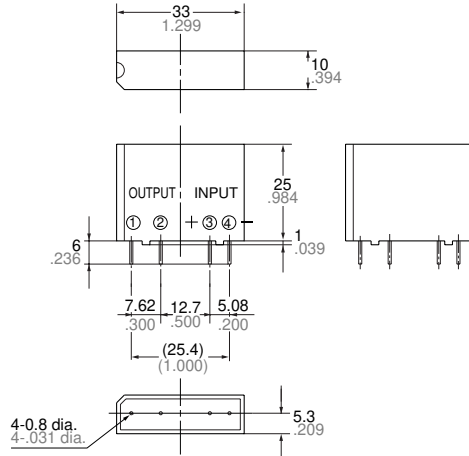

General tolerance: $\pm 0.5 \pm .020$

Mounting hole location (Copper-side view)

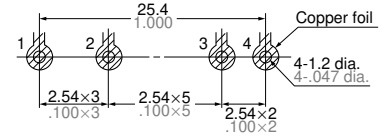

Schematic

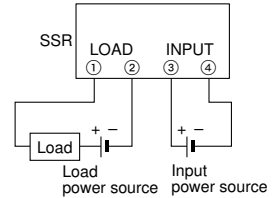

Tolerance: $\pm 0.1 \pm .004$

NOTE

1. When using bent output terminals
 To avoid applying mechanical stress on the main unit and molded section of the solid state relay, radio pliers should be used to grasp the terminals between the point of bending and the molded case when making the bends.

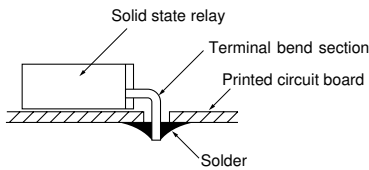

2. When a heat sink is mounted on the 5 A or 10 A type

The heat sink (AQ-HS-5A) or a radiator which can make good contact should be used. If a heat sink is used in which the contact condition is bad, a heat conducting compound should be used to improve the heat radiation. (Ex. Silicon compound Toshiba silicon YG6111 or TSK5303) The compound should be applied between the heat sink and the AQ1.

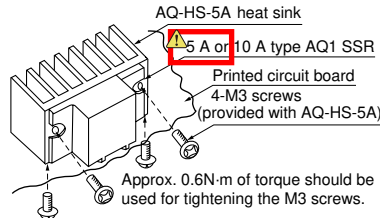

Recommended Temperature Controllers

<KT4H Temperature Controller>

Our temperature controller is recommended for use with our Solid State Relays.

Features

- Data can be collected using the RS485 communications interface via a PLC.
- Improved visibility using a negative type LCD and backlight.
- Depth-wise length (chassis dimension) is 56 mm 2.205 inch.

Substitute part numbers

Power supply	Control output	Part No.
100 to 240 V AC	Relay contact	AKT4H111100

*For detailed product information about temperature controllers, please refer to our website:
http://panasonic-denko.co.jp/ac/e/fasys/component/temperature_controller/

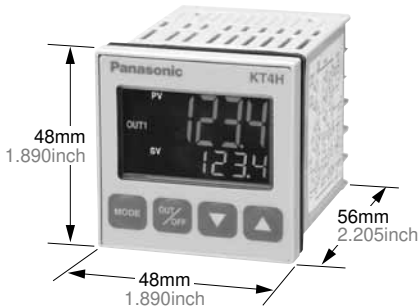

For Cautions for Use.