



Chipsmall Limited consists of a professional team with an average of over 10 year of expertise in the distribution of electronic components. Based in Hongkong, we have already established firm and mutual-benefit business relationships with customers from,Europe,America and south Asia,supplying obsolete and hard-to-find components to meet their specific needs.

With the principle of “Quality Parts,Customers Priority,Honest Operation,and Considerate Service”,our business mainly focus on the distribution of electronic components. Line cards we deal with include Microchip,ALPS,ROHM,Xilinx,Pulse,ON,Everlight and Freescale. Main products comprise IC,Modules,Potentiometer,IC Socket,Relay,Connector.Our parts cover such applications as commercial,industrial, and automotives areas.

We are looking forward to setting up business relationship with you and hope to provide you with the best service and solution. Let us make a better world for our industry!



Contact us

Tel: +86-755-8981 8866 Fax: +86-755-8427 6832

Email & Skype: info@chipsmall.com Web: www.chipsmall.com

Address: A1208, Overseas Decoration Building, #122 Zhenhua RD., Futian, Shenzhen, China



**Super miniature
TSON package,
Capacitor Coupled
isolation type**

**PhotoMOS®
CC TSON CxR
(AQY2)**

New

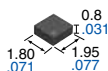

mm inch

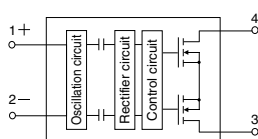

RoHS compliant

FEATURES

1. Super miniature TSON package contributes to space savings and high density mounting. 3.5 mm² mounting area achieved. Approx. 46 % less than previous product (SON type).

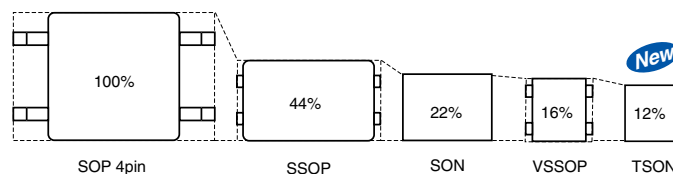

- 2. Low current consumption (input current: Max. 0.2 mA)**
- 3. Guaranteed performance at high temperature (Max. 105°C 221°F)**
- 4. Voltage driving type (3 V to 5 V)**
- 5. Input current of CC type is less than half of previous products, contributing energy saving of device and increases drivability**

Comparison with previous products

		CC type (AQY2C1R2P V _{IN} = 5 V)	HS type (AQY232S)	GU type (AQY212S)
Input current	Typical	0.09 mA	0.35 mA	0.9 mA
	Maximum	0.2 mA	0.5 mA	3 mA

TYPICAL APPLICATIONS

- 1. Measuring equipment: IC tester, probe cards, board tester and other testing equipment**
- 2. Telecommunication equipment**
- 3. Security, voltage operating equipment application for requiring low electricity consumption.**
 - Security equipment: Security camera, intruder detection
 - Disaster-preventing equipment: Fire alarm, smoke, heat and fire detectors
 - Industrial equipment: Electric measuring equipment, Industrial measuring equipment
 - Electric meter, Gas meter and other meters.

*Does not support automotive application.

OPERATING PRINCIPLE

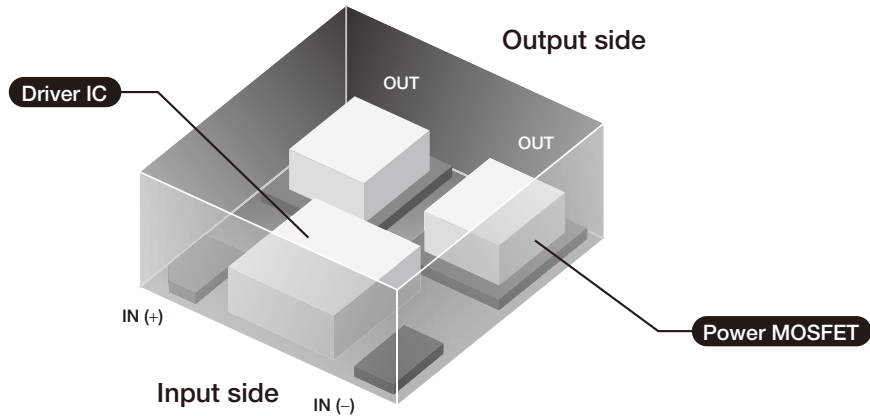

■ **When operated**

When signal voltage is applied to the input terminal, the oscillation circuit in the driver IC operates.

The oscillating input signal is converted to DC voltage by the rectifier circuit after passing through the isolation capacitor in the driver IC.

The DC voltage that was converted then passes through the control circuit in the driver IC and charges the MOSFET gate on the output side.

When the gate voltage of MOSFET supplied from the driver IC reaches a preset voltage value, the MOSFET begins to conduct and turns on the load.

■ **When turned off**

When the signal voltage at the input terminal is cut off, the oscillation circuit in the driver IC stops.

When oscillation of the input signal stops, the driver IC voltage decreases.

When the voltage supplied from the driver IC decrease, the control circuit rapidly discharges the gate charge of MOSFET.

This operation makes MOSFET stop conducting and turns off the load.

TYPES

Type	Output rating*1		Part No. (Tape and reel packing style)*2		Packing quantity in the tape and reel
	Load voltage	Load current	Picked from the 1 and 2-pin side	Picked from the 3 and 4-pin side	
AC/DC dual use	30 V	0.75 A	AQY2C1R6PX	AQY2C1R6PZ	3,500 pcs.
	40 V	0.3 A	AQY2C1R2PX	AQY2C1R2PZ	

Notes: *1. Indicate the peak AC and DC values.

*2. Only tape and reel package is available.

For space reasons, only "1R6" or "1R2" is marked on the product as the part number.

RATING

1. Absolute maximum ratings (Ambient temperature: 25°C 77°F)

Item		Symbol	AQY2C1R6P	AQY2C1R2P	Remarks
Input side	Input voltage	V_{IN}	5.5 V		
	Input reverse voltage	V_{RIN}	0.2 V		
	Power dissipation	P_{in}	1.2 mW		
Output side	Load voltage (peak AC)	V_L	30 V	40 V	
	Continuous load current	I_L	0.75 A	0.3 A	Peak AC, DC
	Peak load current	I_{peak}	1.5 A	0.75 A	100 ms (1shot), $V_L = DC$
	Power dissipation	P_{out}	250 mW		
Total power dissipation		P_T	250 mW		
I/O isolation voltage		V_{iso}	200 V AC		
Operating temperature		T_{opr}	-40°C to +105°C -40°F to +221°F		Non-condensing at low temperatures
Storage temperature		T_{stg}	-40°C to +125°C -40°F to +257°F		

2. Electrical characteristics (Ambient temperature: 25°C 77°F)

Item			Symbol	AQY2C1R6P	AQY2C1R2P	Test condition	
Input	Operate voltage	Typ.	V_{Fon}	1.7 V	1.8 V	$\Delta V_{IN}/\Delta t \geq 100$ mV/ms AQY2C1R6P: $I_L = 100$ mA AQY2C1R2P: $I_L = \text{Max.}$	
		Max.		2.5 V			
	Turn off voltage	Min.	V_{Foff}	0.5 V		$\Delta V_{IN}/\Delta t \geq 100$ mV/ms AQY2C1R6P: $I_L = 100$ mA AQY2C1R2P: $I_L = \text{Max.}$	
		Typ.		1.5 V	1.4 V		
	Input current		Typ.	I_{IN}	0.04 mA		$V_{IN} = 3.3$ V
			Max.		0.1 mA		
Typ.			0.09 mA		$V_{IN} = 5$ V		
Max.			0.2 mA				
Output	On resistance	Typ.	R_{on}	0.22 Ω	0.9 Ω	$V_{IN} = 3.3$ V, $I_L = \text{Max.}$	
		Max.		—			
		Typ.		0.2 Ω		$V_{IN} = 5$ V, $I_L = \text{Max.}$	
		Max.		0.4 Ω			
	Output capacitance	Typ.	C_{out}	40 pF	14.5 pF	$V_{IN} = 0$ V, $f = 1$ MHz, $V_B = 0$ V	
		Max.		100 pF	18 pF		
Transfer characteristics	Turn on time*	Typ.	T_{on}	0.25 ms	0.15 ms	$V_{IN} = 3.3$ V, $V_L = 10$ V, $R_L = 100$ Ω	
		Max.		1 ms			
		Typ.		0.12 ms		$V_{IN} = 5$ V, $V_L = 10$ V, $R_L = 100$ Ω	
		Max.		0.5 ms			
	Turn off time*	Typ.	T_{off}	0.06 ms		$V_{IN} = 3.3$ V, $V_L = 10$ V, $R_L = 100$ Ω	
		Max.		0.2 ms			
		Typ.		0.1 ms		$V_{IN} = 5$ V, $V_L = 10$ V, $R_L = 100$ Ω	
		Max.		0.5 ms			
	I/O capacitance	Typ.	C_{iso}	1.2 pF		$f = 1$ MHz, $V_B = 0$ V	
		Max.		3 pF			

*Turn on/Turn off time

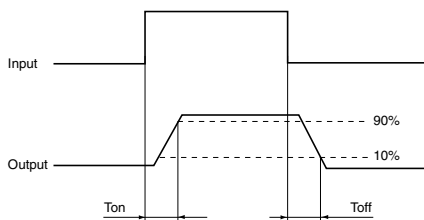

RECOMMENDED OPERATING CONDITIONS

Please obey the following conditions to ensure proper device operation and resetting.

Item	Symbol	Minimum	Typical	Maximum	Unit
Input voltage	V_{IN}	3	—	5	V

REFERENCE DATA

1. Load current vs. ambient temperature characteristics

Allowable ambient temperature: -40°C to $+105^{\circ}\text{C}$
 -40°F to $+221^{\circ}\text{F}$

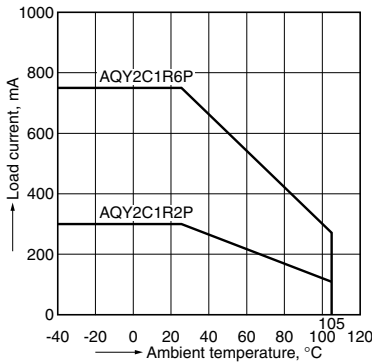

2. On resistance vs. ambient temperature characteristics

Measured portion: between terminals 3 and 4,
 Input voltage: 5V
 Load voltage: 10V (DC)
 Continuous load current: 750mA (DC) AQY2C1R6P
 300mA (DC) AQY2C1R2P

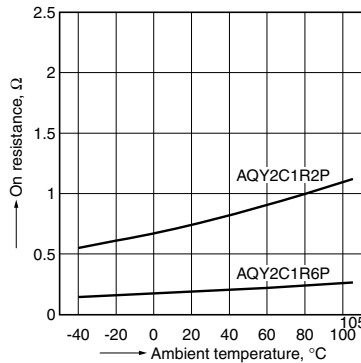

3. Turn on time vs. ambient temperature characteristics

Measured portion: between terminals 3 and 4,
 Input voltage: 5V
 Load voltage: 10V (DC)
 Continuous load current: 100mA

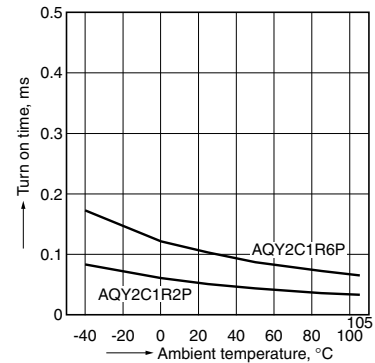

4. Turn off time vs. ambient temperature characteristics

Measured portion: between terminals 3 and 4,
 Input voltage: 5V
 Load voltage: 10V (DC)
 Continuous load current: 100mA

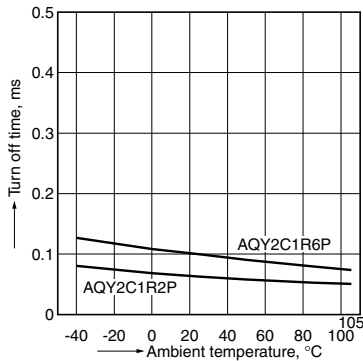

5. Operate voltage vs. ambient temperature characteristics

Measured portion: between terminals 3 and 4
 Load voltage: 10V (DC)
 Continuous load current: 100mA (DC) AQY2C1R6P
 300mA (DC) AQY2C1R2P

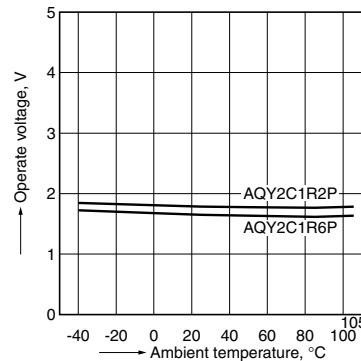

6. Turn off voltage vs. ambient temperature characteristics

Measured portion: between terminals 3 and 4
 Load voltage: 10V (DC)
 Continuous load current: 100mA (DC) AQY2C1R6P
 300mA (DC) AQY2C1R2P

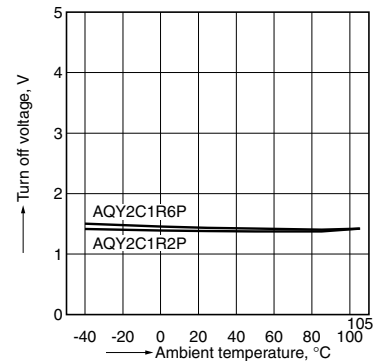

7. Input current vs. ambient temperature characteristics

Input voltage: 3.3V, 5V

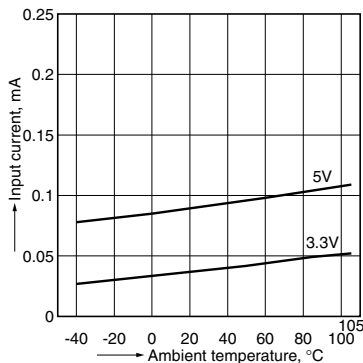

8. Current vs. voltage characteristics of output at MOS portion

Measured portion: between terminals 3 and 4
 Input voltage: 5V
 Ambient temperature: 25°C 77°F

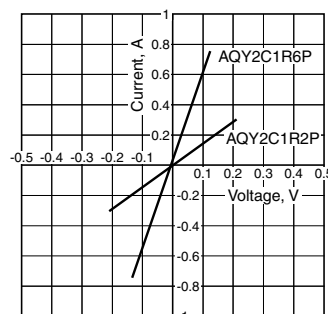

9. Input current vs. input voltage characteristics

Ambient temperature: 25°C 77°F
 (Recommended input voltage: 3 to 5 V)

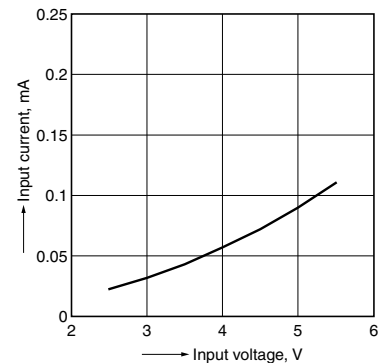

10. Off state leakage current vs. load voltage characteristics

Measured portion: between terminals 3 and 4
Ambient temperature: 25°C 77°F

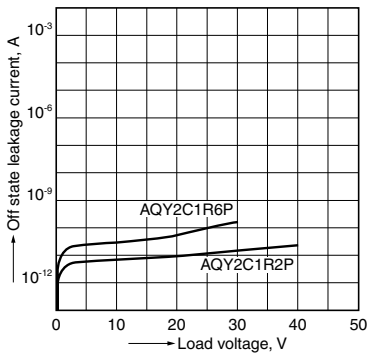

11. Turn on time vs. input voltage characteristics

Measured portion: between terminals 3 and 4,
Load voltage: 10V (DC)
Continuous load current: 100mA (DC)
Ambient temperature: 25°C 77°F

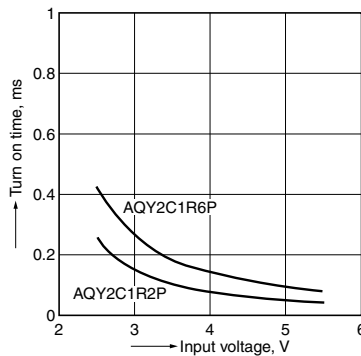

12. Turn off time vs. input voltage characteristics

Measured portion: between terminals 3 and 4,
Load voltage: 10V (DC)
Continuous load current: 100mA (DC)
Ambient temperature: 25°C 77°F

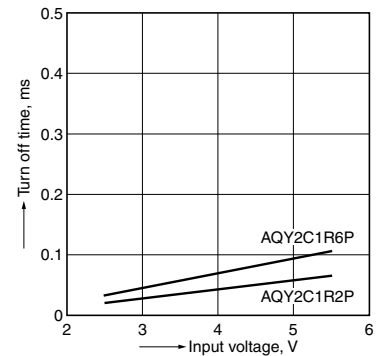

13. Output capacitance vs. applied voltage characteristics

Measured portion: between terminals 3 and 4
Frequency: 1MHz (30mVrms),
Ambient temperature: 25°C 77°F

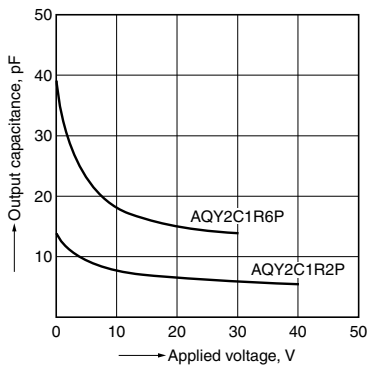

14. Isolation vs. frequency characteristic (50Ω impedance)

Measured portion: between terminals 3 and 4
Ambient temperature: 25°C 77°F

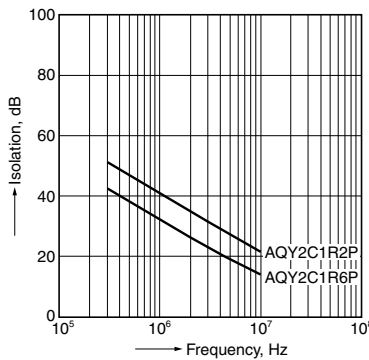

15. Insertion loss vs. frequency characteristic (50Ω impedance)

Measured portion: between terminals 3 and 4,
Input voltage: 5V
Ambient temperature: 25°C 77°F

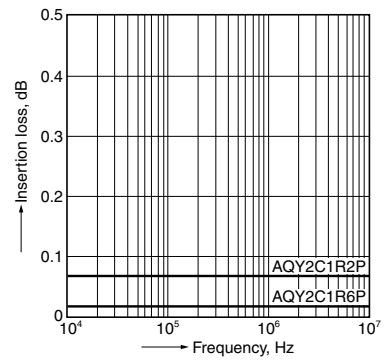

16.-(1) On resistance distribution

Sample: AQY2C1R6P,
Measured portion: between terminals 3 and 4
Input voltage: 5V,
Continuous load current: 750mA (DC)
n: 50 pcs., Ambient temperature: 25°C 77°F

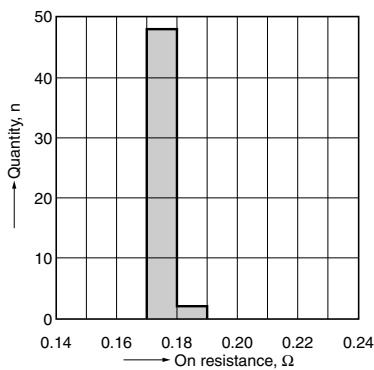

16.-(2) On resistance distribution

Sample: AQY2C1R2P,
Measured portion: between terminals 3 and 4
Input voltage: 5V,
Continuous load current: 300mA (DC)
n: 50 pcs., Ambient temperature: 25°C 77°F

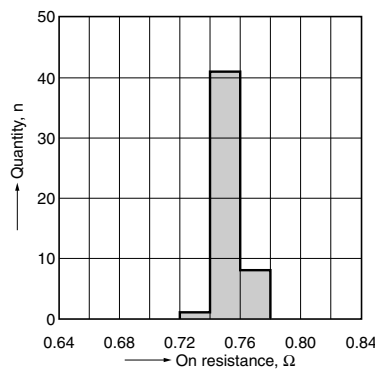

17.-(1) Turn on time distribution

Sample: AQY2C1R6P, Input voltage: 5V
Load voltage: 10V (DC),
Continuous load current: 100mA (DC)
n: 50 pcs., Ambient temperature: 25°C 77°F

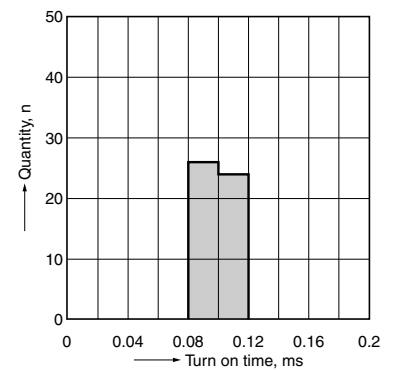

17.-(2) Turn on time distribution

Sample: AQY2C1R2P, Input voltage: 5V
 Load voltage: 10V (DC),
 Continuous load current: 100mA (DC)
 n: 50 pcs., Ambient temperature: 25°C 77°F

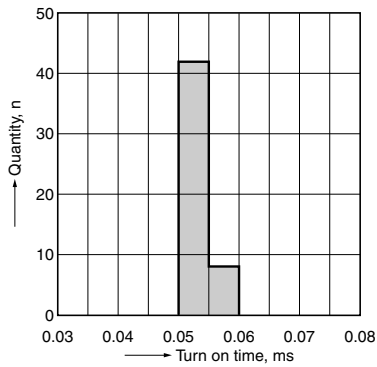

18.-(1) Turn off time distribution

Sample: AQY2C1R6P, Input voltage: 5V
 Load voltage: 10V (DC),
 Continuous load current: 100mA (DC)
 n: 50 pcs., Ambient temperature: 25°C 77°F

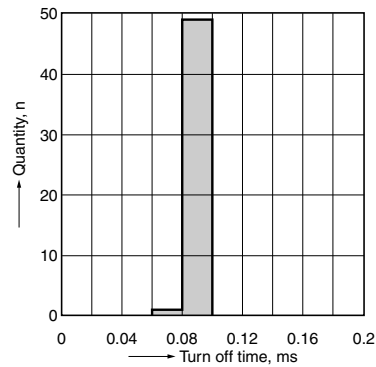

18.-(2) Turn off time distribution

Sample: AQY2C1R2P, Input voltage: 5V
 Load voltage: 10V (DC),
 Continuous load current: 100mA (DC)
 n: 50 pcs., Ambient temperature: 25°C 77°F

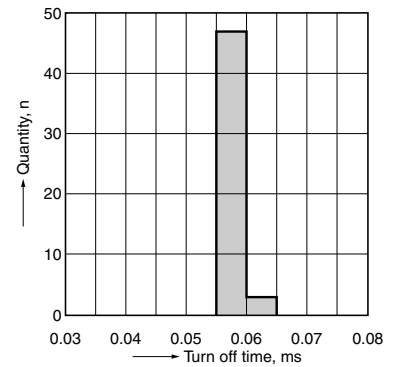

19.-(1) Operate voltage distribution

Sample: AQY2C1R6P, Load voltage: 10V (DC)
 Continuous load current: 100mA (DC)
 n: 50 pcs., Ambient temperature: 25°C 77°F

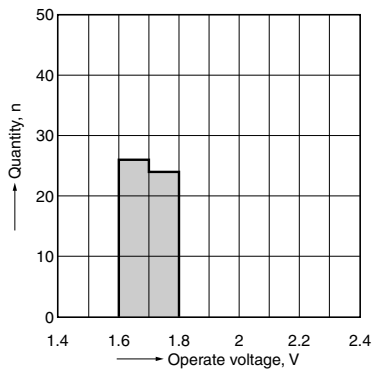

19.-(2) Operate voltage distribution

Sample: AQY2C1R2P, Load voltage: 10V (DC)
 Continuous load current: 300mA (DC)
 n: 50 pcs., Ambient temperature: 25°C 77°F

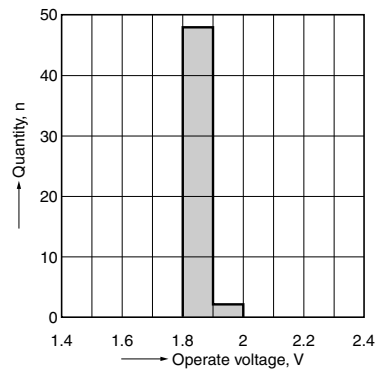

DIMENSIONS (mm inch)

The CAD data of the products with a **CAD Data** mark can be downloaded from: <http://industrial.panasonic.com/ac/e/>

CAD Data

External dimensions

Recommended mounting pad (Top view)

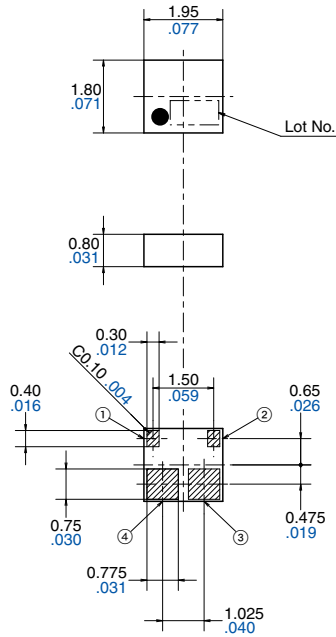

- ① Input: DC+
- ② Input: DC-
- ③ Output: AC/DC
- ④ Output: AC/DC

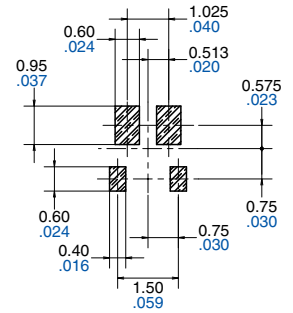

Tolerance: $\pm 0.1 \pm 0.004$

General tolerance: $\pm 0.2 \pm 0.008$

SCHEMATIC AND WIRING DIAGRAMS

V_{IN} : Input voltage, I_{IN} : Input current, V_L : Load voltage, I_L : Load current

Schematic	Output configuration	Load type	Connection	Wiring diagram
	1a	AC/DC	—	

CAUTIONS FOR USE

SAFETY WARNINGS

- Do not use the product under conditions that exceed the range of its specifications. It may cause overheating, smoke, or fire.

- Do not touch the recharging unit while the power is on. There is a danger of electrical shock. Be sure to turn off the power when performing mounting, maintenance, or repair operations on the device (including connecting parts such as the terminal board and socket).

- Check the connection diagrams in the catalog and be sure to connect the terminals correctly. Erroneous connections could lead to unexpected operating errors, overheating, or fire.

1. Derating design

Derating is essential in any reliable design and is a significant factor for product life.

Even if the conditions of use (temperature, current, voltage, etc.) of the product fall within the absolute maximum ratings, reliability can be reduced remarkably when continually used under high load (high temperature, high humidity, high current, high voltage, etc.). Therefore, please derate sufficiently below the absolute maximum rating and verify operation of the actual design before use.

Also, if there is the possibility that the inferior quality of this product could possibly cause great adverse affect on human life or physical property we recommend that, from the perspective of a manufacturer's liability, sufficient amount of derating to be added to the maximum rating value and implement safety measures such as fail-safe circuit.

2. Input voltage

For rising and dropping ratio of input voltage(dv/dt), maintain min. 100mV/ms.

3. Applying stress that exceeds the absolute maximum rating

If the voltage or current value for any of the terminals exceeds the absolute maximum rating, internal elements will deteriorate because of the overvoltage or overcurrent. In extreme cases, wiring may melt, or silicon P/N junctions may be destroyed.

Therefore, the circuit should be designed in such a way that the load never exceed the absolute maximum ratings, even momentarily.

4. Oscillation circuit and control circuit

The oscillation circuit and control circuit of product may be destroyed by external noise, surge, static electricity and so on. For noise effect to peripheral circuits when oscillation circuit operates, please implement safety measures on the system before use by verifying operation under the actual design.

5. Deterioration and destruction caused by discharge of static electricity

This phenomenon is generally called static electricity destruction, and occurs when static electricity generated by various factors is discharged while the PhotoMOS[®] terminals are in contact, producing internal destruction of the element.

To prevent problems from static electricity, the following precautions and measures should be taken when using your device.

- Employees handling PhotOMOS[®] should wear anti-static clothing and should be grounded through protective resistance of 500kΩ to 1MΩ.
- A conductive metal sheet should be placed over the worktable. Measuring instruments and jigs should be grounded.
- When using soldering irons, either use irons with low leakage current, or ground the tip of the soldering iron. (Use of low-voltage soldering irons is also recommended.)
- Devices and equipment used in assembly should also be grounded.

(5) When packing printed circuit boards and equipment, avoid using high-polymer materials such as foam styrene, plastic, and other materials which carry an electrostatic charge.

(6) When storing or transporting PhotoMOS[®], the environment should not be conducive to generating static electricity (for instance, the humidity should be between 45% and 60%), and PhotoMOS[®] should be protected using conductive packing materials.

6. Short across terminals

Do not short circuit between terminals when device is energized, since there is possibility of breaking of the internal IC.

7. Output spike voltages

1) If an inductive load generates spike voltages which exceed the absolute maximum rating, the spike voltage must be limited.

Typical circuits of AC/DC dual use type are shown below.

It is the same with DC only type.

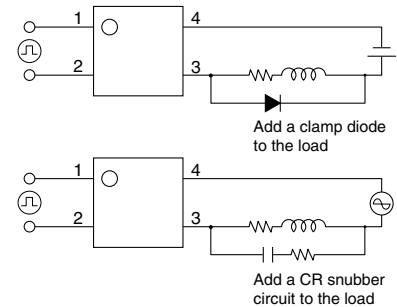

2) Even if spike voltages generated at the load are limited with a clamp diode if the circuit wires are long, spike voltages will occur by inductance. Keep wires as short as possible to minimize inductance.

8. Reverse voltages at the input

If reverse voltages are present at the input terminals, for example, connect a schottky barrier diode in reverse parallel across the input terminals and keep the reverse voltages below the reverse breakdown voltage. Typical circuit is shown below.

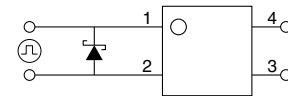

9. Ripple in the input power supply

If ripple is present in the input power supply, observe the following:

- Please maintain the input voltage at least 3V for E_{min} .
- Please make sure the input voltage for E_{max} is no higher than 5.5V.
- Please keep amplitude voltage of ripple within $\pm 0.5V$.

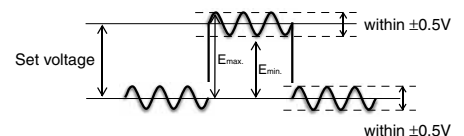

9. Soldering

• When soldering surface-mount terminals, TSON package, the following conditions are recommended.

(1) IR (Infrared reflow) soldering method

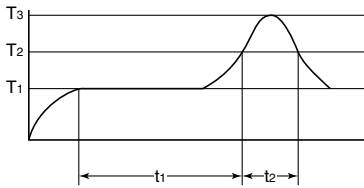

$T_1 = 150 \text{ to } 180^\circ\text{C}$ 302 to 356°F

$T_2 = 230^\circ\text{C}$ 446°F

$T_3 = 245^\circ\text{C}$ 473°F or less

$t_1 = 60 \text{ to } 120 \text{ s}$ or less

$t_2 = 30 \text{ s}$ or less

(2) Soldering iron method

Tip temperature: 350 to 400°C 662 to 752°F

Wattage: 30 to 60 W

Soldering time: within 3 s

(3) Others

Check mounting conditions before using other soldering methods (DWS, VPS, hot-air, hot plate, laser, pulse heater, etc.)

- When using lead-free solder, we recommend a type with an alloy composition of Sn 3.0 Ag 0.5 Cu. Please inquire about soldering conditions and other details.
- The temperature profile indicates the temperature of the soldered terminal on the surface of the PC board. The ambient temperature may increase excessively. Check the temperature under mounting conditions.

10. Notes for mounting

- 1) If many different packages are combined on a single substrate, then lead temperature rise is highly dependent on package size. For this reason, please make sure that the temperature of the terminal solder area of the PhotoMOS® falls within the temperature conditions of item "9. Soldering" before mounting.
- 2) If the mounting conditions exceed the recommended solder conditions in item "9. Soldering", resin strength will fall and the nonconformity of the heat expansion coefficient of each constituent material will increase markedly, possibly causing cracks in the package, severed bonding wires, and the like. For this reason, please inquire with us about whether this use is possible.

11. Cleaning solvents compatibility

We recommend cleaning with an organic solvent. If you cannot avoid using ultrasonic cleansing, please ensure that the following conditions are met, and check beforehand for defects.

- Frequency: 27 to 29 kHz
- Ultrasonic output: No greater than 0.25W/cm²
- Cleaning time: No longer than 30 s
- Cleanser used: Asahiklin AK-225
- Other: Submerge in solvent in order to prevent the PCB and elements from being contacted directly by the ultrasonic vibrations.

Note: Applies to unit area ultrasonic output for ultrasonic baths.

12. Transportation and storage

- 1) Extreme vibration during transport will damage the PhotoMOS®. Handle the outer and inner boxes with care.
- 2) Storage under extreme conditions will cause soldering degradation, external appearance defects, and deterioration of the characteristics. The following storage conditions are recommended:
 - Temperature: 0 to 45°C 32 to 113°F
 - Humidity: Less than 70%R.H.
 - Atmosphere: No harmful gasses such as sulfurous acid gas, minimal dust.
- 3) This PhotoMOS® implemented in TSON is sensitive to moisture and come in sealed moisture-proof package. Observe the following cautions on storage.
 - After the moisture-proof package is unsealed, take the devices out of storage as soon as possible (within 1 month at the most $\leq 45^\circ\text{C}$ 113°F/70%R.H.).
 - If the devices are to be left in storage for a considerable period after the moisture-proof package has been unsealed, it is recommended to keep them in another moisture-proof bag containing silica gel (within 3 months at the most).

CC TSON C×R (AQY2)

13. Packaging format

1) Tape and reel (Unit: mm inch)

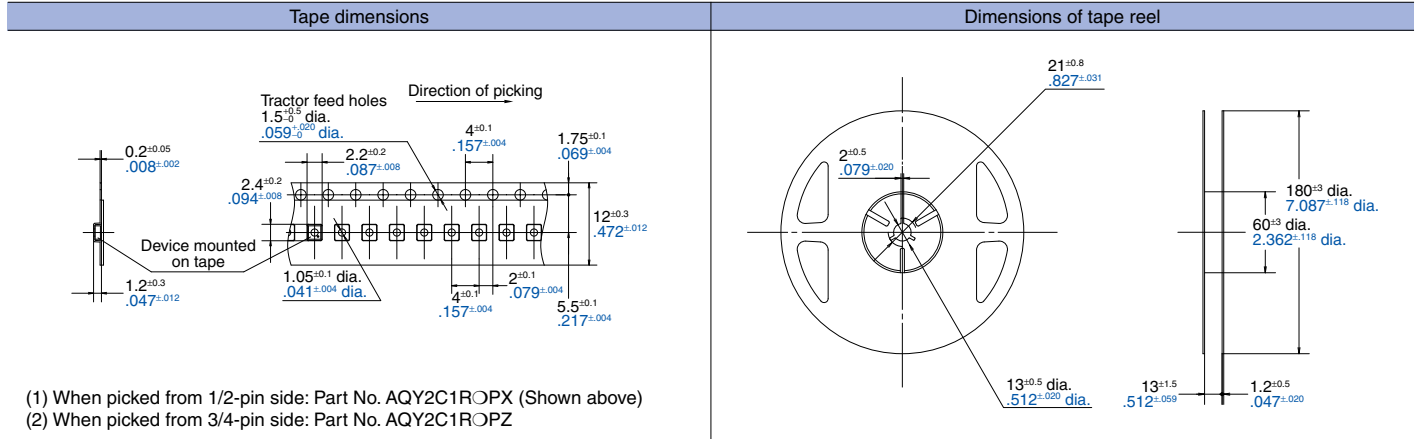

"PhotoMOS", "PhotoMOS" and "PHOTOMOS" are registered trademarks of Panasonic Corporation.
 *Recognized in Japan, the United States, all member states of European Union and other countries.

Please contact

Panasonic Corporation

Electromechanical Control Business Division

■ 1048, Kadoma, Kadoma-shi, Osaka 571-8686, Japan
industrial.panasonic.com/ac/e/

Panasonic®

©Panasonic Corporation 2015