



Chipsmall Limited consists of a professional team with an average of over 10 year of expertise in the distribution of electronic components. Based in Hongkong, we have already established firm and mutual-benefit business relationships with customers from,Europe,America and south Asia,supplying obsolete and hard-to-find components to meet their specific needs.

With the principle of “Quality Parts,Customers Priority,Honest Operation,and Considerate Service”,our business mainly focus on the distribution of electronic components. Line cards we deal with include Microchip,ALPS,ROHM,Xilinx,Pulse,ON,Everlight and Freescale. Main products comprise IC,Modules,Potentiometer,IC Socket,Relay,Connector.Our parts cover such applications as commercial,industrial, and automotives areas.

We are looking forward to setting up business relationship with you and hope to provide you with the best service and solution. Let us make a better world for our industry!



Contact us

Tel: +86-755-8981 8866 Fax: +86-755-8427 6832

Email & Skype: info@chipsmall.com Web: www.chipsmall.com

Address: A1208, Overseas Decoration Building, #122 Zhenhua RD., Futian, Shenzhen, China



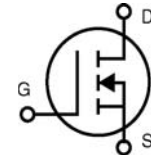
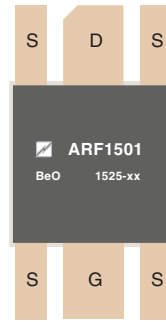

RF POWER MOSFET N-CHANNEL ENHANCEMENT MODE

250V 750W 40MHz

The ARF1501 is an RF power transistor designed for very high power scientific, commercial, medical and industrial RF power generator and amplifier applications up to 40 MHz.

- **Specified 250 Volt, 27.12 MHz Characteristics:**
 - Output Power = 750 Watts.**
 - Gain = 17dB (Class C)**
 - Efficiency > 75%**
- **High Performance Power RF Package.**
- **Very High Breakdown for Improved Ruggedness.**
- **Low Thermal Resistance.**
- **Nitride Passivated Die for Improved Reliability.**

MAXIMUM RATINGS

 All Ratings: $T_C = 25^\circ\text{C}$ unless otherwise specified.

Symbol	Parameter	ARF1501	UNIT
V_{DSS}	Drain-Source Voltage	1000	Volts
I_D	Continuous Drain Current @ $T_C = 25^\circ\text{C}$	30	Amps
V_{GS}	Gate-Source Voltage	± 30	Volts
P_D	Total Device Dissipation @ $T_C = 25^\circ\text{C}$	1500	Watts
T_J, T_{STG}	Operating and Storage Junction Temperature Range	-55 to 175	°C
T_L	Lead Temperature: 0.063" from Case for 10 Sec.	300	

STATIC ELECTRICAL CHARACTERISTICS

Symbol	Characteristic / Test Conditions	MIN	TYP	MAX	UNIT
BV_{DSS}	Drain-Source Breakdown Voltage ($V_{GS} = 0V, I_D = 250 \mu\text{A}$)	1000			Volts
$V_{DS(ON)}$	On State Drain Voltage ^① ($I_{D(ON)} = 15A, V_{GS} = 10V$)		7.5	9	
I_{DSS}	Zero Gate Voltage Drain Current ($V_{DS} = 1000V, V_{GS} = 0V$)			40	μA
	Zero Gate Voltage Drain Current ($V_{DS} = 800V, V_{GS} = 0V, T_C = 125^\circ\text{C}$)			1000	
I_{GSS}	Gate-Source Leakage Current ($V_{GS} = \pm 30V, V_{DS} = 0V$)			± 400	nA
g_{fs}	Forward Transconductance ($V_{DS} = 25V, I_D = 15A$)	5.5	7		mhos
$V_{isolation}$	RMS Voltage (60Hz Sinewave from terminals to mounting surface for 1 minute)	TBD			Volts
$V_{GS(TH)}$	Gate Threshold Voltage ($V_{DS} = V_{GS}, I_D = 50mA$)	3		5	Volts

THERMAL CHARACTERISTICS

Symbol	Characteristic (per package unless otherwise noted)	MIN	TYP	MAX	UNIT
$R_{\theta JC}$	Junction to Case			0.10	°C/W
$R_{\theta JHS}$	Junction to Sink (Use High Efficiency Thermal Joint Compound and Planar Heat Sink Surface.)		0.16		

 CAUTION: These Devices are Sensitive to Electrostatic Discharge. Proper Handling Procedures Should Be Followed.

Symbol	Characteristic	Test Conditions	MIN	TYP	MAX	UNIT
C_{iss}	Input Capacitance	$V_{GS} = 0V$ $V_{DS} = 200V$ $f = 1\text{ MHz}$		5400	6500	pF
C_{oss}	Output Capacitance			300	400	
C_{rss}	Reverse Transfer Capacitance			125	160	
$t_{d(on)}$	Turn-on Delay Time	$V_{GS} = 15V$ $V_{DD} = 500V$ $I_D = I_{D[Cont.]} @ 25^\circ C$ $R_G = 1.6\ \Omega$		8		ns
t_r	Rise Time			5		
$t_{d(off)}$	Turn-off Delay Time			25		
t_f	Fall Time			13		

FUNCTIONAL CHARACTERISTICS

Symbol	Characteristic	Test Conditions	MIN	TYP	MAX	UNIT
G_{PS}	Common Source Amplifier Power Gain	$f = 27.12\text{ MHz}$	15	17		dB
η	Drain Efficiency	$V_{GS} = 0V$ $V_{DD} = 250V$	70	75		%
Ψ	Electrical Ruggedness VSWR 10:1	$P_{out} = 750W$	No Degradation in Output Power			

① Pulse Test: Pulse width < 380 μ S, Duty Cycle < 2%.

Microsemi reserves the right to change, without notice, the specifications and information contained herein.

Per transistor section unless otherwise specified.

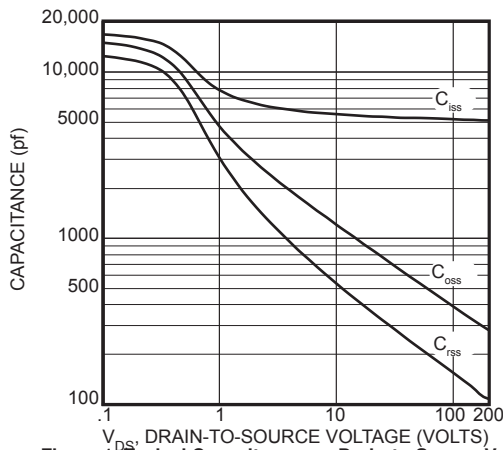

Figure 1, Typical Capacitance vs. Drain-to-Source Voltage

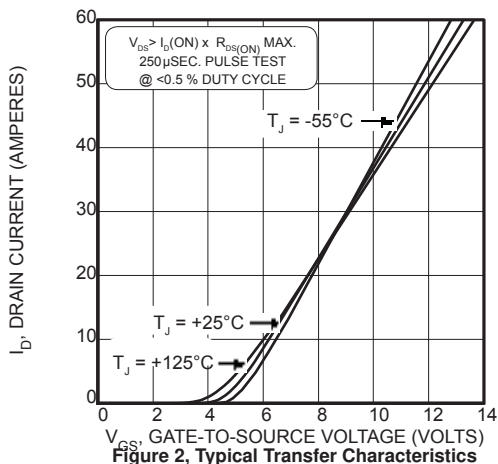

Figure 2, Typical Transfer Characteristics

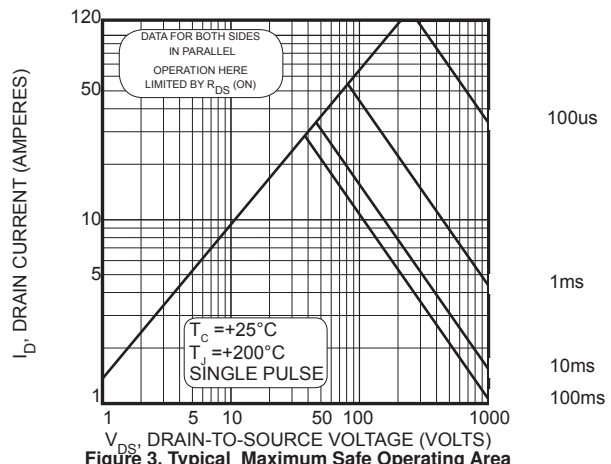

Figure 3, Typical Maximum Safe Operating Area

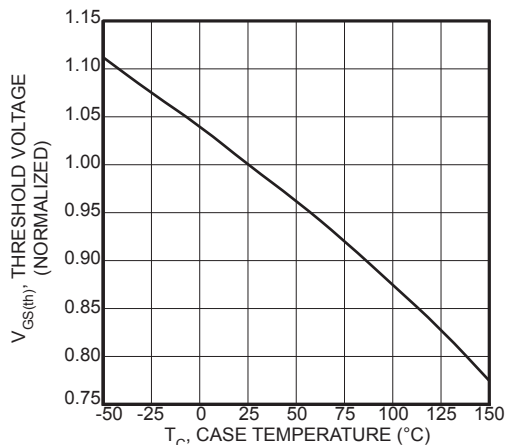

Figure 4, Typical Threshold Voltage vs Temperature

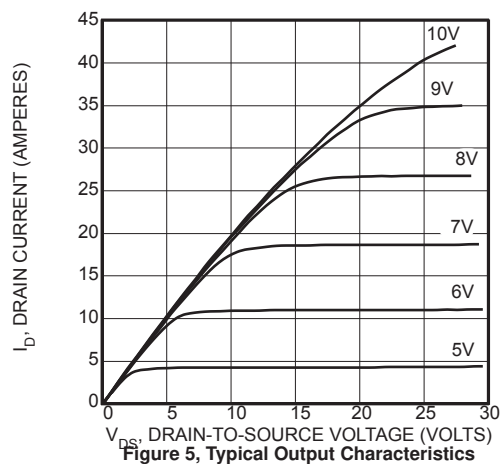

Figure 5, Typical Output Characteristics

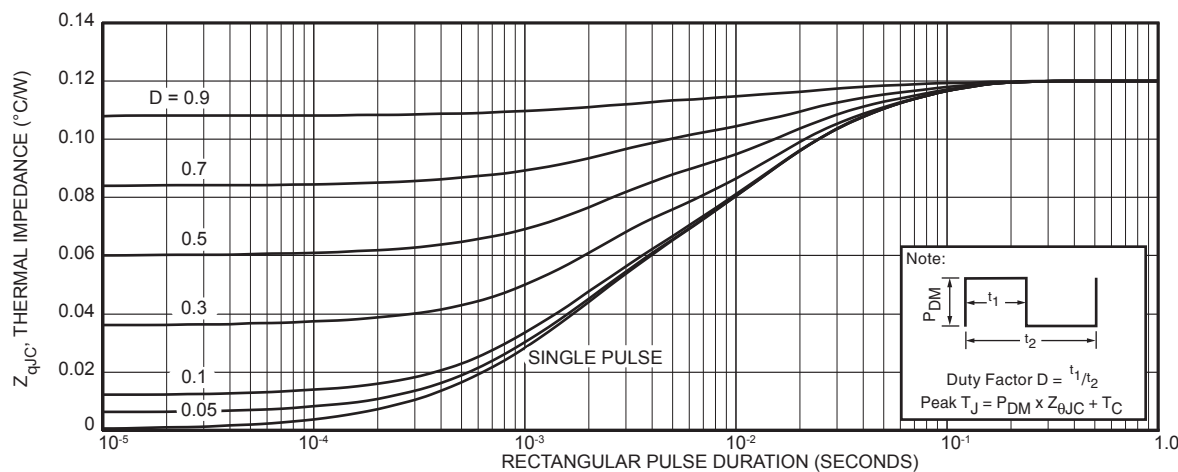

Figure 6, Maximum Effective Transient Thermal Impedance, Junction-to-Case vs. Pulse Duration

Table 1 - Typical Class AB Large Signal Impedance -- ARF1501

F (MHz)	Z _{in} (Ω)	Z _{OL} (Ω)
2.0	10.6 -j 12.2	31 -j 4.7
13.5	0.5 -j 2.7	15.6 -j 16
27	0.22 -j 0.8	6.2 -j 12.6
40	0.2 +j .12	3.1 -j 9.4

Z_{in} - Gate shunted with 25Ω I_{DQ} = 100mA
 Z_{OL} - Conjugate of optimum load for 750 Watts output at V_{dd} = 250V

Thermal Considerations and Package Mounting:

The rated 1500W power dissipation is only available when the package mounting surface is at 25°C and the junction temperature is 200°C. The thermal resistance between junctions and case mounting surface is 0.12°C/W. When installed, an additional thermal impedance of 0.1°C/W between the package base and the mounting surface is typical. Insure that the mounting surface is smooth and flat. Thermal joint compound must be used to reduce the effects of small surface irregularities. The heatsink should incorporate a copper heat spreader to obtain best results.

The package is designed to be clamped to a heatsink. A clamped joint maintains the required mounting pressure while allowing for thermal expansion of both the device and the heat sink. A simple clamp, and two 6-32 (M3.5) screws can provide the minimum 125lb required mounting force. T = 12 in-lb.

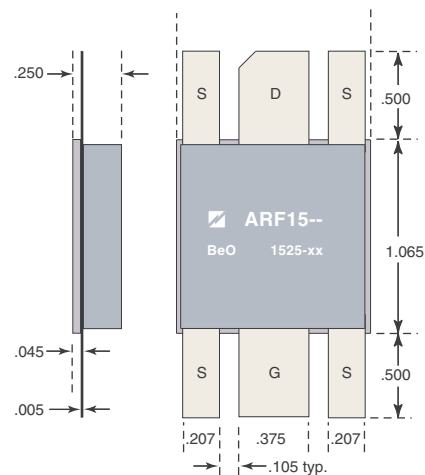
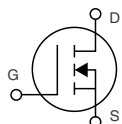
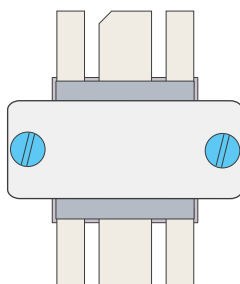
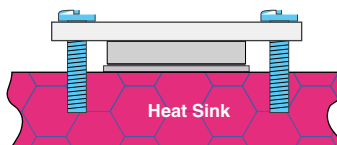

HAZARDOUS MATERIAL WARNING

The ceramic portion of the device between leads and mounting surface is beryllium oxide, BeO. Beryllium oxide dust is toxic when inhaled. Care must be taken during handling and mounting to avoid damage to this area. These devices must never be thrown away with general industrial or domestic waste.

ARF1501 -- 27.12 MHz Test Circuit

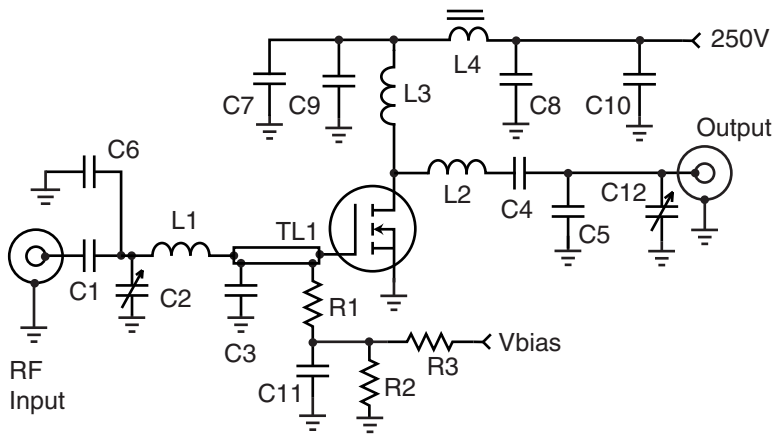

- C1, C7, C8, C11 .1uF 250V ceramic chip
- C2, C12 ARCO 465 75-380pF mica trimmer
- C3 4700pF ATC700B
- C4, C9-C11 8200pF 500V NPO ceramic
- C5 - C6 150pF ATC 700B
- L1 90 nH 4t #18 0.25"d .25"l
- L2 175 nH - 3t #10 .75" dia .75" l
- L3 2uH - 22t #24 enam. .312" dia.
- L4 500nH 2t on 850u .5" bead
- R1-R3 1k Ω 1/4W
- TL1 .112" x 1.2" (50 Ω) Stripline

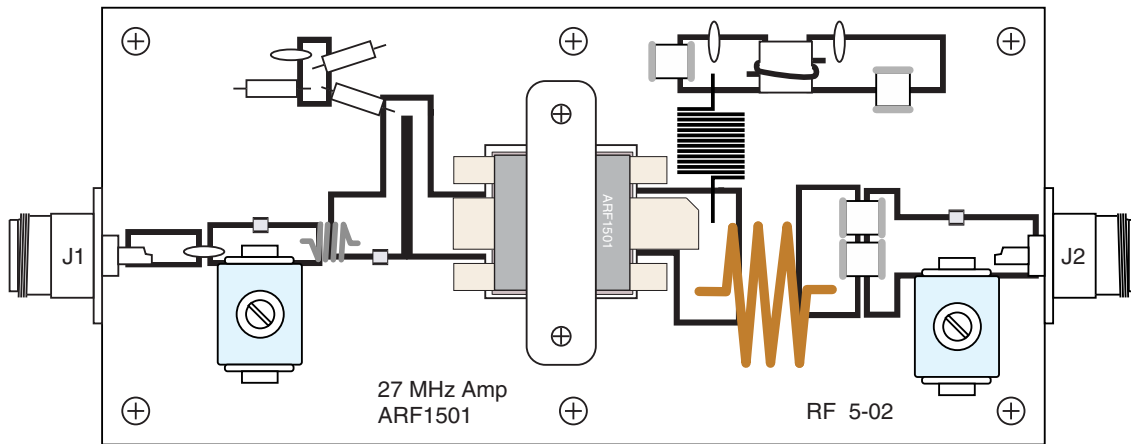

Parts placement

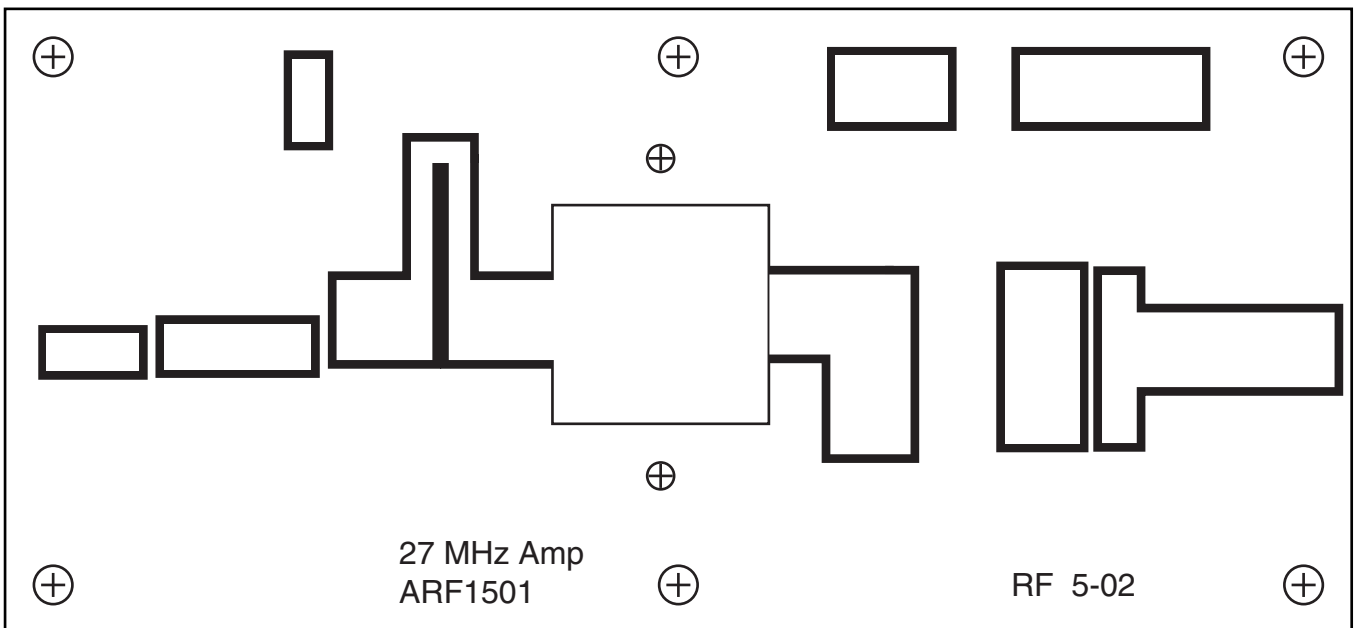

1:1 pcb artwork