



Chipsmall Limited consists of a professional team with an average of over 10 year of expertise in the distribution of electronic components. Based in Hongkong, we have already established firm and mutual-benefit business relationships with customers from,Europe,America and south Asia,supplying obsolete and hard-to-find components to meet their specific needs.

With the principle of "Quality Parts,Customers Priority,Honest Operation,and Considerate Service",our business mainly focus on the distribution of electronic components. Line cards we deal with include Microchip,ALPS,ROHM,Xilinx,Pulse,ON,Everlight and Freescale. Main products comprise IC,Modules,Potentiometer,IC Socket,Relay,Connector.Our parts cover such applications as commercial,industrial, and automotives areas.

We are looking forward to setting up business relationship with you and hope to provide you with the best service and solution. Let us make a better world for our industry!



Contact us

Tel: +86-755-8981 8866 Fax: +86-755-8427 6832

Email & Skype: info@chipsmall.com Web: www.chipsmall.com

Address: A1208, Overseas Decoration Building, #122 Zhenhua RD., Futian, Shenzhen, China



RJ45 10/100/1000 Base-T Jack with Magnetic Module

ARJ11C

RoHS
Compliant



16.00 x 13.6 x 21.5mm/
16.50 x 13.85 x 26.65 mm

FEATURES:

- Excellent EMI suppression
- Meet IEEE 802.3 standards and FCC mechanical requirements
- Low Cost, RoHS Compliant Reflow-able device

APPLICATIONS:

- LAN-on-Motherboard (LOM)
- SOHO (ADSL modems), Hubs.
- Suitable for CAT 5 & 6 Fast Ethernet Cable or better UTP

STANDARD SPECIFICATIONS at 25°C

Operating Temperature: - 0°C to + 70°C
Storage Temperature: - 40°C to +85°C

Operating life: 750 Cycles min.

Part Number	Turns Ratio		EMI Fingers	LED (L/R)	Insertion Loss (dB max)	Return Loss (dB min @100Ω±15Ω)			
	TX	RX				0.3-100 MHz	1- 30 MHz	40 MHz	50 MHz
ARJ11C-MBSAS-A-BA-□ MU2	1CT:1CT	1CT:1CT	Yes	G/YG	-1.2	-16	-13.5	-11.5	-10
ARJ11C-MBSAT-A-B-□ MU2	1CT:1CT	1CT:1CT	Yes	G/Y	-1.2	-16	-13.5	-11.5	-10
ARJ11C-MBSAS-A-B-□ MU2	1CT:1CT	1CT:1CT	Yes	G/Y	-1.2	-16	-13.5	-11.5	-10
ARJ11C-MBSAU- A-B-□ MU2	1CT:1CT	1CT:1CT	Yes	G/Y	-1.2	-16	-13.5	-11.5	-10
ARJ11C-MCSAT- A-B-□ MU2	1CT:1CT	1CT:1CT	Yes	G/Y	-1.1	-15	-15	-15	-12
ARJ11C-MASAA- B-A-□ LU2	1CT:1	1CT:1CT	Yes	Y/G	-1.2	-14	-14	-14	-10
ARJ11C-MASAB- B-A-□ MU2	1CT:1CT	1CT:1CT	Yes	Y/G	-1.2	-14	-14	-14	-10
ARJ11C-MASAD- A-A-□ MU2	1CT:1CT	1CT:1CT	Yes	G/G	-1.2	-14	-14	-14	-10

Part Number	Crosstalk (dB min)			DCMR (dB min)			Hipot (Vrms)
	30 MHz	60 MHz	100 MHz	30 MHz	60 MHz	100 MHz	
ARJ11C-MBSAS-A-BA-□ MU2	-40	-36	-30	-35	-32	-30	1500
ARJ11C-MBSAT-A-B-□ MU2	-40	-36	-30	-35	-32	-30	1500
ARJ11C-MBSAS-A-B-□ MU2	-40	-36	-30	-35	-32	-30	1500
ARJ11C-MBSAU- A-B-□ MU2	-40	-36	-30	-35	-32	-30	1500
ARJ11C-MCSAT- A-B-□ MU2	-35	-26	-24	-35	-32	-30	1500
ARJ11C-MASAA- B-A-□ LU2	-40	-36	-30	-35	-32	-30	1500
ARJ11C-MASAB- B-A-□ MU2	-40	-36	-30	-35	-32	-30	1500
ARJ11C-MASAD- A-A-□ MU2	-40	-36	-30	-35	-32	-30	1500

DCMR: Differential to Common Mode Rejection

Contact Abracon for more custom configurations. See options to build a custom configuration.

□ : LED Polarity Option

ARJ11C-MA: 1 or 2
ARJ11C-MBSAS: 7
ARJ11C-MB: 3 or 4
ARJ11C-MC: 5 or 6

Contact Abracon for more custom configurations. See options to build a custom configuration.



RJ45 10/100/1000 Base-T Jack with Magnetic Module

ARJ11C

RoHS
Compliant



16.00 x 13.6 x 21.5mm/
16.50 x 13.85 x 26.65 mm

OPTIONS & PART IDENTIFICATION:

ARJ11C - - - - - - - -

Mechanical	Schematic	Left LED color (e.g. B for Yellow, AB for Green-Yellow)	Right LED color (e.g. B for Yellow, AB for Green-Yellow)	LED polarity	Turns Ratio (Tx)	Turns Ratio (Rx)	Gold plating
MA ~ MC (Please see mechanical section)	SAA ~ SCB (Please see schematic section)	Blank: No LED A: Green B: Yellow C: Amber D: Orange	Blank: No LED A: Green B: Yellow C: Amber D: Orange	Blank: No LED 1 ~ 7 (Please see 7.0 LED polarity section)	K: 1CT:1.41 L: 1CT:1 M: 1CT:1CT N: 1.414:1CT O: 1CT:1.41CT P: 1:2CT Q: 1:1.414CT R: 1CT:2.5	S: 1CT:1.41 T: 1CT:1 U: 1CT:1CT V: 1.414:1CT W: 1CT:1.41CT X: 1:2CT Y: 1:1.414CT Z: 1CT:2.5	1: 3u “ 2: 6u “ 3: 15u “ 4: 30u “ 5: 50u “

OUTLINE DIMENSION:

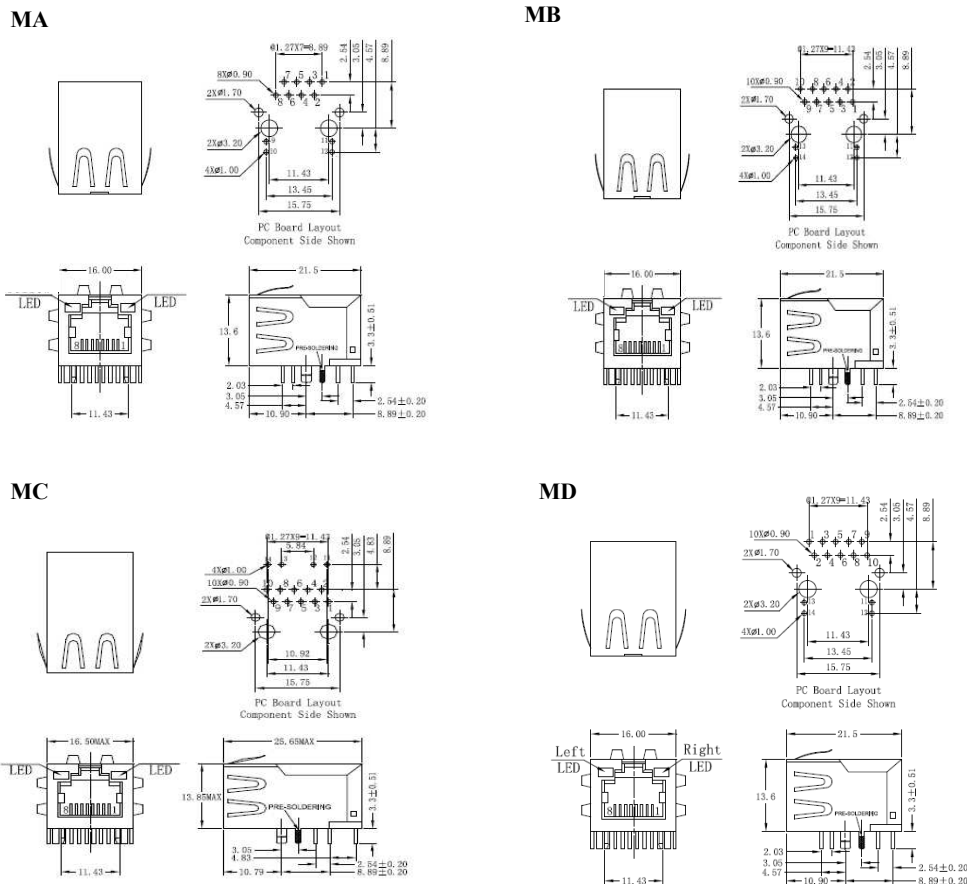

Dimension: mm. All tolerances are ± 0.25

ABRACON IS
ISO 9001:2008
CERTIFIED



ABRACON
CORPORATION

Visit www.abracon.com for Terms & Conditions of Sale
30332 Esperanza, Rancho Santa Margarita, California 92688
tel 949-546-8000 | fax 949-546-8001 | www.abracon.com

Revised: 11.27.13

RJ45 10/100/1000 Base-T Jack with Magnetic Module

ARJ11C

RoHS
Compliant



16.00 x 13.6 x 21.5mm/
16.50 x 13.85 x 26.65 mm

SCHEMATICS

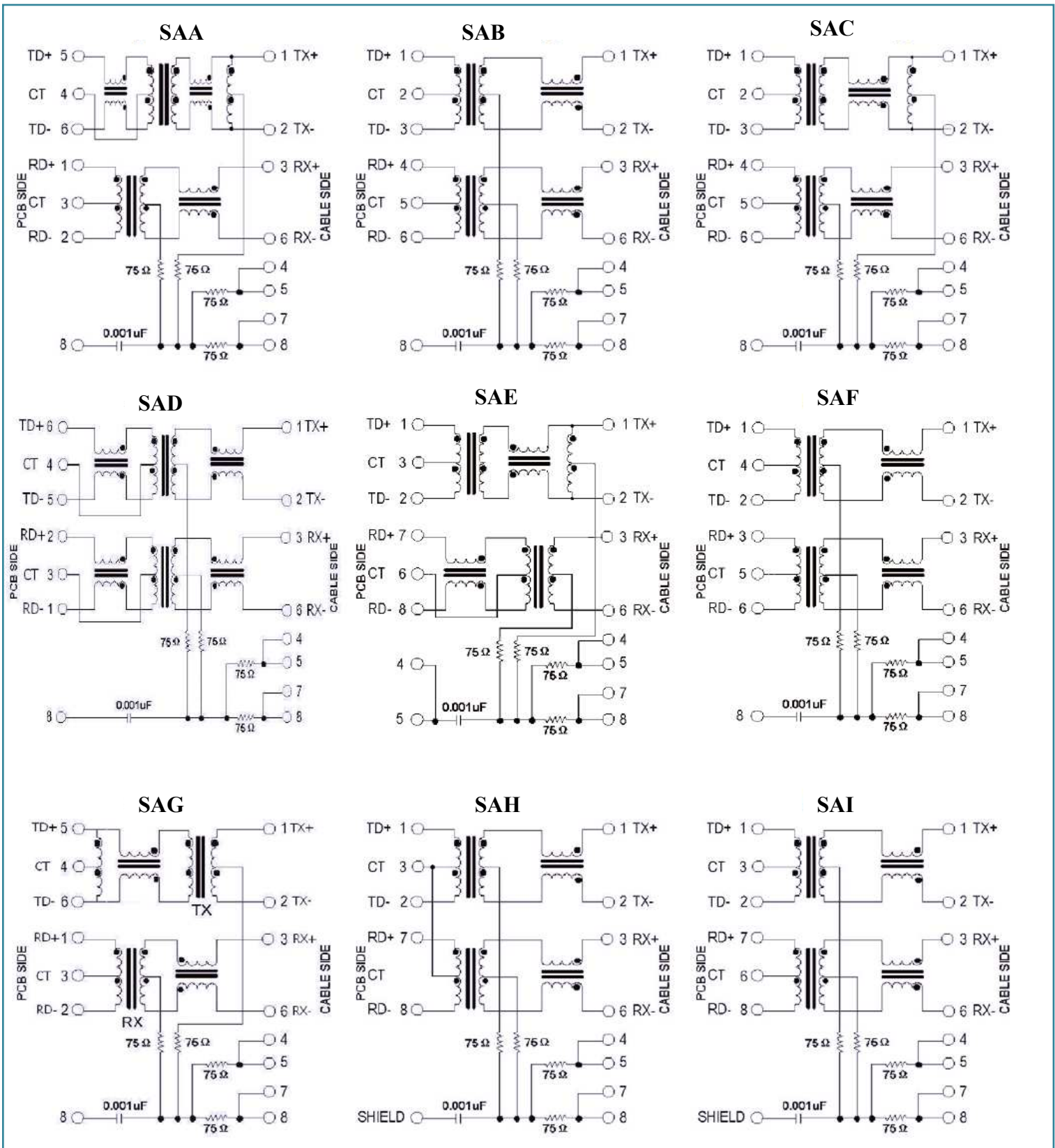

ABRACON IS
ISO 9001:2008
CERTIFIED



ABRACON
CORPORATION

Visit www.abracon.com for Terms & Conditions of Sale
30332 Esperanza, Rancho Santa Margarita, California 92688
tel 949-546-8000 | fax 949-546-8001 | www.abracon.com

Revised: 11.27.13

RJ45 10/100/1000 Base-T Jack with Magnetic Module

ARJ11C

RoHS
Compliant



16.00 x 13.6 x 21.5mm/
16.50 x 13.85 x 26.65 mm

SCHEMATICS

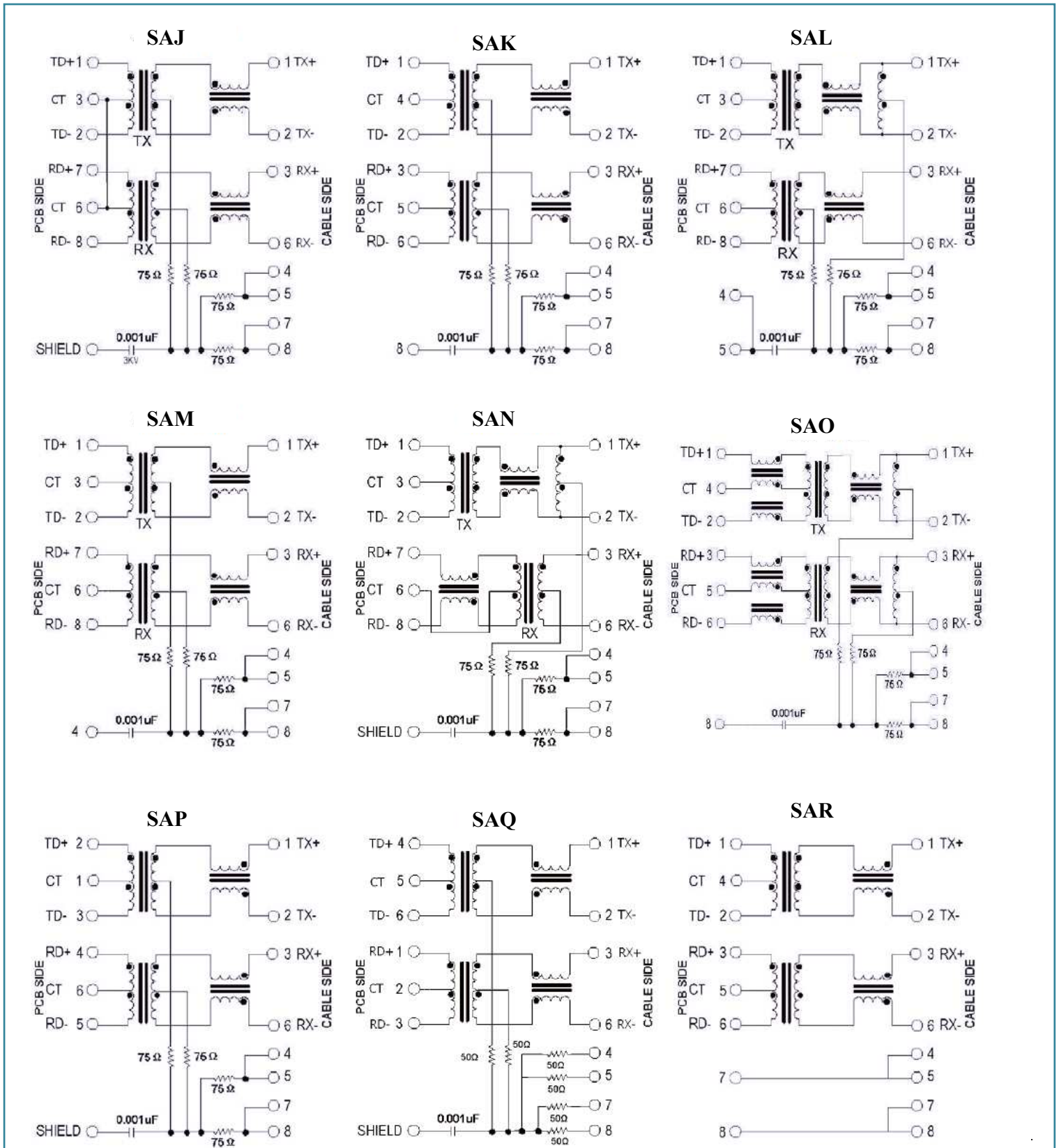

ABRACON IS
ISO 9001:2008
CERTIFIED

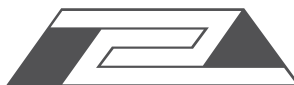

ABRACON
CORPORATION

Visit www.abracon.com for Terms & Conditions of Sale
30332 Esperanza, Rancho Santa Margarita, California 92688
tel 949-546-8000 | fax 949-546-8001 | www.abracon.com

Revised: 11.27.13

RJ45 10/100/1000 Base-T Jack with Magnetic Module

ARJ11C

RoHS
Compliant



16.00 x 13.6 x 21.5mm/
16.50 x 13.85 x 26.65 mm

SCHEMATICS

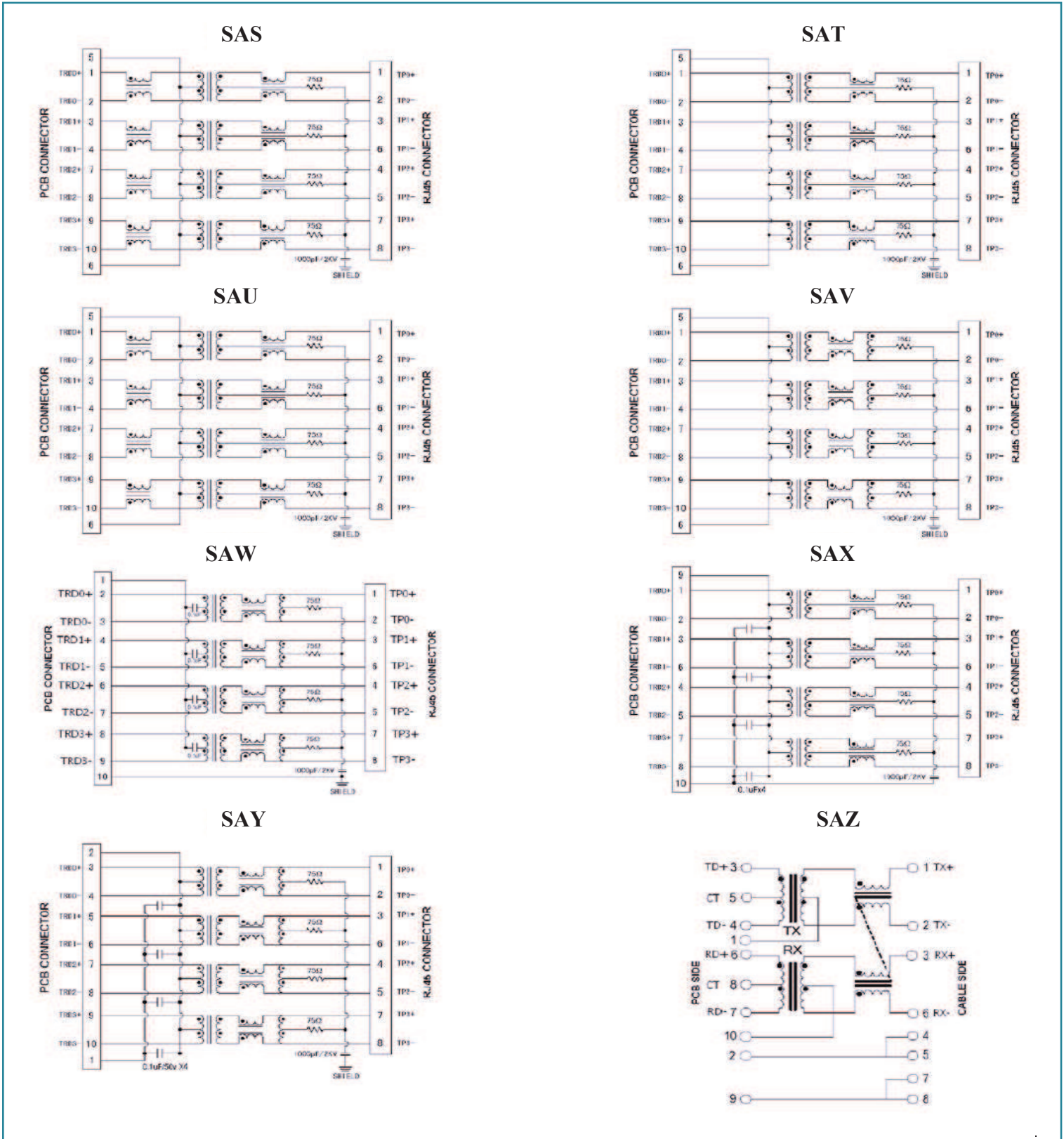

ABRACON IS
ISO 9001:2008
CERTIFIED

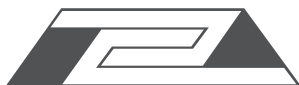

ABRACON
CORPORATION

Visit www.abracon.com for Terms & Conditions of Sale
30332 Esperanza, Rancho Santa Margarita, California 92688
tel 949-546-8000 | fax 949-546-8001 | www.abracon.com

Revised: 11.27.13

RJ45 10/100/1000 Base-T Jack with Magnetic Module

ARJ11C

RoHS
Compliant



16.00 x 13.6 x 21.5mm/
16.50 x 13.85 x 26.65 mm

SCHEMATICS

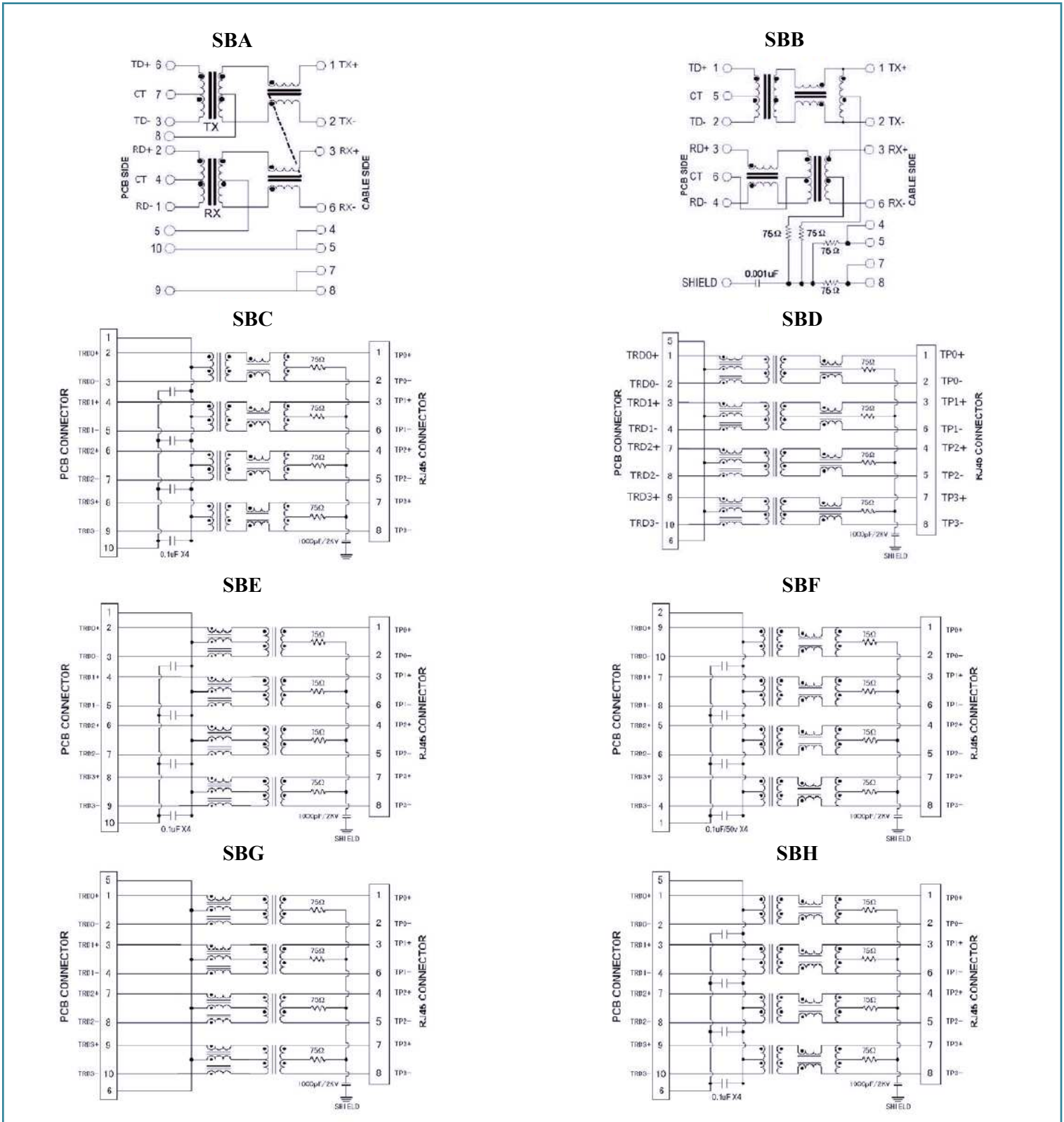

ABRACON IS
ISO 9001:2008
CERTIFIED



ABRACON
CORPORATION

Visit www.abracon.com for Terms & Conditions of Sale
30332 Esperanza, Rancho Santa Margarita, California 92688
tel 949-546-8000 | fax 949-546-8001 | www.abracon.com

Revised: 11.27.13

RJ45 10/100/1000 Base-T Jack with Magnetic Module

ARJ11C

RoHS
Compliant



LED POLARITY

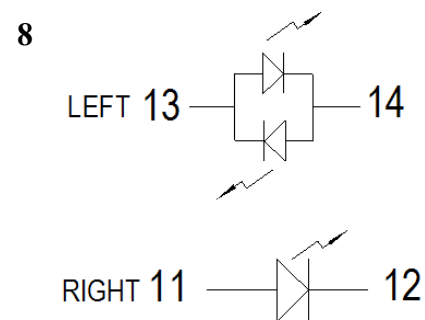
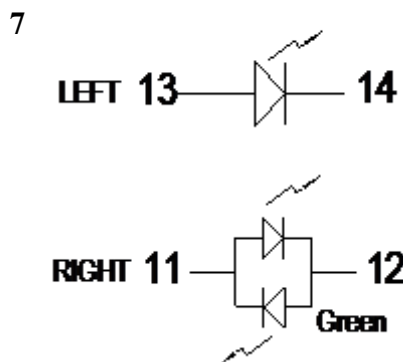
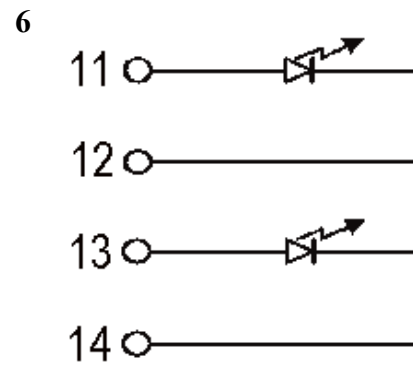
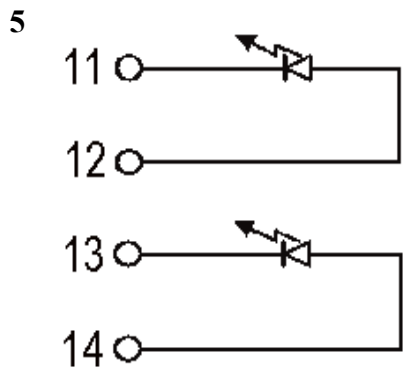
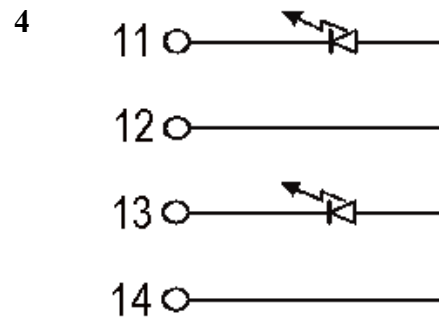
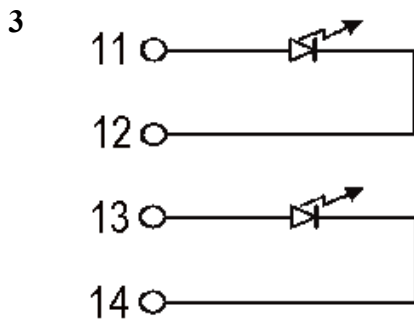
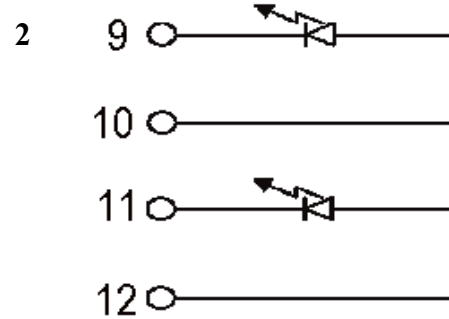
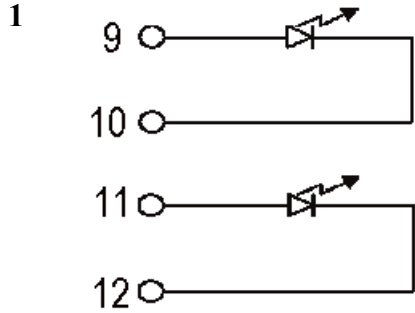

RJ45 10/100/1000 Base-T Jack with Magnetic Module

ARJ11C

RoHS
Compliant



16.00 x 13.6 x 21.5mm/
16.50 x 13.85 x 26.65 mm

REFLOW PROFILE

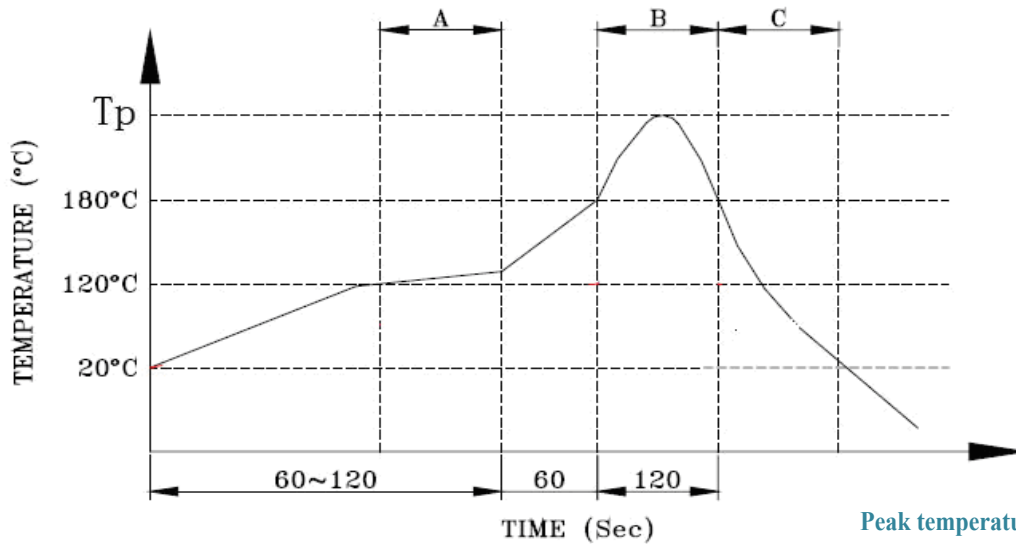

A. Preheating B. Soldering C. Gradual Cooling

TAPE & REEL:

Packing 60pcs/tray
Packaging material: PET

Outer carton unit 1320 pcs/ 22 Trays/box

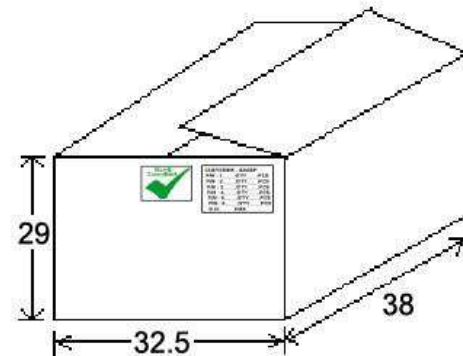
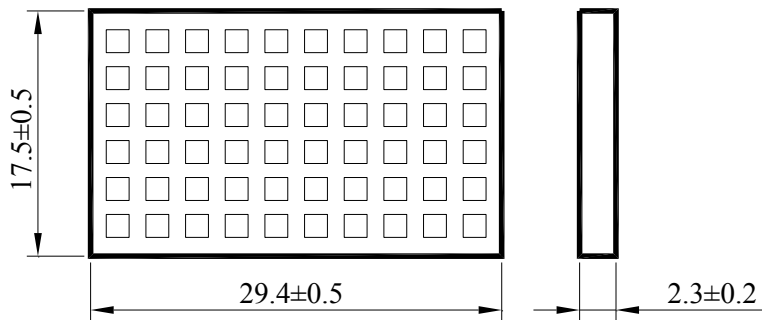

Dimensions: cm

ATTENTION: Abracon Corporation's products are COTS – Commercial-Off-The-Shelf products; suitable for Commercial, Industrial and, where designated, Automotive Applications. Abracon's products are not specifically designed for Military, Aviation, Aerospace, Life-dependant Medical applications or any application requiring high reliability where component failure could result in loss of life and/or property. For applications requiring high reliability and/or presenting an extreme operating environment, written consent and authorization from Abracon Corporation is required. Please contact Abracon Corporation for more information.

ABRACON IS
ISO 9001:2008
CERTIFIED



Visit www.abracon.com for Terms & Conditions of Sale
30332 Esperanza, Rancho Santa Margarita, California 92688
tel 949-546-8000 | fax 949-546-8001 | www.abracon.com

Revised: 11.27.13