



Chipsmall Limited consists of a professional team with an average of over 10 year of expertise in the distribution of electronic components. Based in Hongkong, we have already established firm and mutual-benefit business relationships with customers from,Europe,America and south Asia,supplying obsolete and hard-to-find components to meet their specific needs.

With the principle of “Quality Parts,Customers Priority,Honest Operation,and Considerate Service”,our business mainly focus on the distribution of electronic components. Line cards we deal with include Microchip,ALPS,ROHM,Xilinx,Pulse,ON,Everlight and Freescale. Main products comprise IC,Modules,Potentiometer,IC Socket,Relay,Connector.Our parts cover such applications as commercial,industrial, and automotives areas.

We are looking forward to setting up business relationship with you and hope to provide you with the best service and solution. Let us make a better world for our industry!



## Contact us

Tel: +86-755-8981 8866 Fax: +86-755-8427 6832

Email & Skype: info@chipsmall.com Web: www.chipsmall.com

Address: A1208, Overseas Decoration Building, #122 Zhenhua RD., Futian, Shenzhen, China



# RJ45 10/100/1000 Base-T Jack with Magnetic Module



16.26 x 13.84 x 21.59mm

**RoHS**  
Compliant

**ARJ11F**

## FEATURES:

- Available with or without LED
- Suitable CAT 5 & 6 cable and UTP
- Comply IEEE 802.3ab
- LAN Magnetic with RJ4
- Suitable for RoHS compliant reflow

## APPLICATIONS:

- 10/100/1000 base-T LAN
- NIC, LoM and PC

## STANDARD SPECIFICATIONS at 25°C

**Operating temperature range: 0°C to +70°C    Storage temperature range: -40°C to +85°C**

Part Number	Turns Ratio ± 5%	EMI Fingers	LEDs	Insertion Loss (dB max)	Return Loss (dB TYP @100Ω±15Ω)			
			L/R	1- 100 MHz	1- 10 MHz	30 MHz	60 80 MHz	80 – 100 MHz
ARJ11F-MASA-A-B-EM2	1CT:1CT	Yes	G/Y	-1	-20	-16	-12	-10
ARJ11F-MASB-A-B-EM2	1CT:1CT	Yes	G/Y	-1	-20	-16	-12	-10
ARJ11F-MBSC-L2	1CT:1	Yes	NONE	-1	-20	-16	-12	-10
ARJ11F-MASD-AB-A-FM2	1CT:1CT	Yes	G Y/G	-1	-20	-16	-12	-10
ARJ11F-MASE-A-A-EL2	1CT:1	Yes	G/G	-1	-20	-16	-12	-10
ARJ11F-MASF-AB-A-FL2	1CT:1	Yes	G Y/G	-1	-20	-16	-12	-10

Part Number	Crosstalk (dB TYP)			Common Mode Rejection (dB TYP)		Hipot (Vrms)
	1 - 10 MHz	32 - 65 MHz	65 - 100 MHz	1 - 125 MHz	125 -500 MHz	@60Hz
ARJ11F-MASA-A-B-EM2	-40	-35	-30	-30	-20	1500
ARJ11F-MASB-A-B-EM2	-40	-35	-30	-30	-20	1500
ARJ11F-MBSC-L2	-40	-35	-30	-30	-20	1500
ARJ11F-MASD-AB-A-FM2	-40	-35	-30	-30	-20	1500
ARJ11F-MASE-A-A-EL2	-40	-35	-30	-30	-20	1500
ARJ11F-MASF-AB-A-FL2	-40	-35	-30	-30	-20	1500

Contact Abracon for more custom configurations. See options to build a custom configuration.

## OPTIONS AND PART IDENTIFICATION

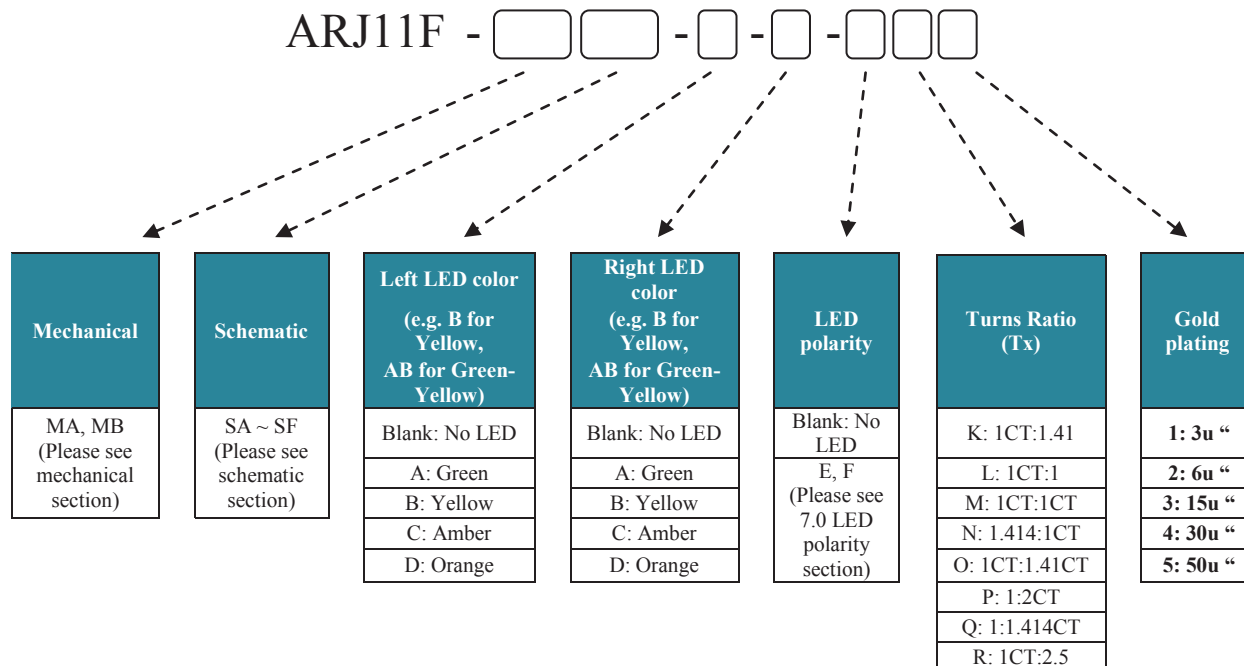

# RJ45 10/100/1000 Base-T Jack with Magnetic Module

ARJ11F

**RoHS**  
Compliant



16.26 x 13.84 x 21.59mm

## MECHANICAL DIMENSIONS

MA

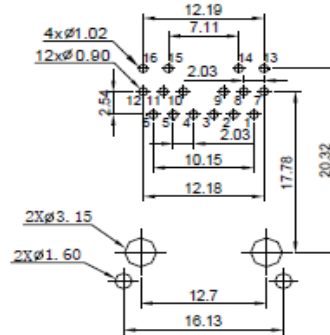
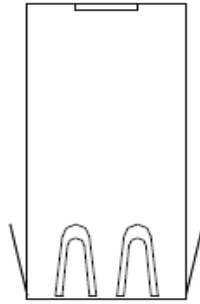

PC Board Layout  
Component Side Shown

LED

LED

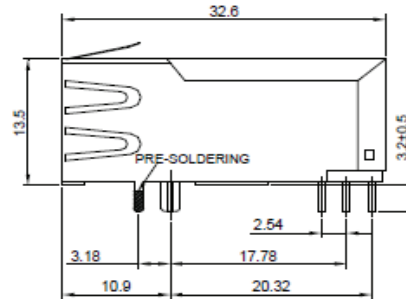
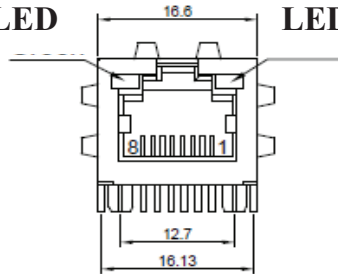

MB

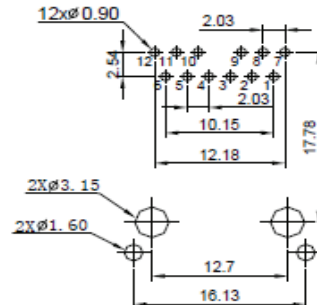
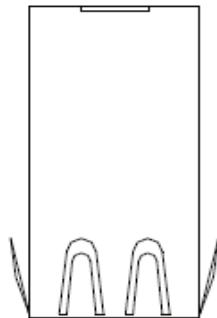

PC Board Layout  
Component Side Shown

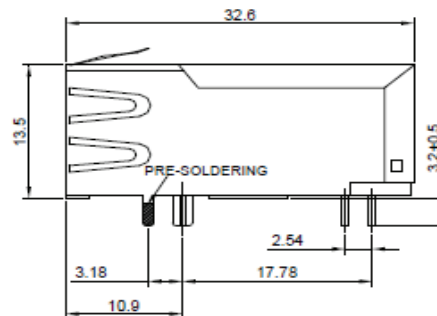
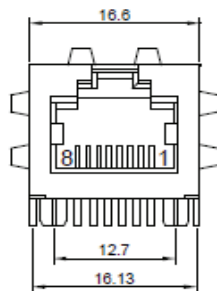

# RJ45 10/100/1000 Base-T Jack with Magnetic Module



16.26 x 13.84 x 21.59mm

**RoHS**  
Compliant

ARJ11F

## SCHEMATICS

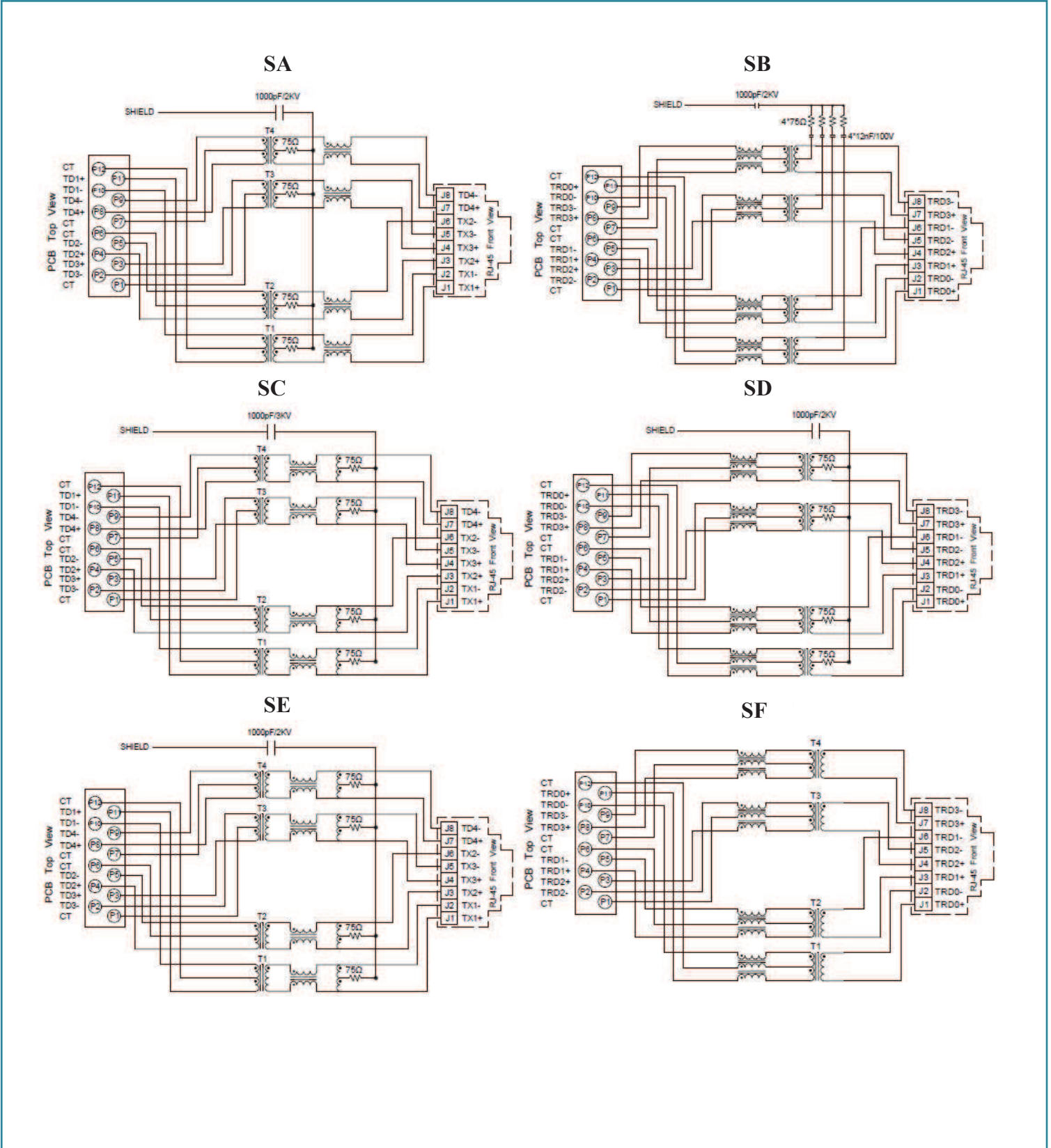

ABRACON IS  
ISO 9001:2008  
CERTIFIED

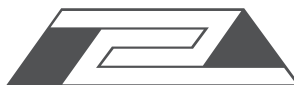

**ABRACON**  
CORPORATION

Visit [www.abracon.com](http://www.abracon.com) for Terms & Conditions of Sale  
30332 Esperanza, Rancho Santa Margarita, California 92688  
tel 949-546-8000 | fax 949-546-8001 | [www.abracon.com](http://www.abracon.com)

Revised: 05.09.11

# RJ45 10/100/1000 Base-T Jack with Magnetic Module

ARJ11F

RoHS  
Compliant



16.26 x 13.84 x 21.59mm

## LED POLARITY

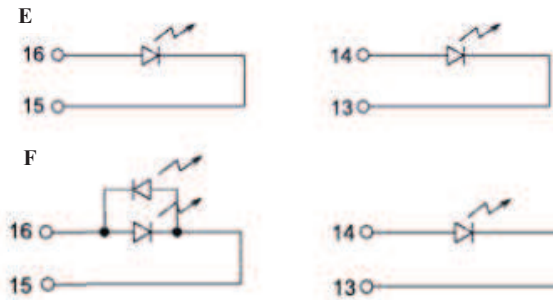

## PACKING: 60pcs/tray

Packaging material: PET

Outer carton unit 1320 pcs/ 22 Trays/box

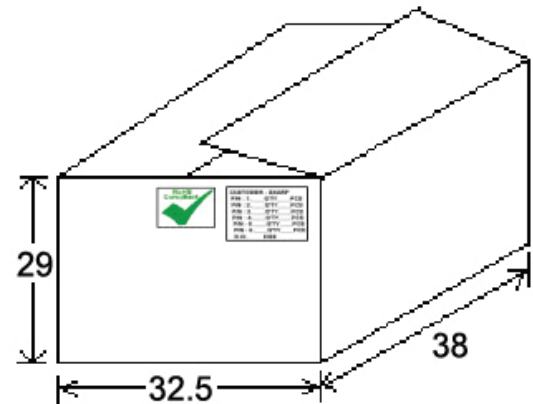
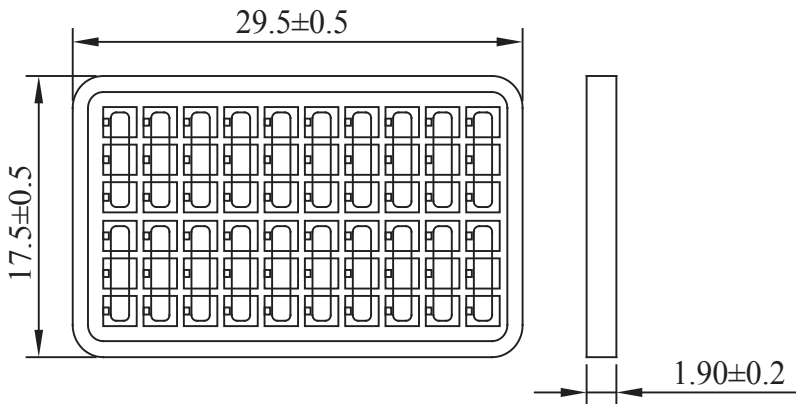

## REFLOW PROFILE:

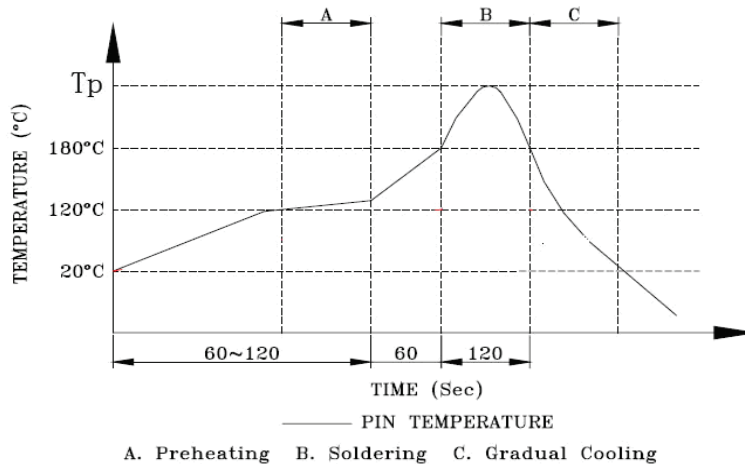

**ATTENTION:** Abracon Corporation's products are COTS – Commercial-Off-The-Shelf products; suitable for Commercial, Industrial and, where designated, Automotive Applications. Abracon's products are not specifically designed for Military, Aviation, Aerospace, Life-dependant Medical applications or any application requiring high reliability where component failure could result in loss of life and/or property. For applications requiring high reliability and/or presenting an extreme operating environment, written consent and authorization from Abracon Corporation is required. Please contact Abracon Corporation for more information.

ABRACON IS  
ISO 9001:2008  
CERTIFIED



**ABRACON**  
CORPORATION

Visit [www.abracon.com](http://www.abracon.com) for Terms & Conditions of Sale  
30332 Esperanza, Rancho Santa Margarita, California 92688  
tel 949-546-8000 | fax 949-546-8001 | [www.abracon.com](http://www.abracon.com)

Revised: 05.09.11