



Chipsmall Limited consists of a professional team with an average of over 10 year of expertise in the distribution of electronic components. Based in Hongkong, we have already established firm and mutual-benefit business relationships with customers from,Europe,America and south Asia,supplying obsolete and hard-to-find components to meet their specific needs.

With the principle of “Quality Parts,Customers Priority,Honest Operation,and Considerate Service”,our business mainly focus on the distribution of electronic components. Line cards we deal with include Microchip,ALPS,ROHM,Xilinx,Pulse,ON,Everlight and Freescale. Main products comprise IC,Modules,Potentiometer,IC Socket,Relay,Connector.Our parts cover such applications as commercial,industrial, and automotives areas.

We are looking forward to setting up business relationship with you and hope to provide you with the best service and solution. Let us make a better world for our industry!



## Contact us

Tel: +86-755-8981 8866 Fax: +86-755-8427 6832

Email & Skype: info@chipsmall.com Web: www.chipsmall.com

Address: A1208, Overseas Decoration Building, #122 Zhenhua RD., Futian, Shenzhen, China



# RJ45 PoE 10/100 Base-TX Jack with Magnetic Module

ARJP11B

**RoHS**  
Compliant



16.26 x 13.84 x 21.59mm

## FEATURES:

- Available with or without LED
- Suitable CAT 5 & 6 cable and UTP
- Comply IEEE 802.3ab
- LAN Magnetic with RJ4
- Suitable for RoHS compliant reflow

## APPLICATIONS:

- 10/100 Base-TX
- NIC, LoM and PC

## STANDARD SPECIFICATIONS at 25°C

**Operating temperature range: 0°C to +70°C    Storage temperature range: -40°C to +85°C**

Part Number	Turns Ratio Pri: Sec ± 3%		EMI Fingers	LEDs L/R	Insertion Loss (dB max) 0.3- 100 MHz	Return Loss (dB MIN @100Ω)			
	TX	RX				0.5- 30 MHz	40 MHz	50 MHz	60 – 80 MHz
ARJP11B-MASA-B-A-EMU2	1CT:1CT	1CT:1CT	Yes	Y/G	-1.1	-18	-15.5	-13.6	-12
ARJP11B-MBSB-A-B-EMU2	1CT:1CT	1CT:1CT	Yes	G/Y	-1.1	-18	-15.5	-13.6	-12

Part Number	Crosstalk (dB TYP) 0.3-100 MHz	Common Mode Rejection (dB TYP)			Hipot (Vrms min)
		0.3-30 MHz	30-60 MHz	60-100 MHz	
ARJP11B-MASA-B-A-EMU2	-38	-50	-40	-30	1500
ARJP11B-MBSB-A-B-EMU2	-38	-50	-40	-30	1500

Contact Abracon for more custom configurations. See options to build a custom configuration.

## OPTIONS AND PART IDENTIFICATION

ARJP11B - [ ] [ ] - [ ] - [ ] - [ ] [ ] [ ] [ ]

Mechanical	Schematic	Left LED color (e.g. B for Yellow, AB for Green- Yellow)	Right LED color (e.g. B for Yellow, AB for Green- Yellow)	LED polarity	Turns Ratio (Tx)	Turns Ratio (Rx)	Gold plating
MA, MB (Please see mechanical section)	SA, SB (Please see schematic section)	Blank: No LED A: Green B: Yellow C: Amber D: Orange	Blank: No LED A: Green B: Yellow C: Amber D: Orange	Blank: No LED E (Please see 7.0 LED polarity section)	K: 1CT:1.41 L: 1CT:1 M: 1CT:1CT N: 1.414:1CT O: 1CT:1.41CT P: 1:2CT Q: 1:1.414CT R: 1CT:2.5	S: 1CT:1.41 T: 1CT:1 U: 1CT:1CT V: 1.414:1CT W:1CT:1.41CT X: 1:2CT Y: 1:1.414CT Z: 1CT:2.5	1: 3u “ 2: 6u “ 3: 15u “ 4: 30u “ 5: 50u “



# RJ45 PoE 10/100 Base-TX Jack with Magnetic Module

ARJP11B

RoHS  
Compliant



16.26 x 13.84 x 21.59mm

## MECHANICAL DIMENSIONS

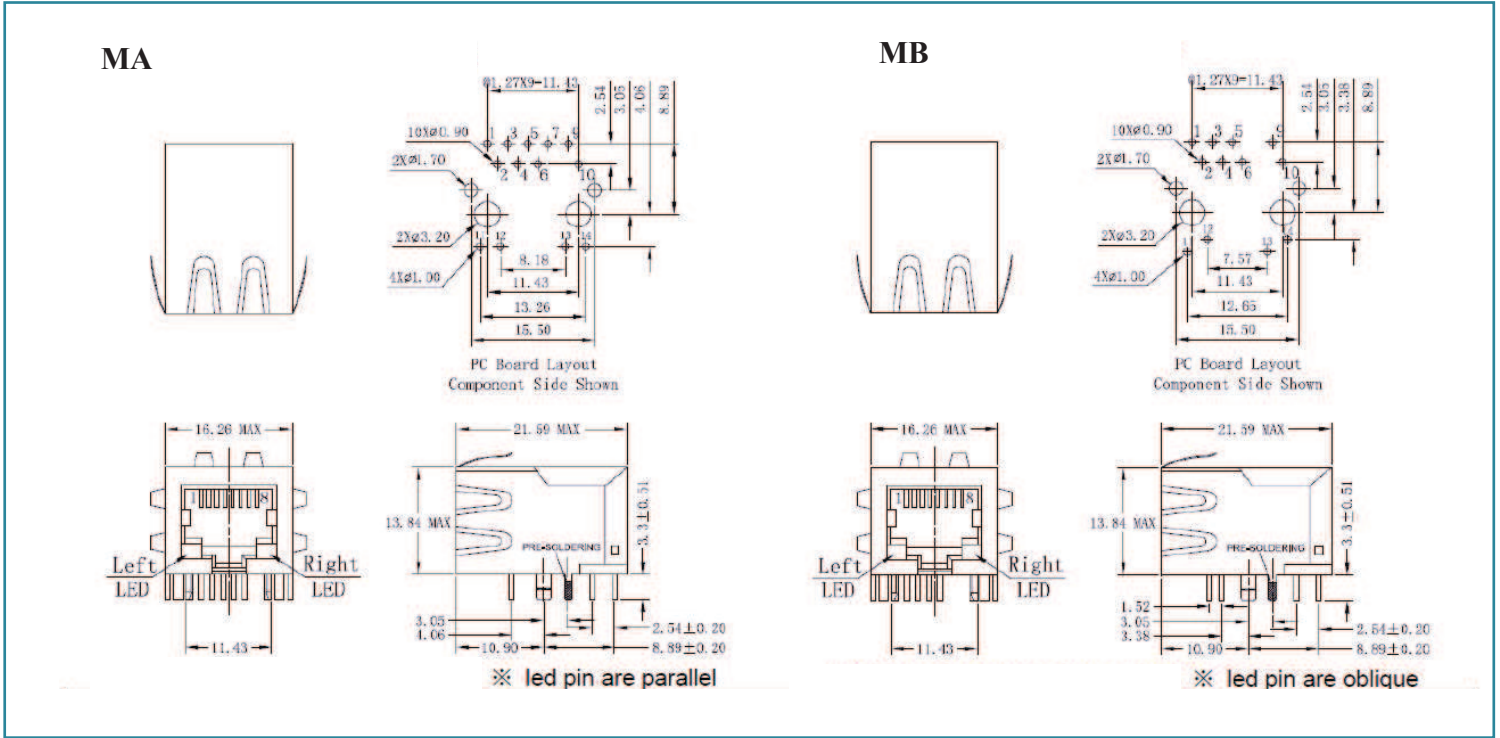

## SCHEMATICS

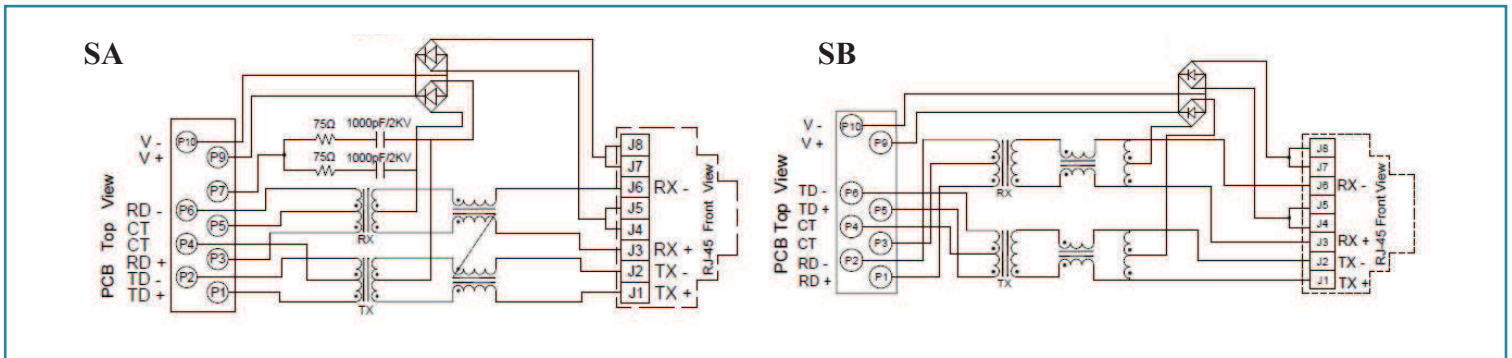

## LED POLARITY

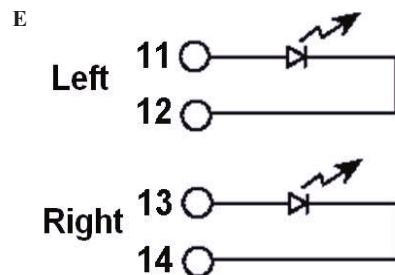

# RJ45 PoE 10/100 Base-TX Jack with Magnetic Module

ARJP11B

RoHS  
Compliant



16.26 x 13.84 x 21.59mm

PACKING: 60pcs/tray

Packaging material: PET

Outer carton unit 1320 pcs/ 22 Trays/box

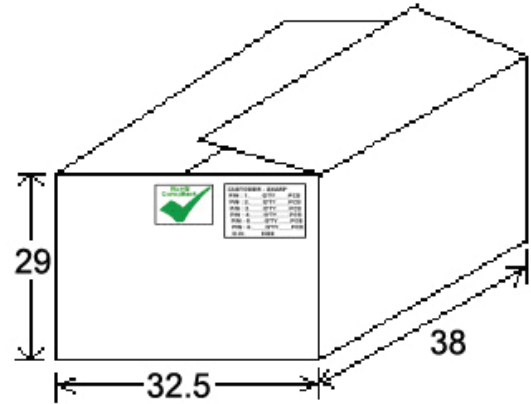
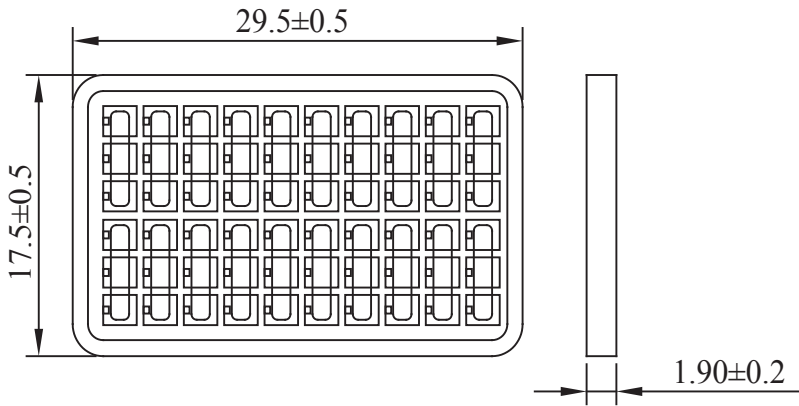

REFLOW PROFILE:

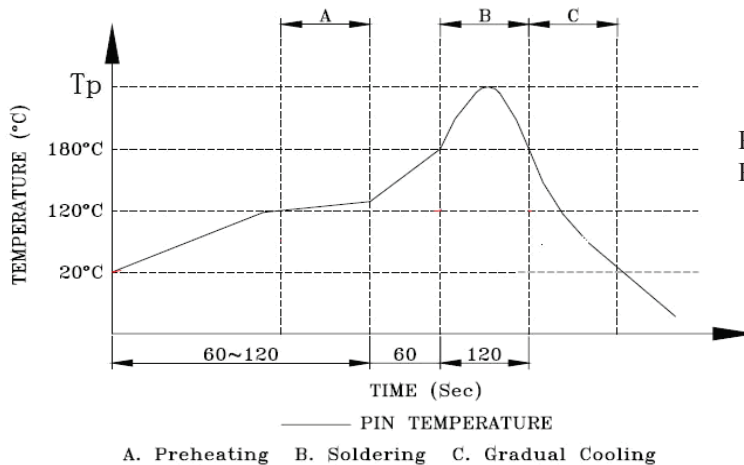

**ATTENTION:** Abracon Corporation's products are COTS – Commercial-Off-The-Shelf products; suitable for Commercial, Industrial and, where designated, Automotive Applications. Abracon's products are not specifically designed for Military, Aviation, Aerospace, Life-dependant Medical applications or any application requiring high reliability where component failure could result in loss of life and/or property. For applications requiring high reliability and/or presenting an extreme operating environment, written consent and authorization from Abracon Corporation is required. Please contact Abracon Corporation for more information.

ABRACON IS  
ISO 9001:2008  
CERTIFIED

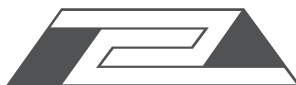

**ABRACON**  
CORPORATION

Visit [www.abracon.com](http://www.abracon.com) for Terms & Conditions of Sale  
30332 Esperanza, Rancho Santa Margarita, California 92688  
tel 949-546-8000 | fax 949-546-8001 | [www.abracon.com](http://www.abracon.com)

Revised: 05.13.16