



Chipsmall Limited consists of a professional team with an average of over 10 year of expertise in the distribution of electronic components. Based in Hongkong, we have already established firm and mutual-benefit business relationships with customers from,Europe,America and south Asia,supplying obsolete and hard-to-find components to meet their specific needs.

With the principle of “Quality Parts,Customers Priority,Honest Operation,and Considerate Service”,our business mainly focus on the distribution of electronic components. Line cards we deal with include Microchip,ALPS,ROHM,Xilinx,Pulse,ON,Everlight and Freescale. Main products comprise IC,Modules,Potentiometer,IC Socket,Relay,Connector.Our parts cover such applications as commercial,industrial, and automotives areas.

We are looking forward to setting up business relationship with you and hope to provide you with the best service and solution. Let us make a better world for our industry!



## Contact us

Tel: +86-755-8981 8866 Fax: +86-755-8427 6832

Email & Skype: info@chipsmall.com Web: www.chipsmall.com

Address: A1208, Overseas Decoration Building, #122 Zhenhua RD., Futian, Shenzhen, China





**austriamicrosystems AG**

**is now**

**ams AG**

The technical content of this austriamicrosystems datasheet is still valid.

**Contact information:**

**Headquarters:**

ams AG  
Tobelbaderstrasse 30  
8141 Unterpremstaetten, Austria  
Tel: +43 (0) 3136 500 0  
e-Mail: [ams\\_sales@ams.com](mailto:ams_sales@ams.com)

Please visit our website at [www.ams.com](http://www.ams.com)

# AS1106, AS1107

## 8-Digit LED Display Drivers

### 1 General Description

The AS1106 and the AS1107 are compact display drivers for 7-segment numeric displays of up to 8 digits. The devices can be programmed via SPI, QSPI, and Microwire as well as a conventional 4-wire serial interface.

The devices include an integrated BCD code-B/HEX decoder, multiplex scan circuitry, segment and display drivers, and a 64-bit memory. Internal memory stores the LED settings, eliminating the need for continuous device reprogramming.

Every segment can be individually addressed and updated separately. Only one external resistor (RSET) is required to set the current through the LED display. LED brightness can be controlled by analog or digital means. The devices can be programmed to use the internal code-B/HEX decoder to display numeric digits or to directly address each segment.

The AS1106 and the AS1107 feature an extremely low shutdown current of typically 3µA, and an operational current of less than 500µA. The number of digits can be programmed, the devices can be reset by software, and an external clock is also supported. Additionally, segment blinking can be synchronized across multiple drivers.

Several test modes are available for easy application debugging.

The devices are available in a SOIC 24-pin package.

### 2 Key Features

- 10MHz SPI-, QSPI-, Microwire-Compatible Serial I/O
- Individual LED Segment Control
- Segment Blinking Control (can be synchronized across multiple drivers)
- Hexadecimal- or BCD-Code/No-Decode Digit Selection
- 3µA Low-Power Shutdown Current (typ; data retained)
- Extremely Low Operating Current 0.5mA in Open-Loop
- Digital and Analog Brightness Control
- Display Blanked on Power-Up
- Drive Common-Cathode LED Displays
- Low-EMI Low Slew-Rate Limited Segment Drivers (AS1107)
- Supply Voltage Range: 2.7 to 5.5V
- Software Reset
- Optional External Clock
- SOIC 24-pin Package

### 3 Applications

The AS1106 and AS1107 are ideal for bar-graph displays, instrument-panel meters, LED matrix displays, dot matrix displays, set-top boxes, white goods, professional audio equipment, medical equipment, industrial controllers and panel meters.

Figure 1. AS1106, AS1107 - Typical Application Diagram

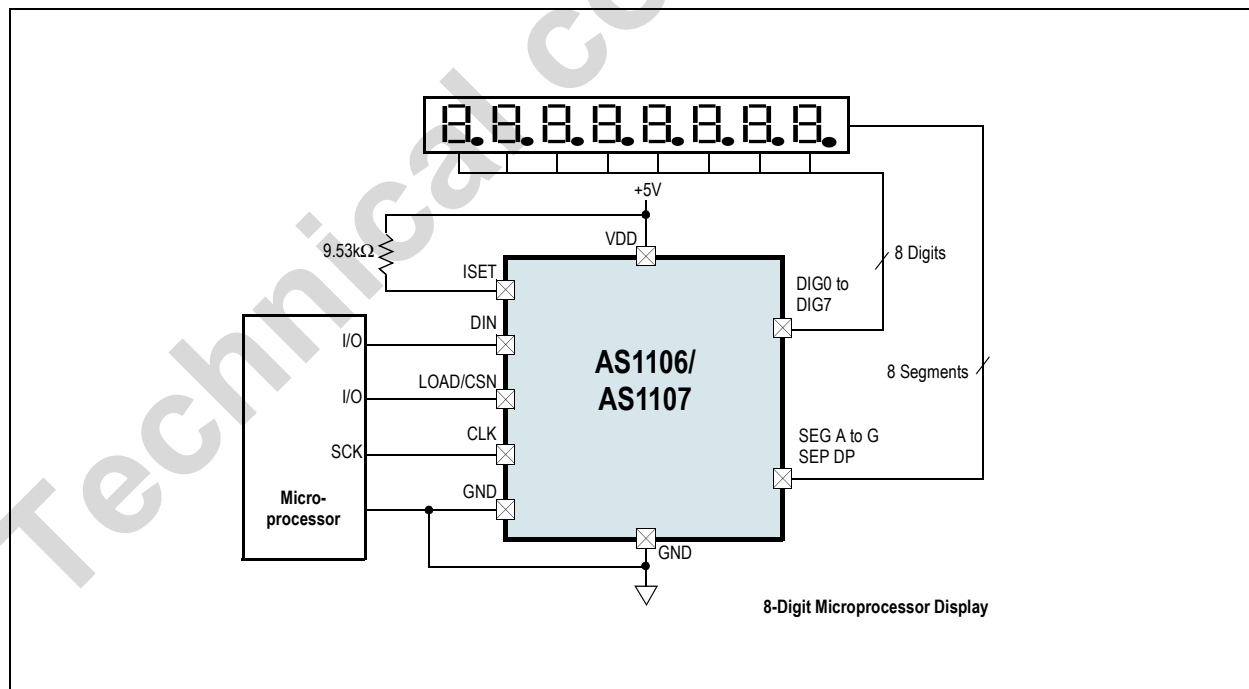

## 4 Pin Assignments

Figure 2. Pin Assignments (Top View)

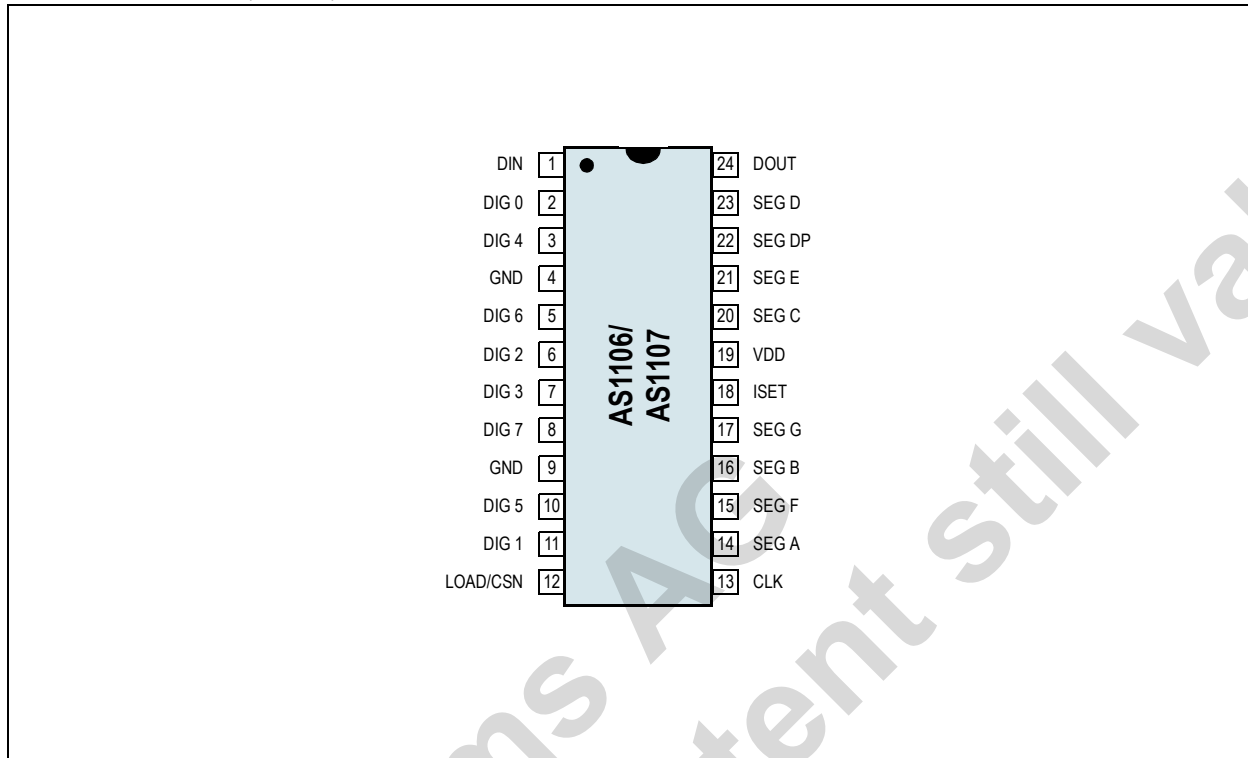

### 4.1 Pin Descriptions

Table 1. Pin Descriptions

Pin Number	Pin Name	Description
1	DIN	<b>Serial-Data Input.</b> Data is loaded into the internal 16-bit shift register on the rising edge of pin CLK.
2, 3, 5, 6, 7, 8, 10, 11	DIG 0: DIG 7	<b>Digit Drive Lines.</b> 8 Eight-digit drive lines that sink current from the display common cathode. The AS1106 pulls the digit outputs to VDD when turned off. The AS1107 digit drivers are high-impedance when turned off.
4, 9	GND	<b>Ground.</b> Both GND pins must be connected.
12	LOAD/CSN	<b>Load-Data Input (AS1106 only).</b> The last 16 bits of serial data are latched on the rising edge of this pin. <b>Chip-Select Input (AS1107 or AS1106 SPI-enabled only).</b> Serial data is loaded into the shift register while this pin is low. The last 16 bits of serial data are latched on the rising edge of this pin.
13	CLK	<b>Serial-Clock Input.</b> 10MHz maximum rate. Data is shifted into the internal shift register on the rising edge of this pin. Data is clocked out of pin DOUT on the falling edge of this pin. On the AS1107 or AS1106 SPI-enabled, the CLK input is active only while LOAD/CSN is low.
14, 15, 16, 17, 20, 21, 22, 23	SEG A: SEG G, SEG DP	<b>Seven Segment and Decimal Point Drive Lines.</b> 8 seven-segment drives and decimal point drive that source current to the display. On the AS1106, when a segment driver is turned off it is pulled to GND. The AS1107 segment drivers are high-impedance when turned off.
18	ISET	<b>Set Segment Current.</b> Connect to VDD through RSET to set the peak segment current (see <a href="#">Selecting RSET Resistor Value and Using External Drivers on page 14</a> ).
19	VDD	<b>Positive Supply Voltage.</b> Connect to +2.7 to +5.5V supply.
24	DOUT	<b>Serial-Data Output.</b> The data into pin DIN is valid at pin DOUT 16.5 clock cycles later. This pin is used to daisy-chain several AS1106/AS1107 devices and is never high-impedance.

## 5 Absolute Maximum Ratings

Stresses beyond those listed in [Table 2](#) may cause permanent damage to the device. These are stress ratings only, and functional operation of the device at these or any other conditions beyond those indicated in [Electrical Characteristics on page 4](#) is not implied. Exposure to absolute maximum rating conditions for extended periods may affect device reliability.

Table 2. Absolute Maximum Ratings

Parameter	Min	Max	Units	Notes
<b>Electrical Parameters</b>				
VDD to GND	-0.3	7	V	
All other pins to GND	-0.3	VDD + 0.3 (max 7V)	V	
<b>Current</b>				
DIG 0: DIG 7 Sink Current		500	mA	
SEG A: SEG G, SEG DP		100	mA	
Latch-Up Immunity		±200	mA	All pins except AS1106 pin 14: ±180 mA Norm: JEDEC 78
<b>Electrostatic Discharge</b>				
Digital outputs		1000	V	Norm: MIL 883 E method 3015
All other pins		1000	V	
<b>Continuous Power Dissipation (TA = +85°C)</b>				
Wide SOIC		941	mW	Derate 11.8mW/°C above +70°C
<b>Temperature Ranges and Storage Conditions</b>				
Storage Temperature Range	-55	+150	°C	
Package Body Temperature (Wide SOIC)		+260	°C	The reflow peak soldering temperature (body temperature) specified is in accordance with <i>IPC/JEDEC J-STD-020 "Moisture/Reflow Sensitivity Classification for Non-Hermetic Solid State Surface Mount Devices"</i> . The lead finish for Pb-free leaded packages is matte tin (100% Sn).
Humidity	5	85	%	Non-condensing
Moisture Sensitive Level		3		Represents a max. floor life time of 168h

## 6 Electrical Characteristics

$V_{DD} = 2.7V$  to  $5.5V$ ,  $R_{SET} = 9.53k\Omega \pm 1\%$ ,  $T_{AMB} = T_{MIN}$  to  $T_{MAX}$  (unless otherwise specified). All limits are guaranteed. The parameters with min and max values are guaranteed with production tests or SQC (Statistical Qualification Control) methods.

Table 3. Electrical Characteristics

Symbol	Parameter	Conditions	Min	Typ	Max	Unit
$T_{AMB}$	Operating Temperature Range		-40		+85	°C
$V_{DD}$	Operating Supply Voltage		2.7	5.0	5.5	V
$I_{DDSD}$	Shutdown Supply Current	All digital inputs at $V_{DD}$ or GND, $T_{AMB} = +25^{\circ}C$			10	$\mu A$
$I_{DD}$	Operating Supply Current	$R_{SET} =$ open circuit.			1	mA
		All segments and decimal point on; $I_{SEG} = -40mA$ .		330		
$f_{OSC}$	Display Scan Rate	8 digits scanned	500	800	1300	Hz
$I_{DIGIT}$	Digit Drive Sink Current	$V_{OUT} = 0.65V$	320			mA
$I_{SEG}$	Segment Drive Source Current	$V_{DD} = 5.0V$ , $V_{OUT} = (V_{DD} - 1V)$	-30	-40	-45	mA
$\Delta I_{SEG}/\Delta t$	Segment Current Slew Rate (AS1107 only)	$T_{AMB} = +25^{\circ}C$ , $V_{DD} = 5.0V$ , $V_{OUT} = (V_{DD} - 1V)$	10	20	50	mA/ $\mu s$
$\Delta I_{SEG}$	Segment Drive Current Matching			3.0		%
$I_{DIGIT}$	Digit Drive Leakage (AS1107 only)	Digit off, $V_{DIGIT} = V_{DD}$			-10	$\mu A$
$I_{SEG}$	Segment Drive Leakage (AS1107 only)	Segment off, $V_{SEG} = 0V$			1	$\mu A$
$I_{DIGIT}$	Digit Drive Source Current (AS1106 only)	Digit off, $V_{DIGIT} = (V_{DD} - 0.3V)$	-2			mA
$I_{SEG}$	Segment Drive Sink Current (AS1106 only)	Segment off, $V_{SEG} = 0.3V$	5			mA
$t_{SLOWBLINK}$	Slow Segment Blink Period (ON phase, Internal Oscillator)		0.64	1	1.65	s
$t_{FASTBLINK}$	Fast Segment Blink Period (ON phase, Internal Oscillator)		0.32	0.5	0.83	s
	Fast or Slow Segment Blink Duty Cycle (Guaranteed by design)		49.9	50	50.1	%

Table 4. Logic Inputs/Outputs Characteristics

Symbol	Parameter	Conditions	Min	Typ	Max	Unit
$I_{IH}$ , $I_{IL}$	Input Current DIN, CLK, LOAD/CSN	$V_{IN} = 0V$ or $V_{DD}$	-1		1	$\mu A$
$V_{IH}$	Logic High Input Voltage		$0.7 \times V_{DD}$			V
$V_{IL}$	Logic Low Input Voltage	$V_{DD} = 5.0V \pm 10\%$			0.8	V
		$V_{DD} = 3.0V \pm 10\%$			0.6	
$V_{OH}$	Output High Voltage	$D_{OUT}$ , $I_{SOURCE} = -1mA$ , $V_{DD} = 5.0V \pm 10\%$	$V_{DD} - 1$			V
		$D_{OUT}$ , $I_{SOURCE} = -1mA$ , $V_{DD} = 3.0V \pm 10\%$	$V_{DD} - 0.5$			
$V_{OL}$	Output Low Voltage	$D_{OUT}$ , $I_{SINK} = 1.6mA$			0.4	V
$\Delta V_I$	Hysteresis Voltage	DIN, CLK, LOAD/CSN		1		V

Table 5. Timing Characteristics (see Figure 12 on page 8)

Symbol	Parameter	Conditions	Min	Typ	Max	Unit
tCP	CLK Clock Period		100			ns
tCH	CLK Pulse Width High		50			ns
tCL	CLK Pulse Width Low		50			ns
tCSS	CSM Fall to CLK Rise Setup Time (AS1107 or AS1106 SPI-programmed)		25			ns
tCSH	CLK Rise to LOAD/CSN Rise Hold Time		0			ns
tDS	DIN Setup Time		25			ns
tDH	DIN Hold Time		0			ns
tDO	Output Data Propagation Delay	CLOAD = 50pF			25	ns
tLDCK	LOAD Rising Edge to Next Clock Rising Edge (AS1106 only)		50			ns
tCSW	Minimum LOAD/CSN Pulse High		50			ns
tDSPD	Data-to-Segment Delay				2.25	ms

## 7 Typical Operating Characteristics

$V_{DD} = 5V$ ,  $R_{SET} = 9.53k\Omega$ ,  $T_{AMB} = 25^{\circ}C$  (unless otherwise specified).

Figure 3. Scan Frequency vs. Temperature

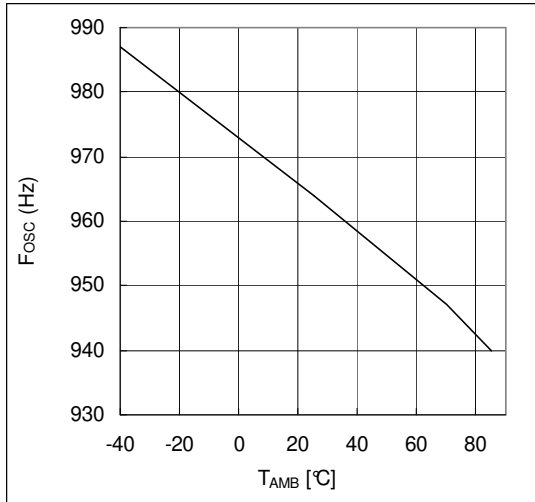

Figure 4. Scan Frequency vs.  $V_{DD}$

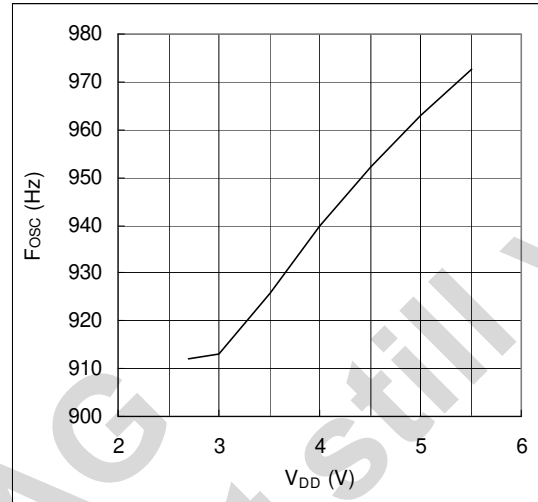

Figure 5.  $I_{SEG}$  vs. Temperature

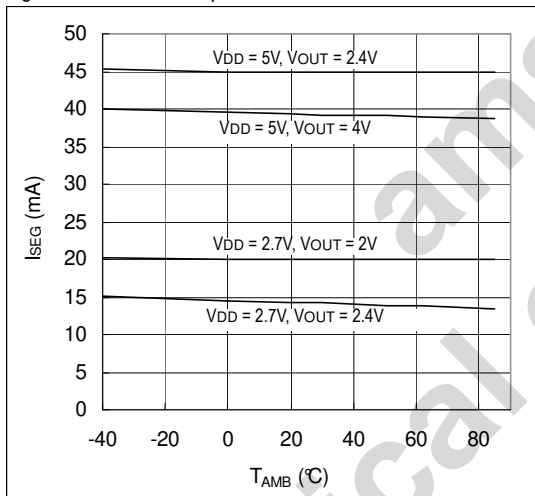

Figure 6.  $I_{SEG}$  vs.  $V_{DD}$

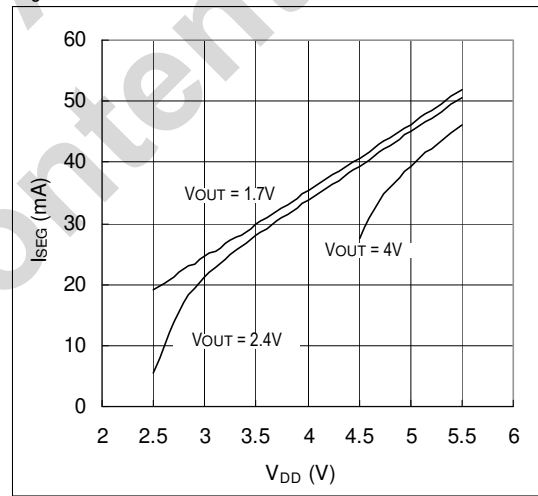



Figure 7. AS1106 Segment Output Current

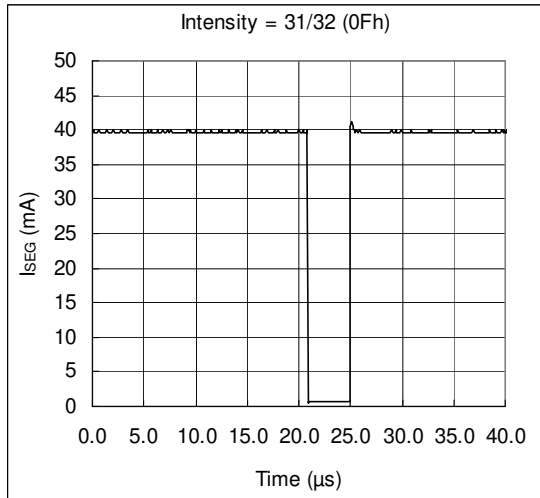

Figure 8. AS1107 Segment Output Current

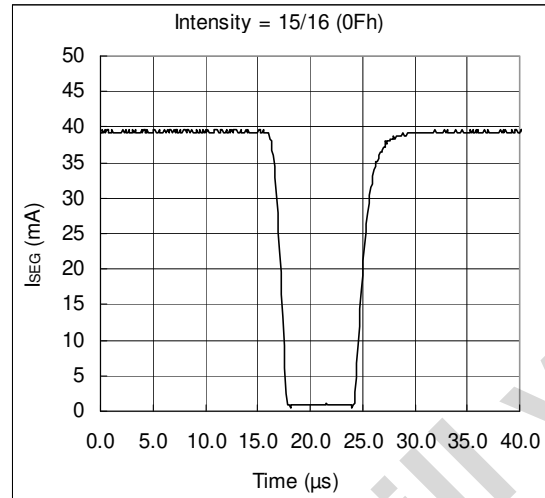

Figure 9. ISEG vs. VOUT

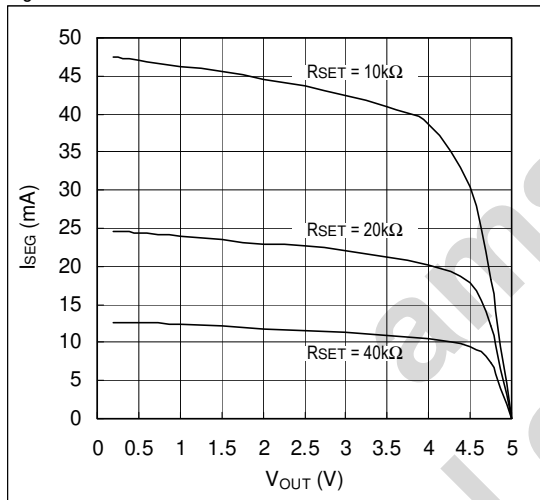

Figure 10. ISEG vs. VOUT

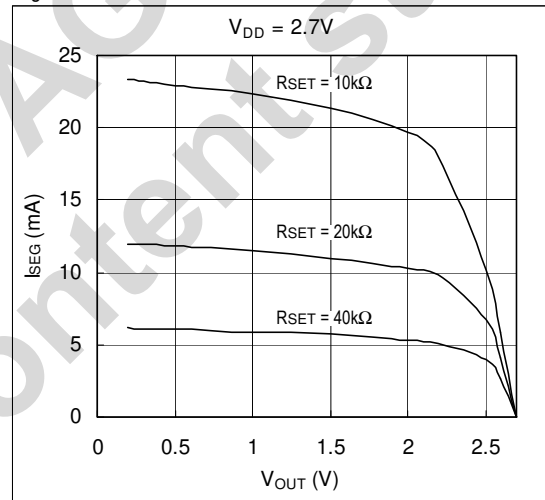
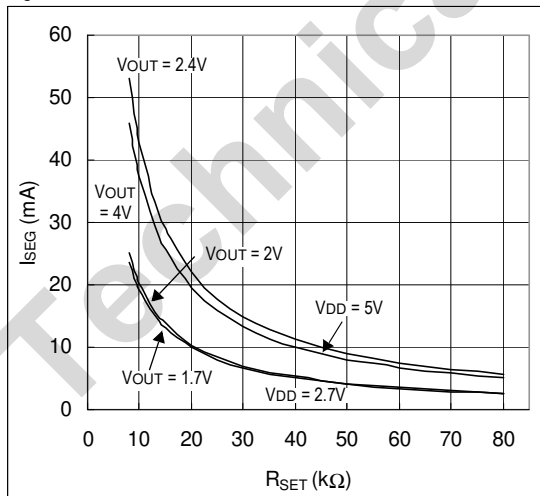

Figure 11. ISEG vs. RSET



## 8 Detailed Description

### 8.1 AS1106 vs. AS1107

The AS1106 and AS1107 are identical except for two features:

- The AS1107 segment drivers are slew-rate limited to reduce electromagnetic interference (EMI).
- The AS1107 serial interface is fully SPI compatible (programmable for AS1106).

### 8.2 Serial-Addressing Format

Programming the AS1106/AS1107 is done by writing to the device's internal registers (see Digit- and Control-Registers on page 9) via the 4-wire serial interface. A programming sequence consists of 16-bit packages as listed in [Table 6](#).

The data is shifted into the internal 16-bit register with the rising edge of the CLK signal. With the rising edge of the LOAD/CSN signal the data is latched into a digit- or control-register. The LOAD/CSN signal must go high after the 16th rising clock edge.

The LOAD/CSN signal can also come later but this must happen just before the next rising edge of CLK, otherwise the data will be lost. The contents of the internal shift register are applied 16.5 clock cycles later to pin DOUT. The data is clocked out at the falling edge of CLK.

The first 4 bits (D15:D12) are "don't care", bits D11:D8 contain the register address, and bits D7:D0 contain the data. The first bit is D15, the most significant bit (MSB). The exact timing is shown in [Figure 12](#).

Table 6. 16-Bit Serial Data Format

D15	D14	D13	D12	D11	D10	D9	D8	D7	D6	D5	D4	D3	D2	D1	D0
X	X	X	X	Register Address (see <a href="#">Table 7</a> )				MSB			Data			LSB	

### 8.3 Initial Power-Up

On initial power-up, the AS1106/AS1107 registers are reset to their default values, the display is blanked, and the device goes into shutdown mode. At this time, all registers should be programmed for normal operation.

**Note:** The default settings enable only scanning of one digit; the internal decoder is disabled and the Intensity Control Register (see page 12) is set to the minimum values.

Figure 12. Interface Timing

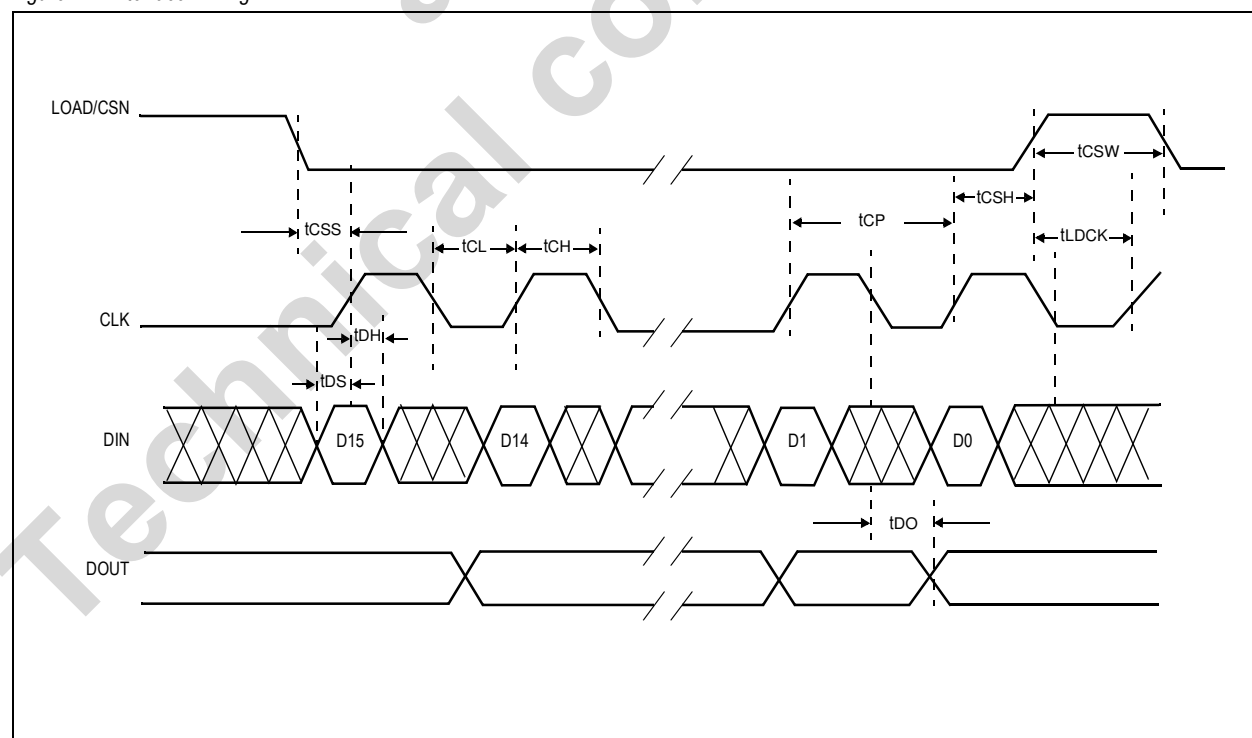

## 8.4 Shutdown Mode

The AS1106/AS1107 devices feature a shutdown mode, where they consume only 10µA (max) current. Shutdown mode is entered via a write to the Shutdown Register (see Table 8). For the AS1106, at that point, all segment current sources are pulled to ground and all digit drivers are connected to VDD, so that all segments are blanked. The AS1107 behavior is identical except the drivers are high impedance.

**Note:** During shutdown mode the Digit-Registers maintain their data.

Shutdown mode can either be used as a means to reduce power consumption or for generating a flashing display (repeatedly entering and leaving shutdown mode). For minimum supply current in shutdown mode, logic input should be at GND or VDD (CMOS logic level).

The devices need typically 250µs to exit shutdown mode, and during shutdown mode the AS1106/AS1107 is fully programmable. Only the display test mode (see page 11) overrides shutdown mode.

When entering or leaving shutdown mode, the Feature Register is reset to its default values (all 0s) when Shutdown Register bit D7 (page 10) = 0.<sup>1</sup>

**Note:** If the AS1106/AS1107 is used with an external clock, Shutdown Register bit D7 should be set to 1 when writing to the Shutdown Register.

## 8.5 Digit- and Control-Registers

The AS1106/AS1107 devices contain 8 Digit-Registers and 6 control-registers, which are listed in Table 7. All registers are selected using a 4-bit address word, and communication is done via the serial interface.

- Digit Registers – These registers are realized with an on-chip 64-bit memory. Each digit can be controlled directly without rewriting the whole register contents.
- Control Registers – These registers consist of decode mode, display intensity, number of scanned digits, shutdown, display test and features selection registers.

Table 7. Register Address Map

Register	HEX Code	Address					Page
		D15:D12	D11	D10	D9	D8	
No-Op	0xX0	X	0	0	0	0	13
Digit 0	0xX1	X	0	0	0	1	N/A
Digit 1	0xX2	X	0	0	1	0	N/A
Digit 2	0xX3	X	0	0	1	1	N/A
Digit 3	0xX4	X	0	1	0	0	N/A
Digit 4	0xX5	X	0	1	0	1	N/A
Digit 5	0xX6	X	0	1	1	0	N/A
Digit 6	0xX7	X	0	1	1	1	N/A
Digit 7	0xX8	X	1	0	0	0	N/A
Decode-Mode	0xX9	X	1	0	0	1	10
Intensity Control	0xXA	X	1	0	1	0	12
Scan Limit	0xXB	X	1	0	1	1	12
Shutdown	0xXC	X	1	1	0	0	10
N/A	0xD	X	1	1	0	1	N/A
Feature	0xE	X	1	1	1	0	13
Display Test	0xF	X	1	1	1	1	11

1. When Shutdown Register bit D7 = 1, the Feature Register is left unchanged when entering or leaving shutdown mode.

### 8.5.1 Shutdown Register (0xXC)

The Shutdown Register controls AS1106/AS1107 shutdown mode (see Shutdown Mode on page 9).

Table 8. Shutdown Register Format (Address (HEX) = 0xXC)

Mode	HEX Code	Register Data							
		D7	D6	D5	D4	D3	D2	D1	D0
Shutdown Mode, Reset Feature Register to Default Settings	0x00	0	X	X	X	X	X	X	0
Shutdown Mode, Feature Register Unchanged	0x80	1	X	X	X	X	X	X	0
Normal Operation, Reset Feature Register to Default Settings	0x01	0	X	X	X	X	X	X	1
Normal Operation, Feature Register Unchanged	0x81	1	X	X	X	X	X	X	1

### 8.5.2 Decode Enable Register (0xX9)

The Decode Enable Register sets the decode mode. BCD/HEX decoding (either BCD code – characters 0:9, E, H, L, P, and -, or HEX code – characters 0:9 and A:F) is selected by bit D2 (page 13) of the Feature Register. The Decode Enable Register is used to select the decode mode or no-decode for each digit. Each bit in the Decode Enable Register corresponds to its respective display digit (i.e., bit D0 corresponds to digit 0, bit D1 corresponds to digit 1 and so on). Table 10 lists some examples of the possible settings for the Decode Enable Register bits.

**Note:** A logic high enables decoding and a logic low bypasses the decoder altogether.

When decode mode is used, the decoder looks only at the lower-nibble (bits D3:D0) of the data in the Digit-Registers, disregarding bits D6:D4. Bit D7 sets the decimal point (SEG DP) independent of the decoder and is positive logic (bit D7 = 1 turns the decimal point on). Table 10 lists the code-B font; Table 11 lists the HEX font.

When no-decode mode is selected, data bits D7:D0 of the Digit-Registers correspond to the segment lines of the AS1106/AS1107. Table 12 shows the 1:1 pairing of each data bit to the appropriate segment line.

Table 9. Decode Enable Register Format (Address (HEX) = 0xX9)

Decode Mode	HEX Code	Register Data							
		D7	D6	D5	D4	D3	D2	D1	D0
No decode for digits 7:0	0x00	0	0	0	0	0	0	0	0
Code-B/HEX decode for digit 0. No decode for digits 7:1	0x01	0	0	0	0	0	0	0	1
Code-B/HEX decode for digits 3:0. No decode for digits 7:4	0x0F	0	0	0	0	1	1	1	1
Code-B/HEX decode for digits 7:0	0xFF	1	1	1	1	1	1	1	1

Figure 13. Standard 7-Segment LED Intensity Control and Inter-Digit Blanking

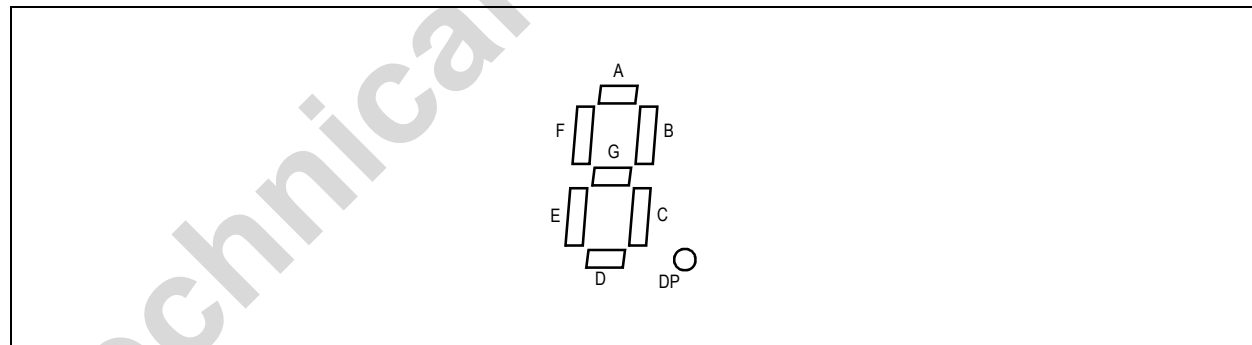

Table 10. Code-B Font

7-Segment Character	Register Data							On Segments = 1						
	D7 <sup>†</sup>	D6:D4	D3	D2	D1	D0	DP <sup>†</sup>	A	B	C	D	E	F	G
0		X	0	0	0	0		1	1	1	1	1	1	0
1		X	0	0	0	1		0	1	1	0	0	0	0
2		X	0	0	1	0		1	1	0	1	1	0	1
3		X	0	0	1	1		1	1	1	1	0	0	1
4		X	0	1	0	0		0	1	1	0	0	1	1

Table 10. Code-B Font (Continued)

7-Segment Character	Register Data							On Segments = 1						
	D7 <sup>†</sup>	D6:D4	D3	D2	D1	D0	DP <sup>†</sup>	A	B	C	D	E	F	G
5		X	0	1	0	1		1	0	1	1	0	1	1
6		X	0	1	1	0		1	0	1	1	1	1	1
7		X	0	1	1	1		1	1	1	0	0	0	0
8		X	1	0	0	0		1	1	1	1	1	1	1
9		X	1	0	0	1		1	1	1	1	0	1	1
-		X	1	0	1	0		0	0	0	0	0	0	1
E		X	1	0	1	1		1	0	0	1	1	1	1
H		X	1	1	0	0		0	1	1	0	1	1	1
L		X	1	1	0	1		0	0	0	1	1	1	0
P		X	1	1	1	0		1	1	0	0	1	1	1
Blank		X	1	1	1	1		0	0	0	0	0	0	0

<sup>†</sup> The decimal point is enabled by setting bit D7 = 1.

Table 11. HEX Font

7-Segment Character	Register Data							On Segments = 1						
	D7 <sup>†</sup>	D6:D4	D3	D2	D1	D0	DP <sup>†</sup>	A	B	C	D	E	F	G
0		X	0	0	0	0		1	1	1	1	1	1	0
1		X	0	0	0	1		0	1	1	0	0	0	0
2		X	0	0	1	0		1	1	0	1	1	0	1
3		X	0	0	1	1		1	1	1	1	0	0	1
4		X	0	1	0	0		0	1	1	0	0	1	1
5		X	0	1	0	1		1	0	1	1	0	1	1
6		X	0	1	1	0		1	0	1	1	1	1	1
7		X	0	1	1	1		1	1	1	0	0	0	0
8		X	1	0	0	0		1	1	1	1	1	1	1
9		X	1	0	0	1		1	1	1	1	0	1	1
A		X	1	0	1	0		1	1	1	0	1	1	1
b		X	1	0	1	1		0	0	1	1	1	1	1
C		X	1	1	0	0		1	0	0	1	1	1	0
d		X	1	1	0	1		0	1	1	1	1	0	1
E		X	1	1	1	0		1	0	0	1	1	1	1
F		X	1	1	1	1		1	0	0	0	1	1	1

<sup>†</sup> The decimal point is enabled by setting bit D7 = 1.

Table 12. No-Decode Mode Data Bits and Corresponding Segment Lines

	D7	D6	D5	D4	D3	D2	D1	D0
Corresponding Segment Line	DP	A	B	C	D	E	F	G

### 8.5.3 Display-Test Register (0xXF)

The AS1106/AS1107 devices can operate in two modes: normal mode and display test mode. In display test mode all LEDs are switched on at maximum brightness (duty cycle is 15/16 (AS1106) or 31/32 (AS1107)). The devices remain in display-test mode until the Display-Test Register is set for normal operation.

**Note:** All settings of the digit- and control-registers are maintained.

Table 13. Display-Test Register Format (Address (HEX) = 0xXF)

Mode	Register Data							
	D7	D6	D5	D4	D3	D2	D1	D0
Normal Operation	X	X	X	X	X	X	X	0
Display Test Mode	X	X	X	X	X	X	X	1

### 8.5.4 Intensity Control Register (0xA)

The brightness of the display can be controlled by digital means using the Intensity Control Register and by analog means using RSET (see [Selecting RSET Resistor Value and Using External Drivers on page 14](#)).

Display brightness is controlled by an integrated pulse-width modulator which is controlled by the lower-nibble of the Intensity Control Register. The modulator scales the average segment-current in 16 steps from a maximum of 31/32 down to 1/32 (15/16 to 1/16 for the AS1107) of the peak current set by RSET.

Table 14. Intensity Register Format (Address (HEX) = 0xA)

Duty Cycle		HEX Code	Register Data							
AS1106	AS1107		D7	D6	D5	D4	D3	D2	D1	D0
1/32 (min on)	1/16 (min on)	0xX0	X	X	X	X	0	0	0	0
3/32	2/16	0xX1	X	X	X	X	0	0	0	1
5/32	3/16	0xX2	X	X	X	X	0	0	1	0
7/32	4/16	0xX3	X	X	X	X	0	0	1	1
9/32	5/16	0xX4	X	X	X	X	0	1	0	0
11/32	6/16	0xX5	X	X	X	X	0	1	0	1
13/32	7/16	0xX6	X	X	X	X	0	1	1	0
15/32	8/16	0xX7	X	X	X	X	0	1	1	1
17/32	9/16	0xX8	X	X	X	X	1	0	0	0
19/32	10/16	0xX9	X	X	X	X	1	0	0	1
21/32	11/16	0xA	X	X	X	X	1	0	1	0
23/32	12/16	0xB	X	X	X	X	1	0	1	1
25/32	13/16	0xC	X	X	X	X	1	1	0	0
27/32	14/16	0xD	X	X	X	X	1	1	0	1
29/32	15/16	0xE	X	X	X	X	1	1	1	0
31/32 (max on)	15/16 (max on)	0xF	X	X	X	X	1	1	1	1

### 8.5.5 Scan-Limit Register (0xB)

The Scan-Limit Register controls which of the digits are to be displayed. When all 8 digits are to be displayed, the update frequency is typically 800Hz. If the number of digits displayed is reduced, the update frequency is increased. The frequency can be calculated using  $8f_{OSC}/N$ , where N is the number of digits. Since the number of displayed digits influences the brightness, RSET should be adjusted accordingly. [Table 16](#) lists the maximum allowed current when fewer than 4 digits are used.

**Note:** To avoid differences in brightness this register should not be used to blank parts of the display (leading zeros).

Table 15. Scan-Limit Register Format (Address (HEX) = 0xB)

Scan Limit	HEX Code	Register Data							
		D7	D6	D5	D4	D3	D2	D1	D0
Display digit 0 only (see <a href="#">Table 16</a> )	0xX0	X	X	X	X	X	0	0	0
Display digits 0:1 (see <a href="#">Table 16</a> )	0xX1	X	X	X	X	X	0	0	1
Display digits 0:2 (see <a href="#">Table 16</a> )	0xX2	X	X	X	X	X	0	1	0
Display digits 0:3	0xX3	X	X	X	X	X	0	1	1
Display digits 0:4	0xX4	X	X	X	X	X	1	0	0
Display digits 0:5	0xX5	X	X	X	X	X	1	0	1
Display digits 0:6	0xX6	X	X	X	X	X	1	1	0
Display digits 0:7	0xX7	X	X	X	X	X	1	1	1

Table 16. Maximum Segment Current for 1-, 2-, or 3-Digit Displays

Number of Digits Displayed	Maximum Segment Current (mA)
1	10
2	20
3	30

### 8.5.6 Feature Register (0xXE)

The Feature Register is used for enabling various features including switching the device into external clock mode, applying an external reset, selecting code-B or HEX decoding, enabling or disabling blinking, enabling or disabling the SPI-compatible interface (AS1106 only), setting the blinking rate, and resetting the blink timing.

**Note:** At power-up the Feature Register is initialized to 0.

Table 17. Feature Register Summary

D7	D6	D5	D4	D3	D2	D1	D0
blink_start	sync	blink_freq_sel	blink_en	spi_en	decode_sel	reg_res	clk_en

Table 18. Feature Register Bit Descriptions (Address (HEX) = 0xXE)

Addr: 0xXE		Feature Register		
Enables and disables various device features.				
Bit	Bit Name	Default	Access	Bit Description
D0	clk_en	0	R/W	External clock active. 0 = Internal oscillator is used for system clock. 1 = Pin CLK of the serial interface operates as system clock input.
D1	reg_res	0	R/W	Resets all control registers except the Feature Register. 0 = Reset Disabled. Normal operation. 1 = All control registers are reset to default state (except the Feature Register) identically after power-up. <b>Note:</b> The Digit Registers maintain their data.
D2	decode_sel	0	R/W	Selects display decoding. 0 = Enable Code-B decoding (see Table 10 on page 10). 1 = Enable HEX decoding (see Table 11 on page 11).
D3	spi_en	0	R/W	Enables the SPI-compatible interface. 0 = Disable SPI-compatible interface (AS1106 only). 1 = Enable the SPI-compatible interface (AS1106 only). <b>Note:</b> The SPI-compatible interface is always enabled in the AS1107.
D4	blink_en	0	R/W	Enables blinking. 0 = Disable blinking. 1 = Enable blinking.
D5	blink_freq_sel	0	R/W	Sets blink with low frequency (with the internal oscillator enabled): 0 = Blink period typically is 1 second (0.5s on, 0.5s off). 1 = Blink period is 2 seconds (1s on, 1s off).
D6	sync	0	R/W	Synchronizes blinking on the rising edge of pin LOAD/CSN. The multiplex and blink timing counter is cleared on the rising edge of pin LOAD/CSN. By setting this bit in multiple AS1106/AS1107 devices, the blink timing can be synchronized across all the devices.
D7	blink_start	0	R/W	Start Blinking with display enabled phase. When bit D4 (blink_en) is set, bit D7 determines how blinking starts. 0 = Blinking starts with the display turned off. 1 = Blinking starts with the display turned on.

### 8.5.7 No-Op Register (0xX0)

The No-Op Register is used when multiple AS1106 or AS1107 devices are cascaded in order to support displays with more than 8 digits. The cascading must be done in such a way that all DOUT pins are connected to DIN of the next AS1106/AS1107 (see Figure 14 on page 16). The LOAD/CSN and CLK signals are connected to all devices.

For example, if five devices are cascaded, in order to perform a write operation to the fifth device, the write-command must be followed by four no-operation commands. When the LOAD/CSN signal goes high, all shift registers are latched. The first four devices will receive no-operation commands and only the fifth device will receive the intended operation command, and subsequently update its register.

## 9 Application Information

### 9.1 Supply Bypassing and Wiring

In order to achieve optimal performance the AS1106/AS1107 should be placed very close to the LED display to minimize effects of electromagnetic interference and wiring inductance.

Furthermore, it is recommended to connect a 10 $\mu$ F electrolytic and a 0.1 $\mu$ F ceramic capacitor between pins VDD and GND to avoid power supply ripple (see Figure 14 on page 16).

**Note:** Both GND pins must be connected to ground.

### 9.2 Selecting R<sub>SET</sub> Resistor Value and Using External Drivers

Brightness of the display segments is controlled via RSET. The current that flows between VDD and ISET defines the current that flows through the LEDs.

Segment current is about 200 times the current in ISET. Typical values for RSET for different segment currents, operating voltages, and LED voltage drop (VLED) are given in Tables 19 - 23. The maximum current the AS1106/AS1107 devices can drive is 40mA. If higher currents are needed, external drivers must be used, in which case it is no longer necessary that the devices drive high currents.

In cases where the devices only drive a few digits, Table 16 specifies the maximum currents, and RSET must be set accordingly.

**Note:** The display brightness can also be logically controlled (see Intensity Control Register (0xXA) on page 12).

Table 19. RSET vs. Segment Current and LED Forward Voltage, VDD = 2.7V

ISEG (mA)	VLED(V)	
	1.5	2.0
40	5k $\Omega$	4.4k $\Omega$
30	6.9k $\Omega$	5.9k $\Omega$
20	10.7k $\Omega$	9.6k $\Omega$
10	22.2k $\Omega$	20.7k $\Omega$

Table 20. RSET vs. Segment Current and LED Forward Voltage, VDD = 3.3V

ISEG (mA)	VLED(V)		
	1.5	2.0	2.5
40	6.7k $\Omega$	6.4k $\Omega$	5.7k $\Omega$
30	9.1k $\Omega$	8.8k $\Omega$	8.1k $\Omega$
20	13.9k $\Omega$	13.3k $\Omega$	12.6k $\Omega$
10	28.8k $\Omega$	27.7k $\Omega$	26k $\Omega$

Table 21. RSET vs. Segment Current and LED Forward Voltage, VDD = 3.6V

ISEG (mA)	VLED(V)			
	1.5	2.0	2.5	3.0
40	7.5k $\Omega$	7.2k $\Omega$	6.6k $\Omega$	5.5k $\Omega$
30	10.18k $\Omega$	9.8k $\Omega$	9.2k $\Omega$	7.5k $\Omega$
20	15.6k $\Omega$	15k $\Omega$	14.3k $\Omega$	13k $\Omega$
10	31.9k $\Omega$	31k $\Omega$	29.5k $\Omega$	27.3k $\Omega$

Table 22. RSET vs. Segment Current and LED Forward Voltage, VDD = 4.0V

ISEG (mA)	VLED(V)				
	1.5	2.0	2.5	3.0	3.5
40	8.6k $\Omega$	8.3k $\Omega$	7.9k $\Omega$	7.6k $\Omega$	5.2k $\Omega$
30	11.6k $\Omega$	11.2k $\Omega$	10.8k $\Omega$	9.9k $\Omega$	7.8k $\Omega$
20	17.7k $\Omega$	17.3k $\Omega$	16.6k $\Omega$	15.6k $\Omega$	13.6k $\Omega$
10	36.89k $\Omega$	35.7k $\Omega$	34.5k $\Omega$	32.5k $\Omega$	29.1k $\Omega$



Table 23. RSET vs. Segment Current and LED Forward Voltage,  $V_{DD} = 5.0V$ 

ISEG (mA)	VLED (V)					
	1.5	2.0	2.5	3.0	3.5	4.0
40	11.35k $\Omega$	11.12k $\Omega$	10.84k $\Omega$	10.49k $\Omega$	10.2k $\Omega$	9.9k $\Omega$
30	15.4k $\Omega$	15.1k $\Omega$	14.7k $\Omega$	14.4k $\Omega$	13.6k $\Omega$	13.1k $\Omega$
20	23.6k $\Omega$	23.1k $\Omega$	22.6k $\Omega$	22k $\Omega$	21.1k $\Omega$	20.2k $\Omega$
10	48.9k $\Omega$	47.8k $\Omega$	46.9k $\Omega$	45.4k $\Omega$	43.8k $\Omega$	42k $\Omega$

### 9.3 Calculating the Power Dissipation

The upper limit for power dissipation (PD) for the AS1106/AS1107 is determined from the following equation:

$$PD = (V_{DD} \times 1mA) + (V_{DD} - V_{LED})(DUTY \times I_{SEG} \times N) \quad (EQ 1)$$

**Where:**

$V_{DD}$  is the supply voltage.

$DUTY$  is the duty cycle set by intensity register (page 12).

$N$  is the number of segments driven (worst case is 8)

$V_{LED}$  is the LED forward voltage

$I_{SEG}$  = segment current set by RSET

**Dissipation Example:**

$$I_{SEG} = 40mA, N = 8, DUTY = 31/32, V_{LED} = 1.8V \text{ at } 40mA, V_{DD} = 5.25V \quad (EQ 2)$$

$$PD = 5.25V(1mA) + (5.25V - 1.8V)(31/32 \times 40mA \times 8) = 1.075W \quad (EQ 3)$$

Thus, for a PDIP package  $\Theta_{JA} = +75^{\circ}C/W$  (from Table 24), the maximum allowed  $T_{AMB}$  is given by:

$$T_{J,MAX} = T_{AMB} + PD \times \Theta_{JA} = 150^{\circ}C = T_{AMB} + 1.07W \times 75^{\circ}C/W \quad (EQ 4)$$

**Where:**

$T_{AMB} = +69.4^{\circ}C$ .

The  $T_{AMB}$  limit for SO Packages in the dissipation example above is  $+58.6^{\circ}C$ .

Table 24. Package Thermal Data

Package	Thermal Resistance ( $\Theta_{JA}$ )
24 Wide SOIC	+85 $^{\circ}C/W$

## 9.4 8x8 LED Dot Matrix Driver

The application example in Figure 14 shows the AS1106 as an 8x8 LED dot matrix driver.

The LED columns have common cathodes and are connected to the DIG0:7 outputs. The rows are connected to the segment drivers. Each of the 64 LEDs can be addressed separately. The columns are selected via the digits as listed in Table 7 on page 9.

The Decode Enable Register (see page 10) must be set to '00000000' as described in Table 9 on page 10. Single LEDs in a column can be addressed as described in Table 12 on page 11, where bit D0 corresponds to segment G and bit D7 corresponds to segment DP.

**Note:** For a multiple-digit dot matrix, multiple AS1106 devices must be cascaded.

Figure 14. Application Example as LED Dot Matrix Driver

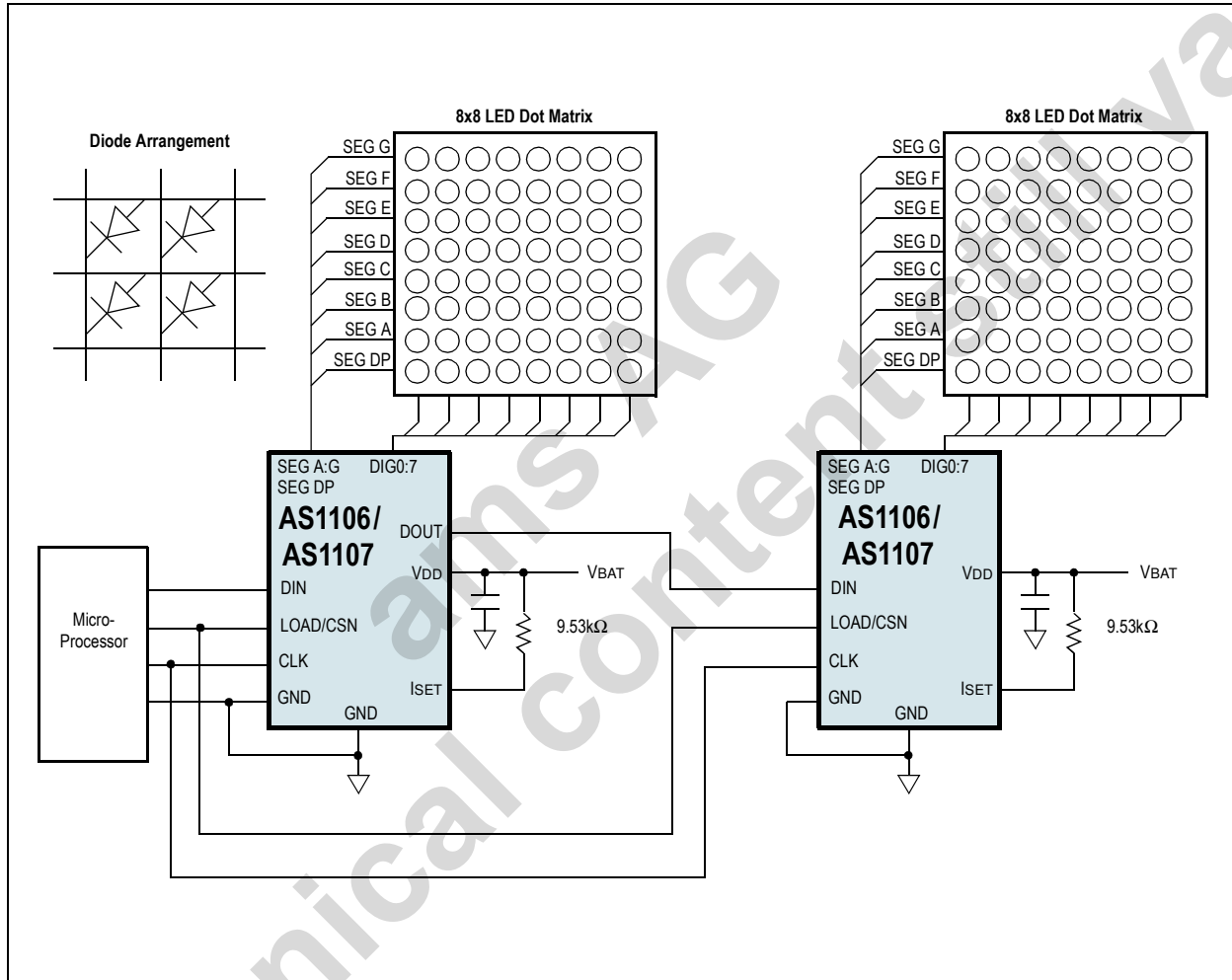

## 9.5 Cascading Drivers

The example in Figure 14 drives 2 dot matrix digits using a 4-wire microprocessor interface. All Scan-Limit Registers should be set to the same value so that one display will not appear brighter than the other.

For example, to display 12 digits, set both Scan-Limit Registers to display 6 digits so that both displays have a 1/6 duty cycle per digit. If 11 digits are needed, set both Scan-Limit Registers to display 6 digits and leave one digit unconnected. Otherwise, if one driver is set to display 6 digits and the other to display 5 digits one display will appear brighter because its duty cycle per digit will be 1/5 and the other display's duty cycle will be 1/6.

**Note:** Refer to No-Op Register (0xX0) on page 13 for additional information.

## 10 Package Drawings and Markings

Figure 15. AS1106, AS1107 Marking



Table 25. Packaging Code

YY	WW	Q	ZZ
last two digits of the current year	manufacturing week	plant identifier	free choice / traceability code

Figure 16. SOIC 24-pin Package

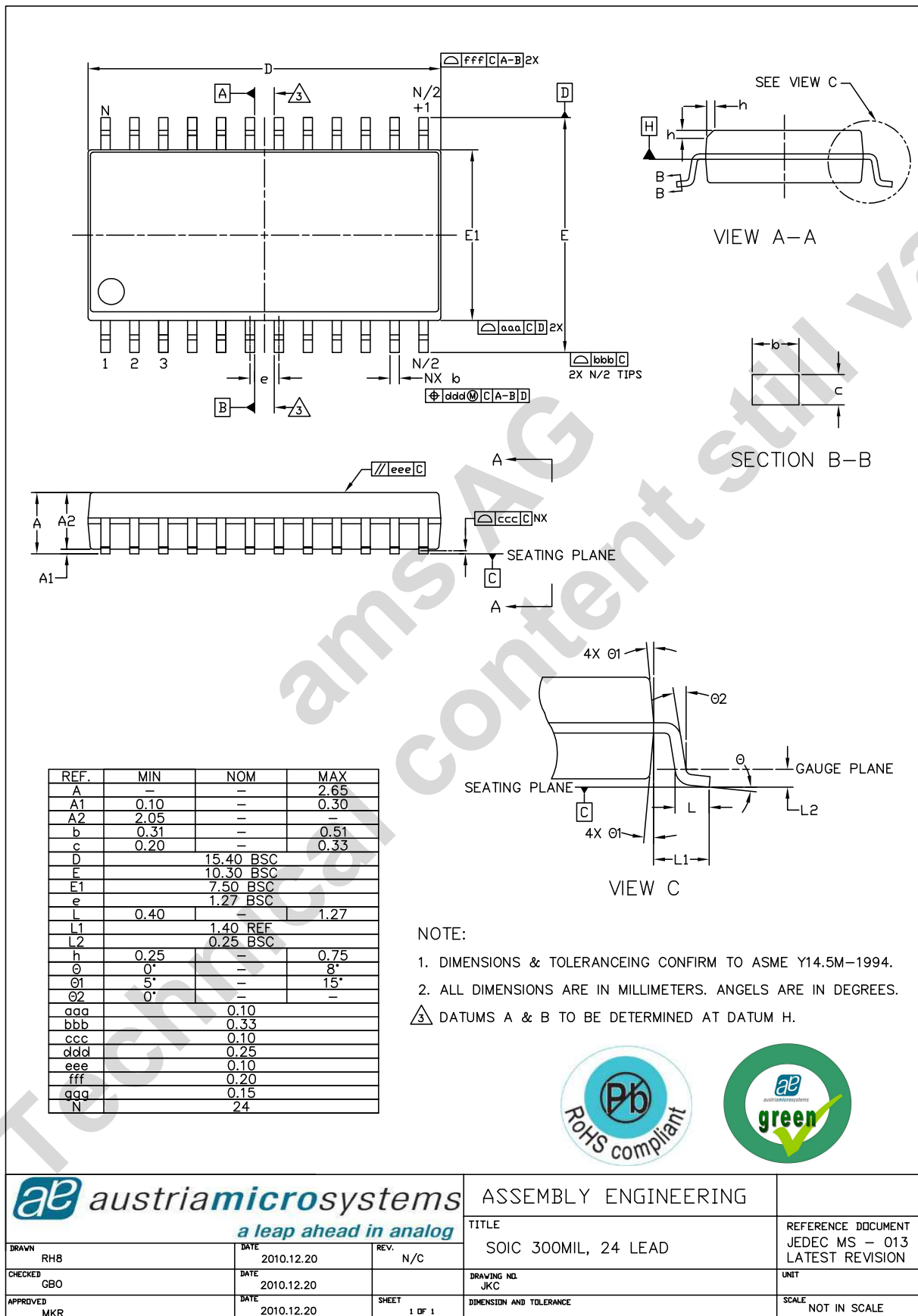

austriamicrosystems  
a leap ahead in analog

DRAWN RH8		DATE 2010.12.20	REV. N/C	ASSEMBLY ENGINEERING	
CHECKED GBO		DATE 2010.12.20		TITLE SOIC 300MIL, 24 LEAD	REFERENCE DOCUMENT JEDEC MS - 013 LATEST REVISION
APPROVED MKR		DATE 2010.12.20	SHEET 1 OF 1	DIMENSION AND TOLERANCE	SCALE NOT IN SCALE

## 11 Ordering Information

The AS1106 and AS1107 are available as the standard products shown in [Table 26](#).

Table 26. Ordering Information

Ordering Code	Marking	Description	Temperature Range	Delivery Form	Package
AS1106WL	AS1106WL	8-Digit LED Display Drivers	0 to +70°C	Tubes	SOIC 24-pin
AS1106WL-T	AS1106WL	8-Digit LED Display Drivers	0 to +70°C	Tape and Reel	SOIC 24-pin
AS1106WE	AS1106WE	8-Digit LED Display Drivers	-40 to +85°C	Tubes	SOIC 24-pin
AS1106WE-T	AS1106WE	8-Digit LED Display Drivers	-40 to +85°C	Tape and Reel	SOIC 24-pin
AS1107WL	AS1107WL	8-Digit LED Display Drivers	-40 to +85°C	Tubes	SOIC 24-pin
AS1107WL-T	AS1107WL	8-Digit LED Display Drivers	-40 to +85°C	Tape and Reel	SOIC 24-pin

**Note:** All products are RoHS compliant and austriamicrosystems green.

Buy our products or get free samples online at ICdirect: <http://www.austriamicrosystems.com/ICdirect>

Technical Support is found at <http://www.austriamicrosystems.com/Technical-Support>

For further information and requests, please contact us <mailto:sales@austriamicrosystems.com>  
or find your local distributor at <http://www.austriamicrosystems.com/distributor>

## Copyrights

Copyright © 1997-2012, austriamicrosystems AG, Tobelbaderstrasse 30, 8141 Unterpremstaetten, Austria-Europe. Trademarks Registered ©. All rights reserved. The material herein may not be reproduced, adapted, merged, translated, stored, or used without the prior written consent of the copyright owner.

All products and companies mentioned are trademarks or registered trademarks of their respective companies.

## Disclaimer

Devices sold by austriamicrosystems AG are covered by the warranty and patent indemnification provisions appearing in its Term of Sale. austriamicrosystems AG makes no warranty, express, statutory, implied, or by description regarding the information set forth herein or regarding the freedom of the described devices from patent infringement. austriamicrosystems AG reserves the right to change specifications and prices at any time and without notice. Therefore, prior to designing this product into a system, it is necessary to check with austriamicrosystems AG for current information. This product is intended for use in normal commercial applications. Applications requiring extended temperature range, unusual environmental requirements, or high reliability applications, such as military, medical life-support or life-sustaining equipment are specifically not recommended without additional processing by austriamicrosystems AG for each application. For shipments of less than 100 parts the manufacturing flow might show deviations from the standard production flow, such as test flow or test location.

The information furnished here by austriamicrosystems AG is believed to be correct and accurate. However, austriamicrosystems AG shall not be liable to recipient or any third party for any damages, including but not limited to personal injury, property damage, loss of profits, loss of use, interruption of business or indirect, special, incidental or consequential damages, of any kind, in connection with or arising out of the furnishing, performance or use of the technical data herein. No obligation or liability to recipient or any third party shall arise or flow out of austriamicrosystems AG rendering of technical or other services.



## Contact Information

### Headquarters

austriamicrosystems AG  
Tobelbaderstrasse 30  
A-8141 Unterpremstaetten, Austria

Tel: +43 (0) 3136 500 0  
Fax: +43 (0) 3136 525 01

For Sales Offices, Distributors and Representatives, please visit:

<http://www.austriamicrosystems.com/contact>