



Chipsmall Limited consists of a professional team with an average of over 10 year of expertise in the distribution of electronic components. Based in Hongkong, we have already established firm and mutual-benefit business relationships with customers from,Europe,America and south Asia,supplying obsolete and hard-to-find components to meet their specific needs.

With the principle of “Quality Parts,Customers Priority,Honest Operation,and Considerate Service”,our business mainly focus on the distribution of electronic components. Line cards we deal with include Microchip,ALPS,ROHM,Xilinx,Pulse,ON,Everlight and Freescale. Main products comprise IC,Modules,Potentiometer,IC Socket,Relay,Connector.Our parts cover such applications as commercial,industrial, and automotives areas.

We are looking forward to setting up business relationship with you and hope to provide you with the best service and solution. Let us make a better world for our industry!



## Contact us

Tel: +86-755-8981 8866 Fax: +86-755-8427 6832

Email & Skype: info@chipsmall.com Web: www.chipsmall.com

Address: A1208, Overseas Decoration Building, #122 Zhenhua RD., Futian, Shenzhen, China



# AS1369

## 200mA Ultra-Compact Low Dropout Regulator

### 1 General Description

The AS1369 is an ultra compact high-performance low-dropout 200mA voltage regulator designed for use with very-low ESR output capacitors. The device can deliver superior performance in all specifications critical to battery-powered designs, and is perfectly suited for mobile phones, PDAs, MP3 players, and other battery powered devices.

The AS1369 is working with small input and output capacitor of only 0.47 $\mu$ F offering PSRR of 72dB typical and a noise level of 30 $\mu$ V<sub>RMS</sub>.

Typical quiescent current is around 25 $\mu$ A while in shutdown the AS1369 requires less than 0.1 $\mu$ A quiescent current.

Regulation performance is excellent even under low dropout conditions, when the power transistor has to operate in linear mode.

The AS1369 offers excellent low-noise performance requiring no external bypass capacitance.

Multiple output voltage options between 1.2 and 5.0V in 100mV steps are available and the the minimum input voltage is as low as 2.0V (depending on the output voltage version), so the component can be used with the coming new battery technologies.

The AS1369 is available in a 4-bump WL-CSP package.

### 2 Key Features

- Low Dropout Voltage: typ. 40mV @ 100mA
- 200mA High Maximum Load Current
- 2.0V to 5.5V Input Voltage
- 1.2V to 5.0V Output Voltage (in 100mV steps)
- High Accuracy:  $\pm 2\%$  Over Temperature
- Thermal and Over Current Protection
- 25 $\mu$ A Quiescent Current
- <0.1 $\mu$ A Standby Current
- High PSRR: 72dB @ 1kHz
- No Noise Bypass Capacitor Required
- Low Noise: 30 $\mu$ V<sub>RMS</sub>
- Enable Pin
- Package: 4-bump WL-CSP 0.5mm pitch

### 3 Applications

The device is ideal for mobile communication, battery powered systems and any electronic equipment.

Figure 1. AS1369 - Block Diagram

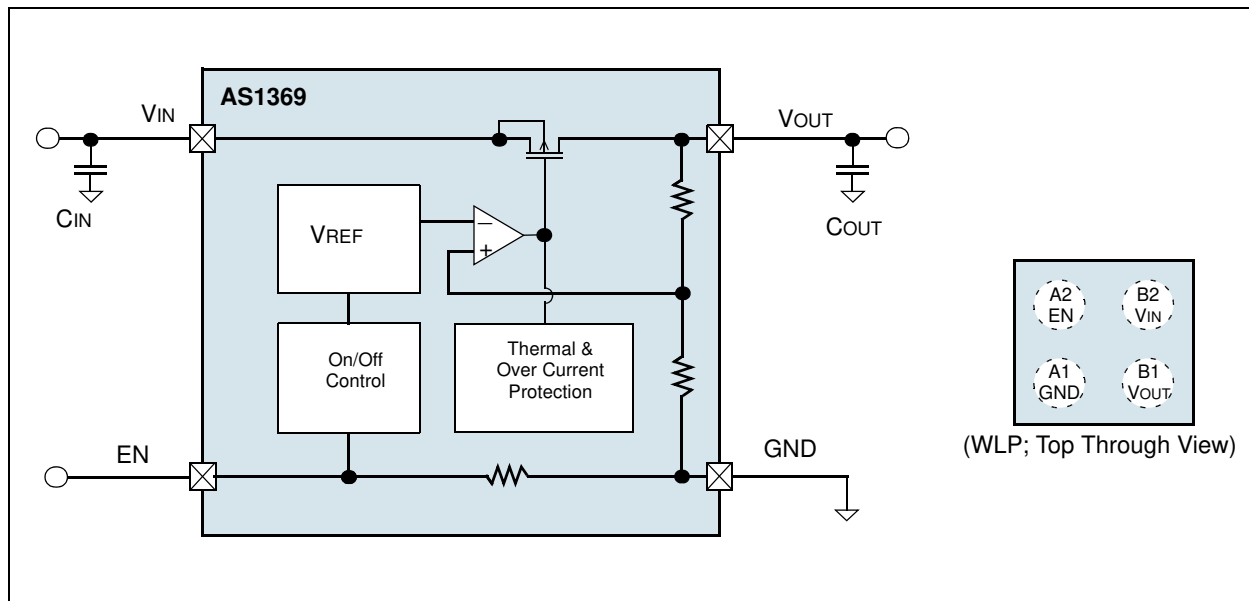

## 4 Pinout

### Pin Assignments

Figure 2. Pin Assignments (Top View)

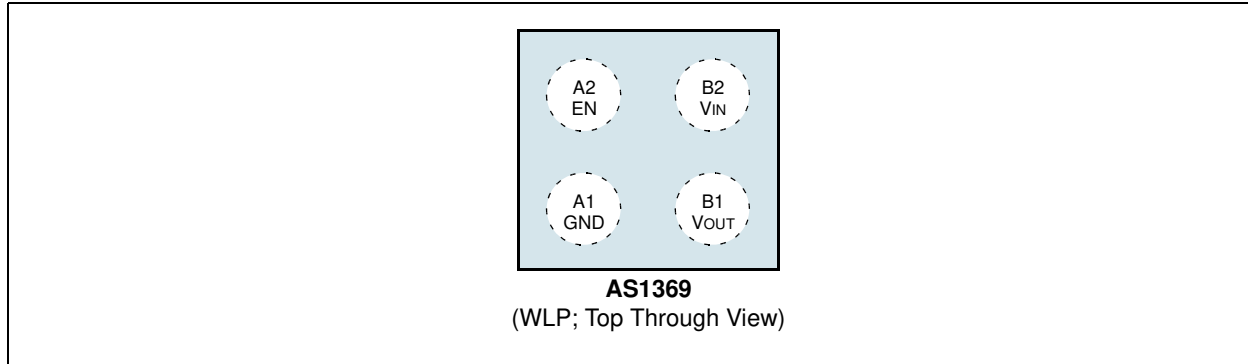

### Pin Descriptions

Table 1. Pin Descriptions

Name	WLP	Description
GND	A1	<b>Ground</b>
EN	A2	<b>Logic-High Enable Input.</b> $V_{IH} \geq 1.2V$ : VOUT is enabled. $V_{IH} \leq 0.4V$ : VOUT is disabled. <b>Note:</b> This pin is internally pulled down and must not float.
VOUT	B1	<b>Regulated Output Voltage</b>
VIN	B2	<b>Input Voltage</b>

## 5 Absolute Maximum Ratings

Stresses beyond those listed in [Table 2](#) may cause permanent damage to the device. These are stress ratings only, and functional operation of the device at these or any other conditions beyond those indicated in [Electrical Characteristics on page 4](#) is not implied. Exposure to absolute maximum rating conditions for extended periods may affect device reliability.

Table 2. Absolute Maximum Ratings

Parameter	Min	Max	Units	Comments
Input Supply Voltage	-0.3	+7	V	
Shutdown Input Voltage	-0.3	+7	V	
Output Voltage	-0.3	+7	V	
I <sub>OUT</sub>				Short-circuit protected.
Input/Output Voltage <sup>1</sup>	-0.3	+7	V	
Power Dissipation <sup>2</sup>		360	mW	Internally limited. Mounted on PCB.
Operating Junction Temperature	-40	+125	°C	
Storage Temperature Range	-65	+150	°C	
ESD		2	kV	HBM MIL-Std. 883E 3015.7 methods
		500	V	CDM JESD22-C101C methods
Latch-Up	-100	+100	mA	JEDEC 78
Package Body Temperature		+260	°C	The reflow peak soldering temperature (body temperature) specified is in accordance with IPC/JEDEC J-STD-020C "Moisture/Reflow Sensitivity Classification for Non-Hermetic Solid State Surface Mount Devices". The lead finish for Pb-free leaded packages is matte tin (100% Sn).

- The output PNP structure contains a diode between pins V<sub>IN</sub> and V<sub>OUT</sub> that is normally reverse-biased. reversing the polarity of pins V<sub>IN</sub> and V<sub>OUT</sub> will activate this diode.
- The maximum allowable power dissipation is a function of the maximum junction temperature (T<sub>J(MAX)</sub>), the junction-to-ambient thermal resistance (Θ<sub>JA</sub>), and the ambient temperature (T<sub>AMB</sub>). The maximum allowable power dissipation at any ambient temperature is calculated as:

$$P_{(MAX)} = (T_{J(MAX)} - (T_{AMB})) / \Theta_{JA} \quad (EQ 1)$$

**Where:**

The value of Θ<sub>JA</sub> for the WLP package is 345°C/W.

**Note:** Exceeding the maximum allowable dissipation will cause excessive device temperature and the regulator will go into thermal shutdown.

The AS1369 uses an internal protective structure against light influence. However, exposing the WLP package to direct light could cause device malfunction.

## 6 Electrical Characteristics

$T_{AMB} = -40$  to  $85^{\circ}\text{C}$ ,  $V_{IN} = V_{OUT(NOM)} + 0.5\text{V}$ ,  $C_{OUT} = C_{IN} = 0.47\mu\text{F}$ ,  $I_{OUT} = 1\text{mA}$ ,  $V_{IH} = 1.2\text{V}$  (unless otherwise specified)

Table 3. Electrical Characteristics

Symbol	Parameter	Condition	Min	Typ	Max	Unit
	Operational Voltage Range		2.0		5.5	V
	Input Undervoltage Lockout			1.8		V
	Accuracy	Over full $V_{IN}$ , $V_{OUT}$ , $T_{AMB} = 25^{\circ}\text{C}$ including line and load regulation	-0.7		+0.7	%
		Over full $V_{IN}$ , $V_{OUT}$ and temperature including line and load regulation	-2		+2	
$V_{DROP}$	Dropout Voltage <sup>1</sup>	$I_{OUT} = 50\text{mA}$		20	50	mV
		$I_{OUT} = 100\text{mA}$		40	100	
		$I_{OUT} = 150\text{mA}$		60	150	
		$I_{OUT} = 200\text{mA}$		80	200	
$\Delta V_{OUT}$	Line Regulation	$V_{IN} = V_{OUT(NOM)} + 0.5\text{V}$ to $5.5\text{V}$ , $V_{OUT} \geq 2.5\text{V}$		0.02	0.1	%/ $V$
		$V_{IN} = V_{OUT(NOM)} + 0.5\text{V}$ to $5.5\text{V}$ , $V_{OUT} < 2.5\text{V}$		0.02	0.2	
	Load Regulation	$I_{OUT} = 5$ to $100\text{mA}$		0.001	0.003	%/ $\text{mA}$
		$I_{OUT} = 5$ to $200\text{mA}$		0.001	0.003	
$\frac{\Delta V_{OUT}}{\Delta T_{AMB}}$	Output voltage/temperature	$I_{OUT} = 5\text{mA}$		50		ppm/ $^{\circ}\text{C}$
	Output current	Maximum output current	210			mA
$I_Q$	Quiescent current	$I_{LOAD} = 0\text{mA}$		25	50	$\mu\text{A}$
		$I_{LOAD} = 200\text{mA}$		35	60	$\mu\text{A}$
$I_{SHDN}$	Standby current	In Shutdown		5	500	nA
$t_{ON}$	Turn On Time <sup>2</sup>			30		$\mu\text{s}$
	PSRR	$I_{out} = 10\text{mA}$ , $f = 1\text{kHz}$ , $V_{OUT} = 1.5\text{V}$		72		dB
		$I_{out} = 10\text{mA}$ , $f = 100\text{kHz}$ , $V_{OUT} = 1.5\text{V}$		55		dB
		$I_{out} = 10\text{mA}$ , $f = 1\text{kHz}$ , $V_{OUT} = 2.8\text{V}$		80		dB
		$I_{out} = 10\text{mA}$ , $f = 100\text{kHz}$ , $V_{OUT} = 2.8\text{V}$		56		dB
	Load transient resp.	1 to 150mA, $T_{rise} = T_{fall} = 1\mu\text{s}$ , $C_{out} = C_{in} = 1\mu\text{F}$ , ESR load capacitor = 0		$\pm 65$		mV
eN	Output Noise Voltage	BW = 400Hz to 80kHz, $C_{OUT} = 1\mu\text{F}$ , $I_{OUT} = 30\text{mA}$		30		$\mu\text{V}_{RMS}$
$I_{EN}$	Enable Input Current	$V_{EN} = 0.4\text{V}$ , $V_{IN} = 5.5\text{V}$		$\pm 1$		$\mu\text{A}$
$V_{EN}$	Enable Input Logic Low	$V_{IN} = 2.0$ to $5.5\text{V}$ , $T_{AMB} = -40$ to $85^{\circ}\text{C}$			0.4	V
	Enable Input Logic High		1.2			
$I_{IN(start)}$	Startup Peak Current	$I_{OUT} = 0\text{mA}$		340		mA
$I_{SC}$	Short Circuit Current	$V_{OUT} = 0\text{V}$	210	350		mA
$T_{OFF}$	Temperature Shutdown	Temperature rising		160		$^{\circ}\text{C}$
		Hysteresis		20		

1. Dropout voltage is the input-to-output voltage difference at which the output voltage is 100mV below its nominal value (does not apply to input voltages below 2.0V).

2. Turn on time is time measured between the enable input just exceeding the  $V_{EN}$  high value and the output voltage just reaching 95% of its nominal value.

Figure 3. AC Line Regulation Input Voltage Test Signal

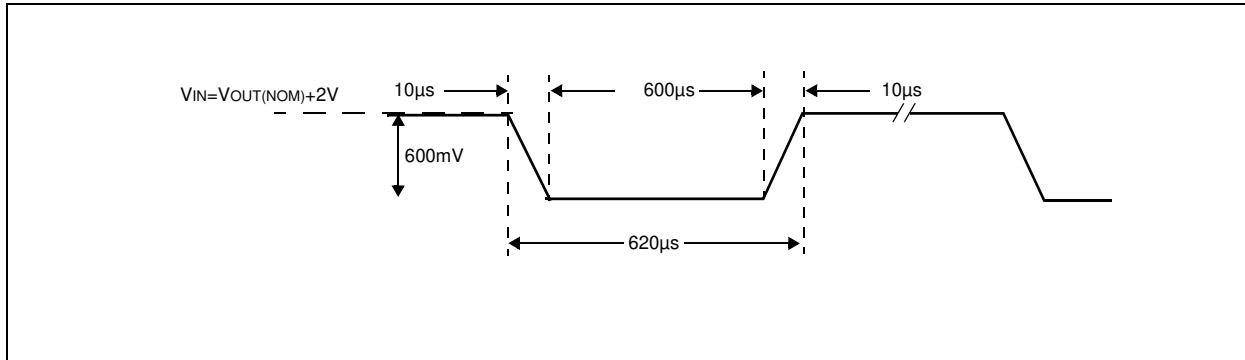
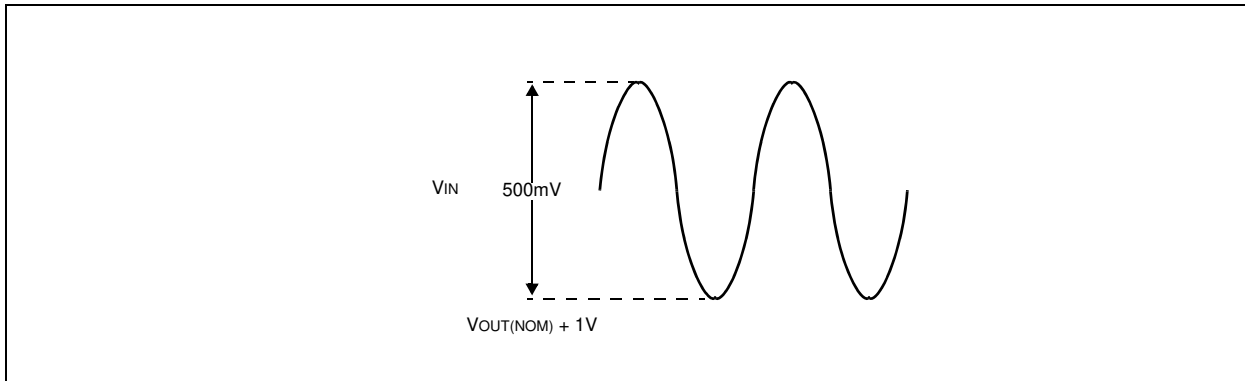

Figure 4. SVR Input Voltage Test Signal



## 7 Typical Operating Characteristics

$V_{IN} = V_{OUT} + 0.5V$ ,  $C_{IN} = C_{OUT} = 1\mu F$ ,  $T_{AMB} = 25^{\circ}C$  (unless otherwise specified).

Figure 5.  $\Delta V_{OUT}$  vs.  $V_{IN}$ ;  $V_{OUT(NOM)} = 1.5V$

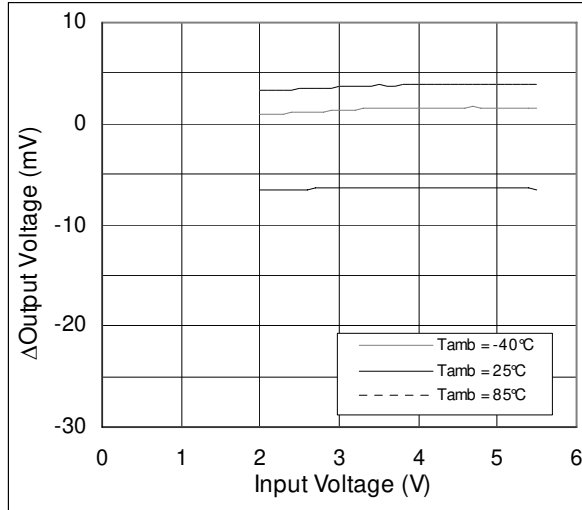

Figure 6.  $\Delta V_{OUT}$  vs.  $V_{IN}$ ;  $V_{OUT(NOM)} = 2.8V$

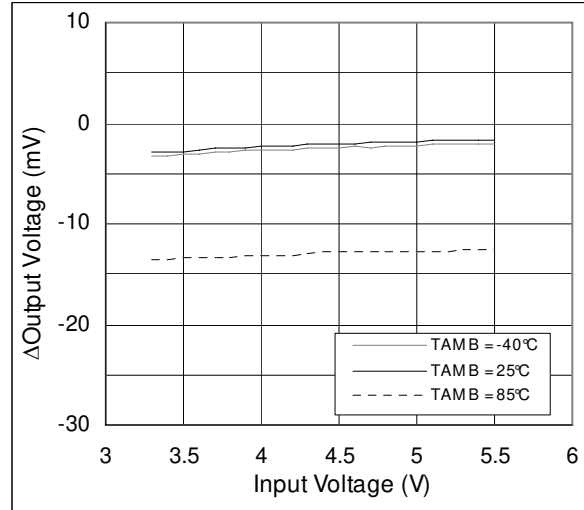

Figure 7.  $\Delta V_{OUT}$  vs.  $(V_{IN} - V_{OUT})$ ;  $T_{AMB} = -40^{\circ}C$

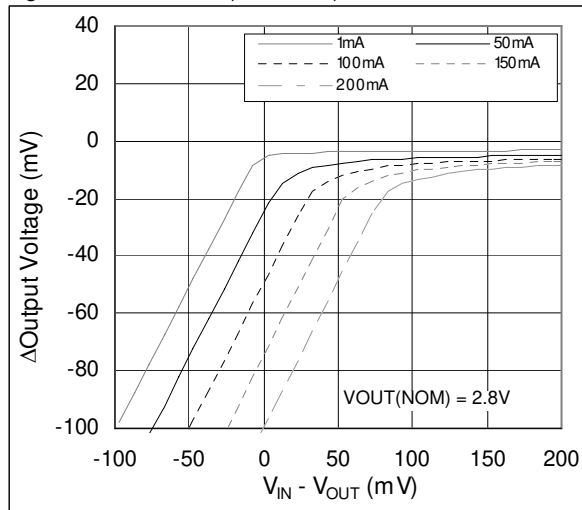

Figure 8.  $\Delta V_{OUT}$  vs.  $(V_{IN} - V_{OUT})$ ;  $T_{AMB} = +25^{\circ}C$

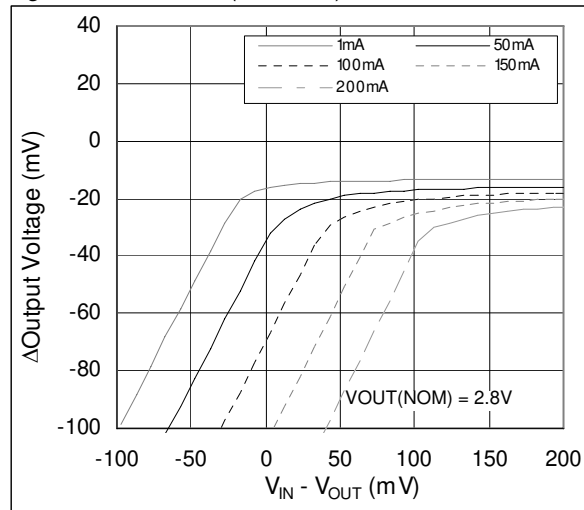

Figure 9.  $\Delta V_{OUT}$  vs.  $(V_{IN} - V_{OUT})$ ;  $T_{AMB} = +85^{\circ}C$

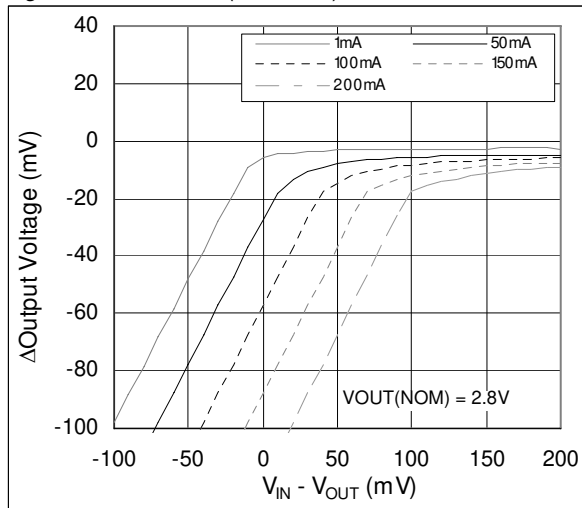

Figure 10. Dropout Voltage vs.  $I_{OUT}$ ;  $V_{OUT} = 2.8V$

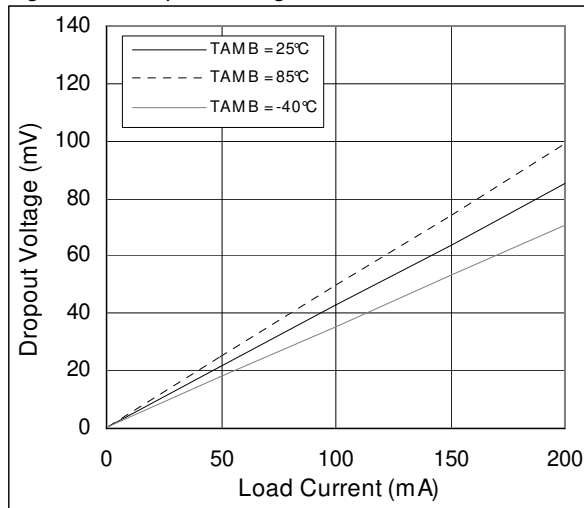

Figure 11.  $V_{OUT}$  vs.  $I_{OUT}$ ;  $V_{OUT(NOM)} = 1.5V$

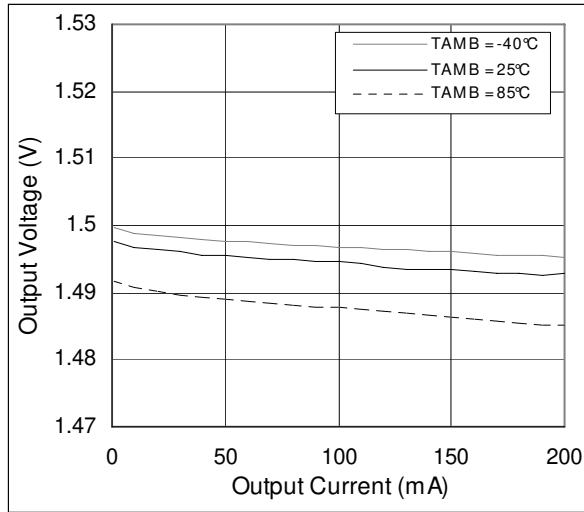

Figure 12.  $V_{OUT}$  vs.  $I_{OUT}$ ;  $V_{OUT(NOM)} = 2.8V$

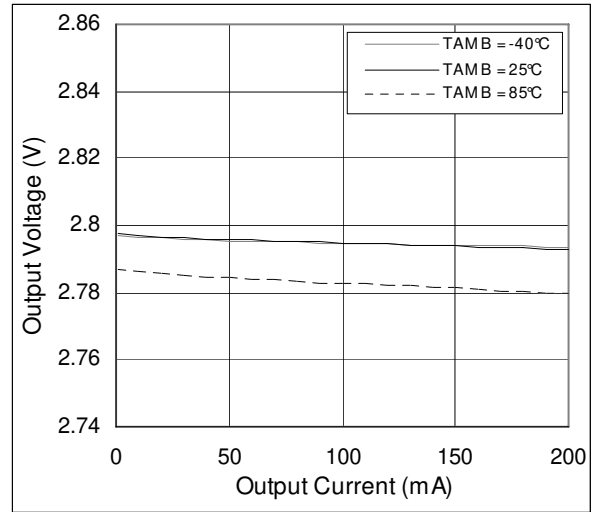

Figure 13.  $\Delta V_{OUT}$  vs.  $I_{OUT}$ ;  $V_{OUT(NOM)} = 1.5V$

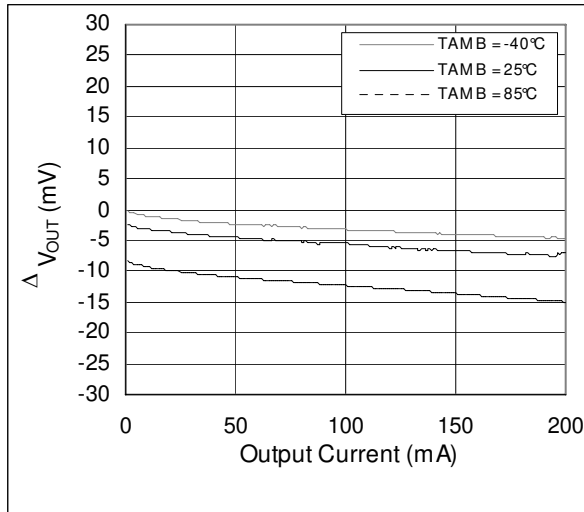

Figure 14.  $\Delta V_{OUT}$  vs.  $I_{OUT}$ ;  $V_{OUT(NOM)} = 2.8V$

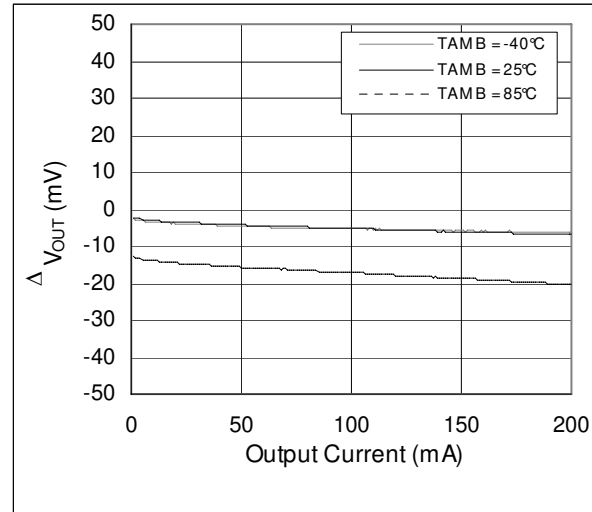

Figure 15.  $\Delta V_{OUT}$  vs. Temp.;  $V_{OUT(NOM)} = 1.5V$

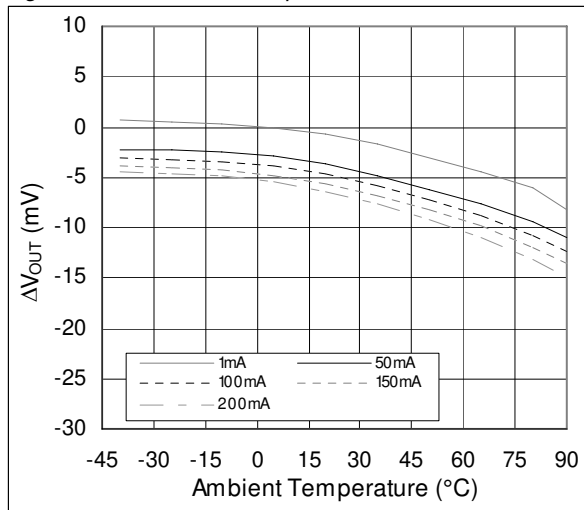

Figure 16.  $\Delta V_{OUT}$  vs. Temp.;  $V_{OUT(NOM)} = 2.8V$

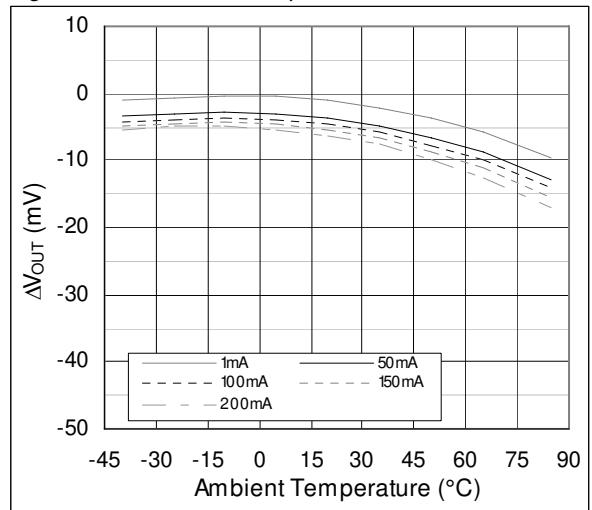



Figure 17. Dropout Voltage vs. Temp.;  $V_{OUT} = 2.8V$

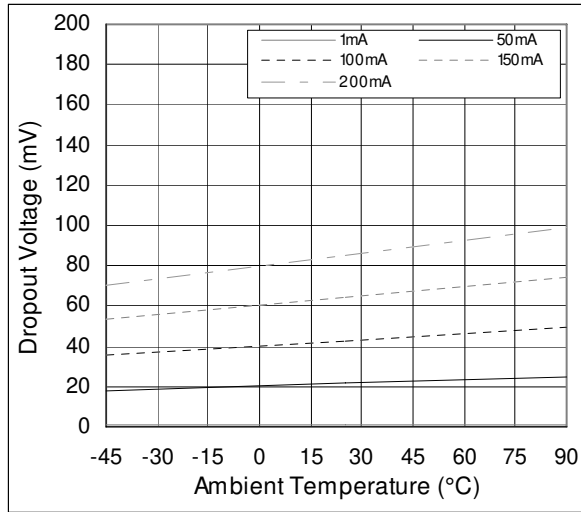

Figure 18.  $I_{OUT(MAX)}$  vs. Temp.

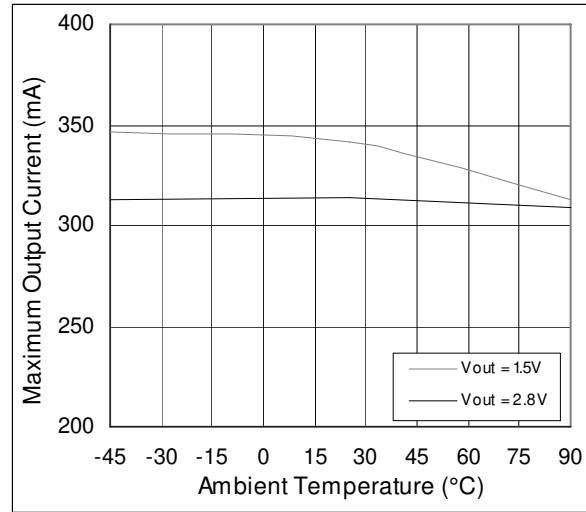

Figure 19. Quiescent Current vs.  $V_{IN}$

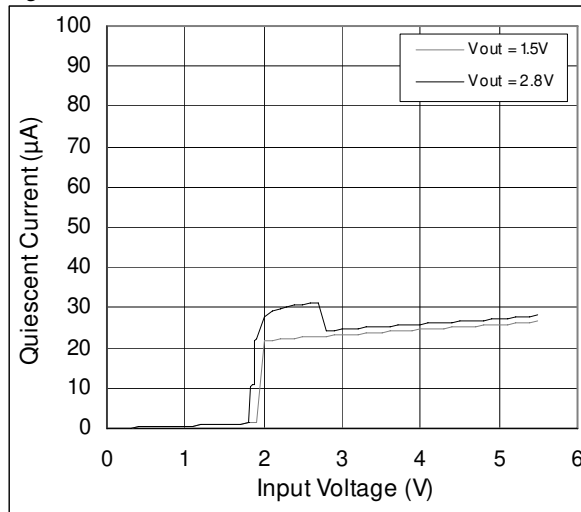

Figure 20. Standby Current vs.  $V_{IN}$

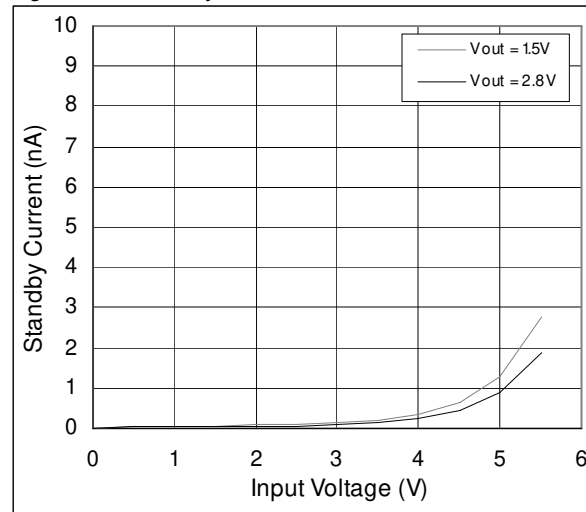

Figure 21. Ground Current vs.  $I_{OUT}$

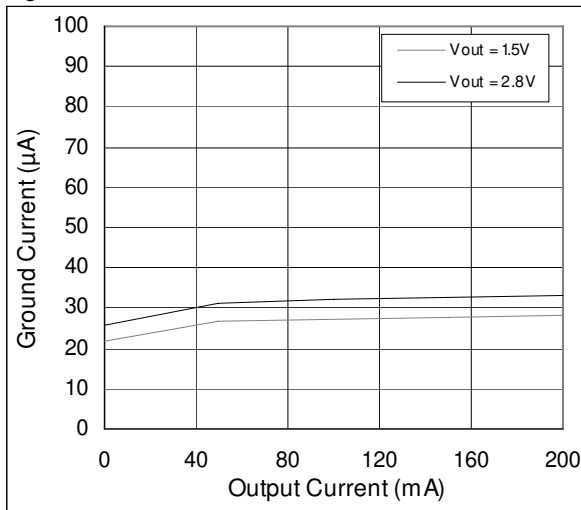

Figure 22. Quiescent Current vs. Temperature

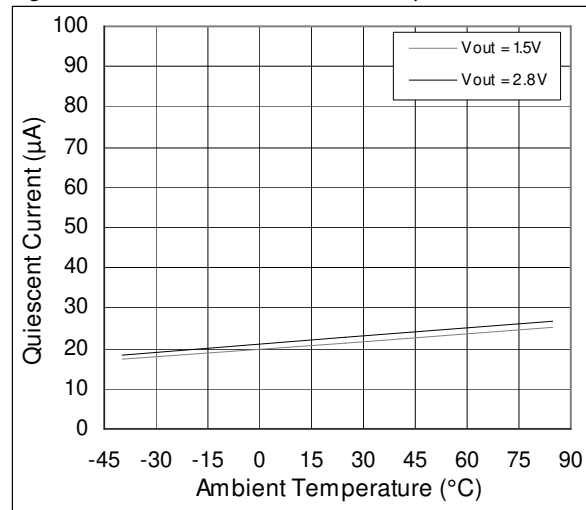

Figure 23. Ground Current vs. Temp.;  $V_{OUT} = 1.5V$

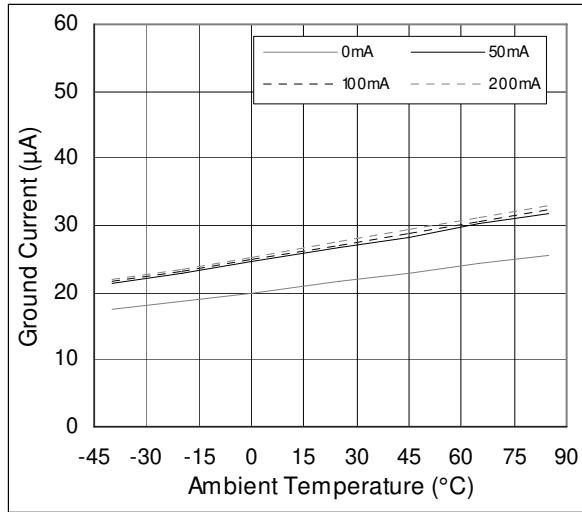

Figure 24. Ground Current vs. Temp.;  $V_{OUT} = 2.8V$

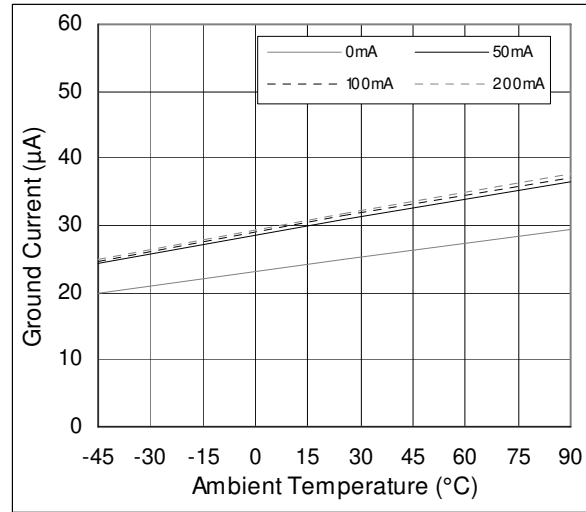

Figure 25.  $I_{EN}$  vs.  $V_{OUT}$ ;  $V_{OUT} = 1.5V$

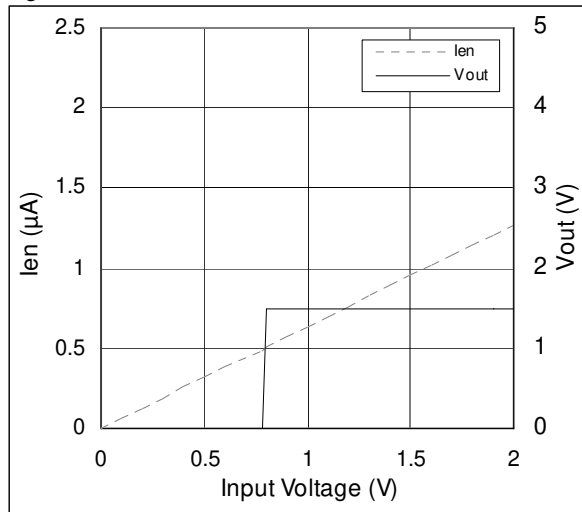

Figure 26.  $I_{EN}$  vs.  $V_{OUT}$ ;  $V_{OUT} = 2.8V$

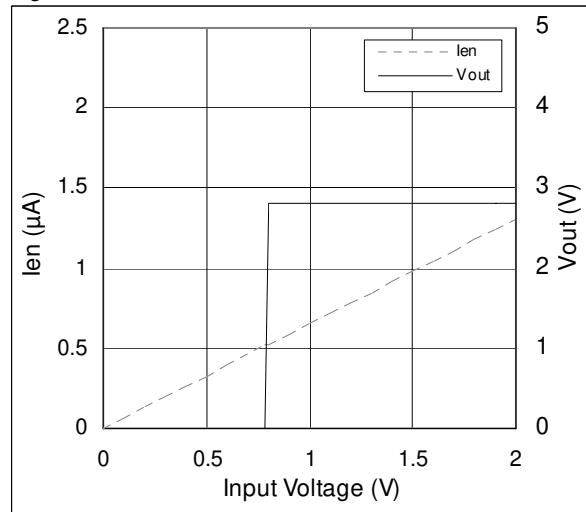

Figure 27.  $V_{EN}$  vs. Temperature

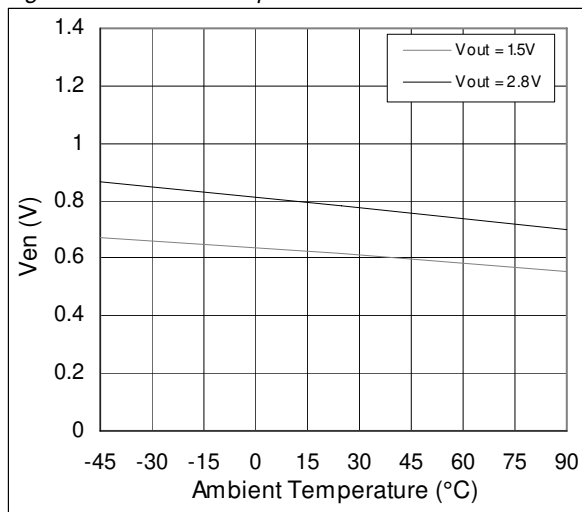

Figure 28.  $I_{EN}$  vs. Temperature

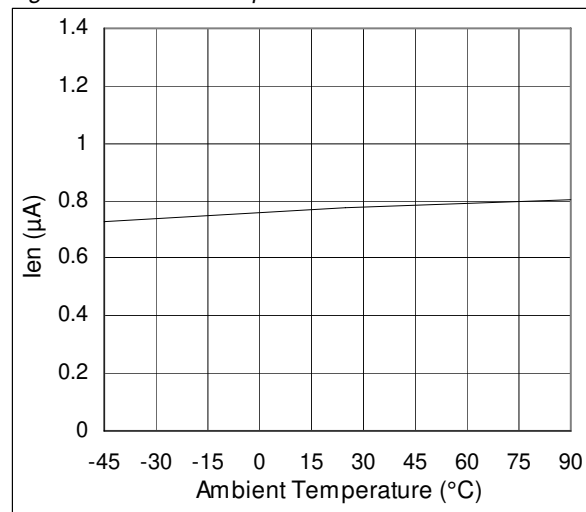

Figure 29. PSRR vs.  $V_{IN}-V_{OUT(NOM)}$ ,  $V_{OUT} = 1.5V$

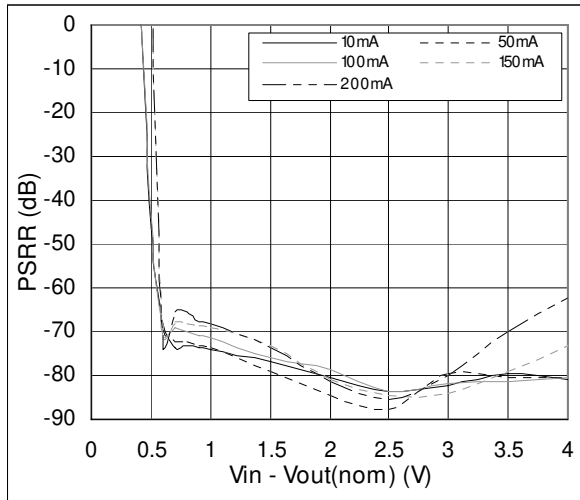

Figure 30. PSRR vs.  $V_{IN}-V_{OUT(NOM)}$ ,  $V_{OUT} = 2.8V$

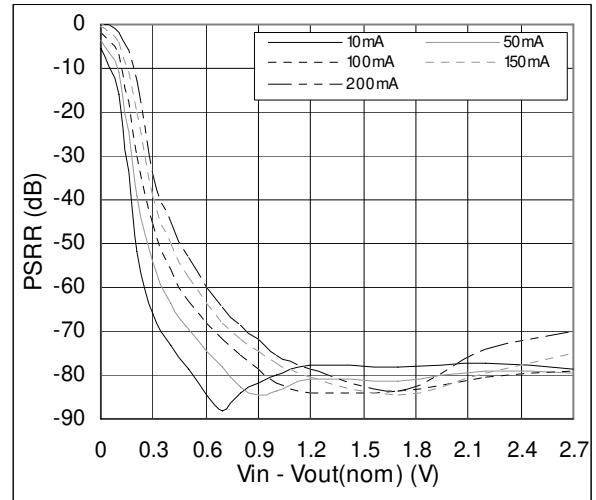

Figure 31. PSRR vs. Frequency,  $I_{OUT} = 10mA$

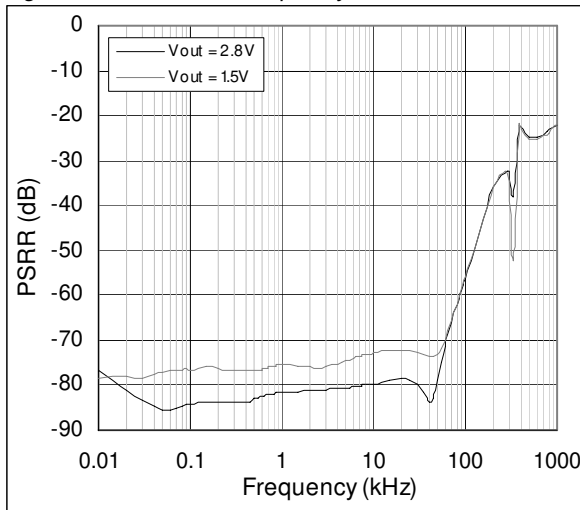

Figure 32. Spectral Noise vs. Frequency,  $I_{OUT} = 10mA$

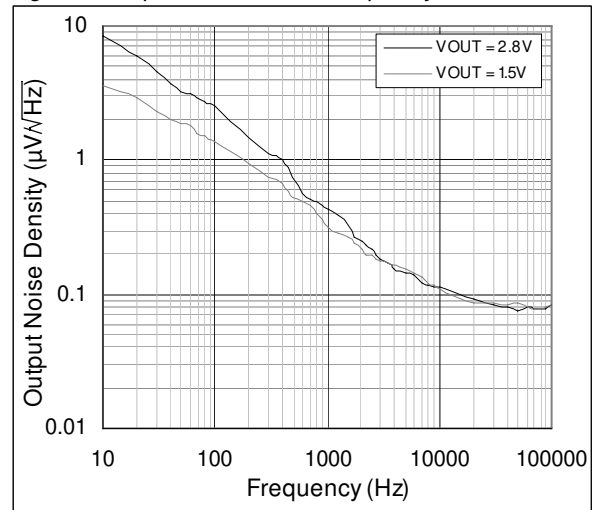

Figure 33. Voltage Noise vs.  $V_{OUT}$ ,  $I_{OUT} = 30mA$

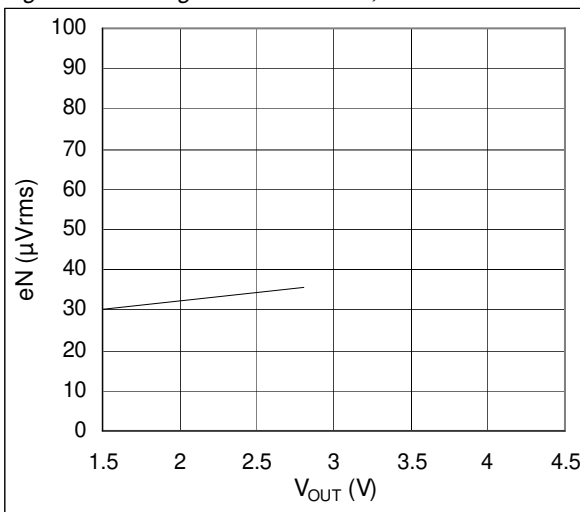

Figure 34. Line Transient Response;  $I_{OUT} = 50\text{mA}$ ,  $V_{OUT} = 1.5\text{V}$ ,  $V_{IN} = 3.5$  to  $2.9\text{V}$

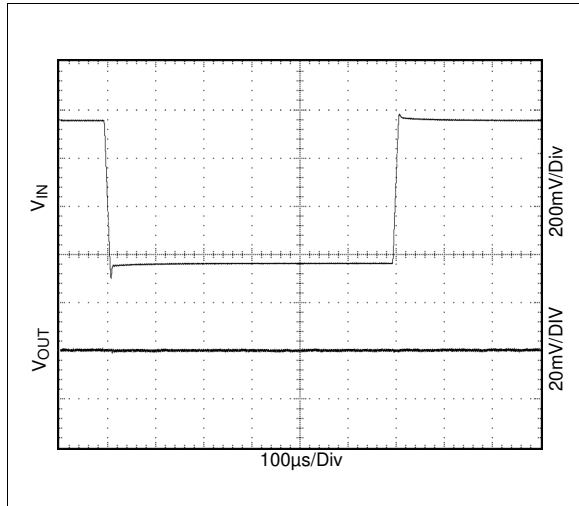

Figure 35. Line Transient Response;  $I_{OUT} = 50\text{mA}$ ,  $V_{OUT} = 2.8\text{V}$ ,  $V_{IN} = 4.8$  to  $4.2\text{V}$

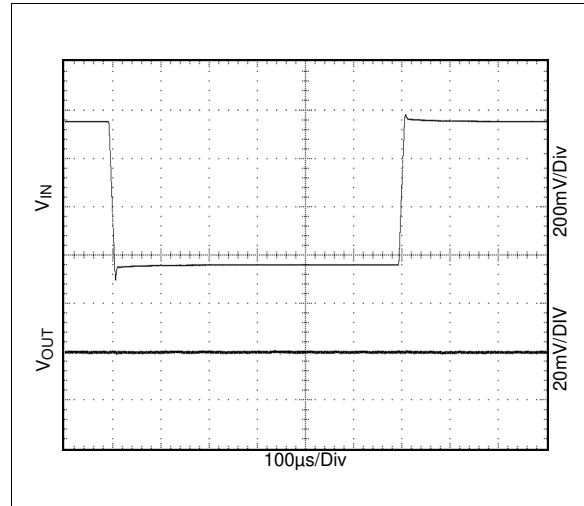

Figure 36. Line Transient Response;  $I_{OUT} = 100\text{mA}$ ,  $V_{OUT} = 1.5\text{V}$ ,  $V_{IN} = 3.5$  to  $2.9\text{V}$

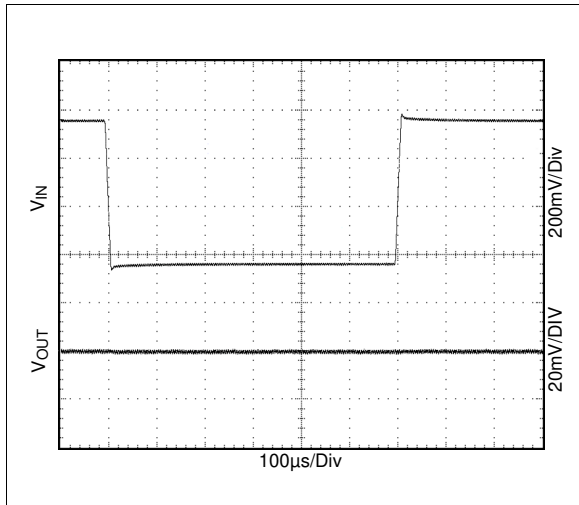

Figure 37. Line Transient Response;  $I_{OUT} = 100\text{mA}$ ,  $V_{OUT} = 2.8\text{V}$ ,  $V_{IN} = 4.8$  to  $4.2\text{V}$

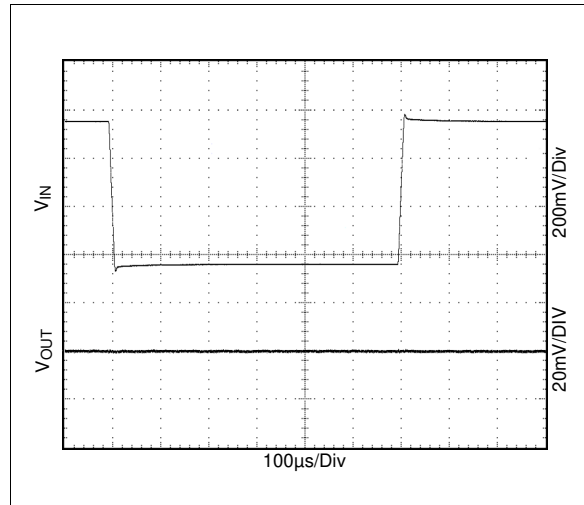

Figure 38. Line Transient Response;  $I_{OUT} = 200\text{mA}$ ,  $V_{OUT} = 1.5\text{V}$ ,  $V_{IN} = 3.5$  to  $2.9\text{V}$

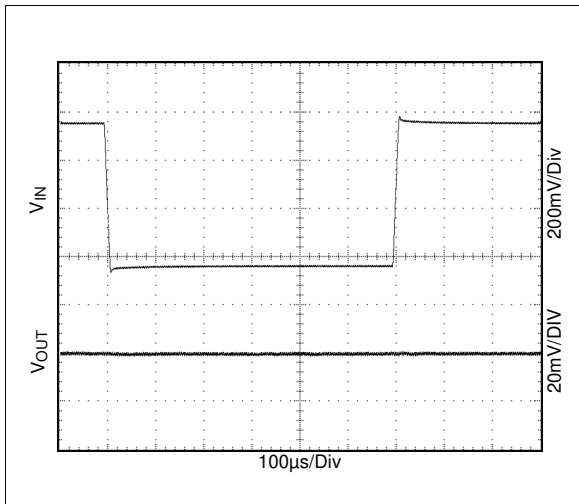

Figure 39. Line Transient Response;  $I_{OUT} = 200\text{mA}$ ,  $V_{OUT} = 2.8\text{V}$ ,  $V_{IN} = 4.8$  to  $4.2\text{V}$

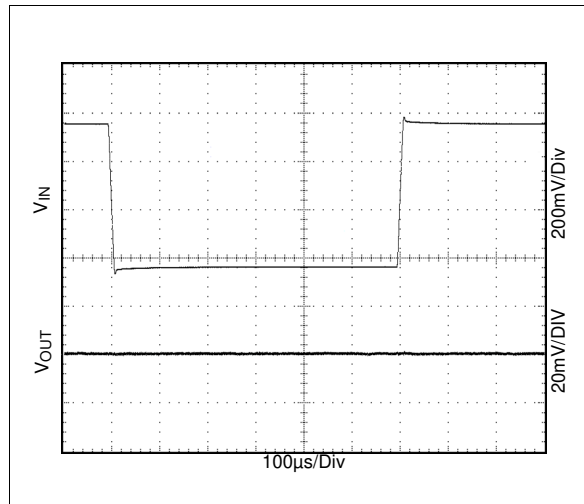

Figure 40. Load Transient;  $I_{OUT} = 0$  to  $150\text{mA}$   
 $V_{IN} = 2.0\text{V}$ ,  $V_{OUT} = 1.5\text{V}$

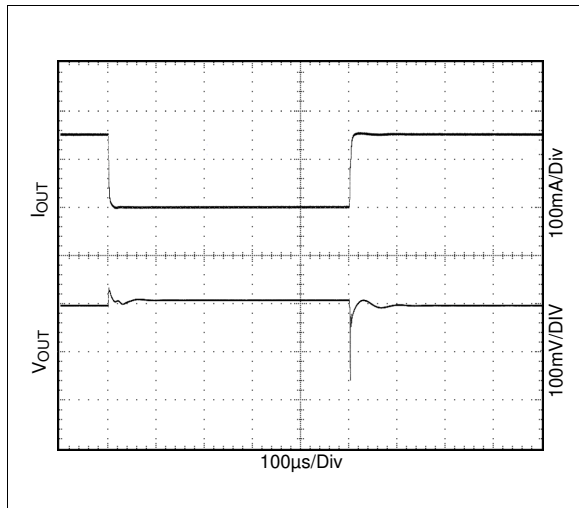

Figure 41. Load Transient;  $I_{OUT} = 0$  to  $150\text{mA}$   
 $V_{IN} = 3.3\text{V}$ ,  $V_{OUT} = 2.8\text{V}$

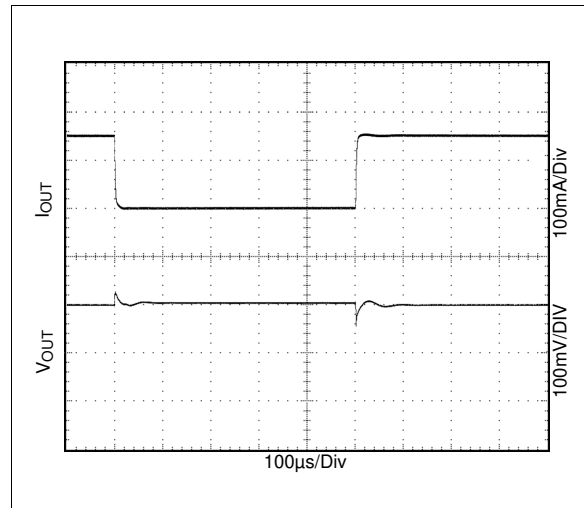

Figure 42. Load Transient;  $I_{OUT} = 0$  to  $150\text{mA}$   
 $V_{IN} = 3.0\text{V}$ ,  $V_{OUT} = 2.8\text{V}$ , in Dropout

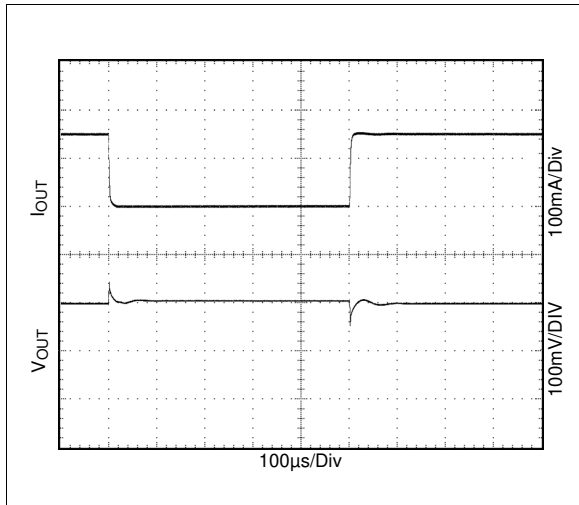

Figure 43. Load Transient;  $I_{OUT} = 1$  to  $150\text{mA}$   
 $V_{IN} = 3.0\text{V}$ ,  $V_{OUT} = 2.8\text{V}$ , in Dropout

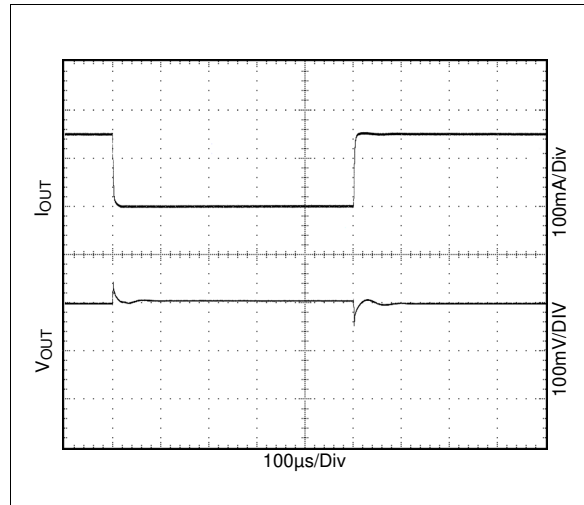

Figure 44. Startup

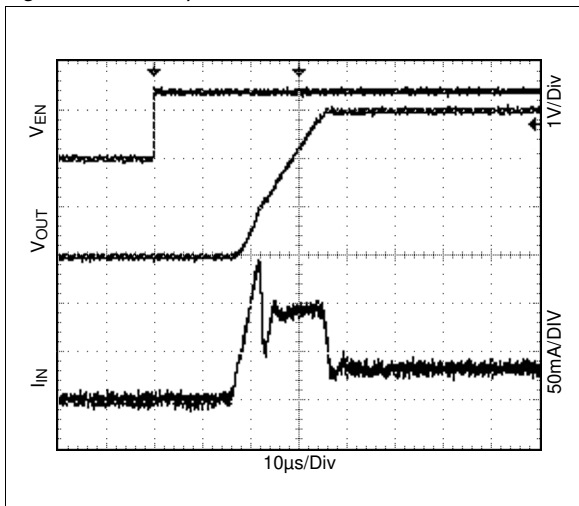
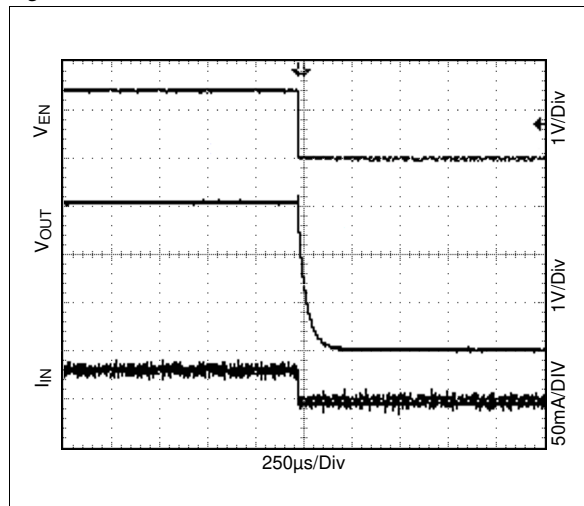
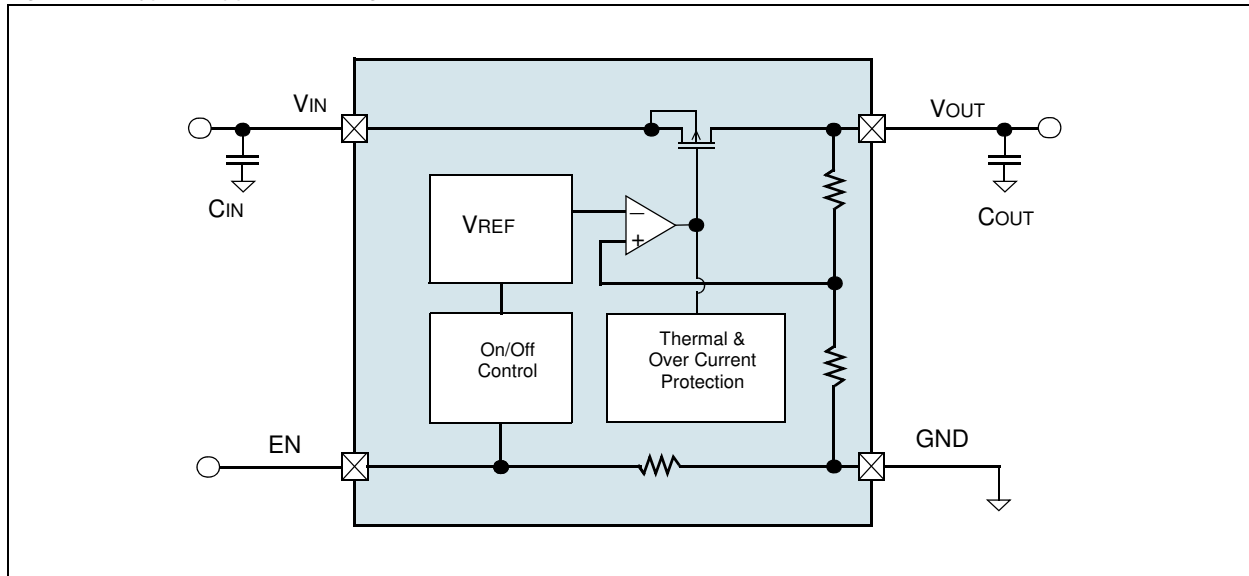

Figure 45. Shutdown



## 8 Typical Application

Figure 46. Typical Application Diagram



## 9 Package Drawings and Markings

The AS1369 is available in a 4-bump WL-CSP package.

Figure 47. 4-bump WL-CSP Package

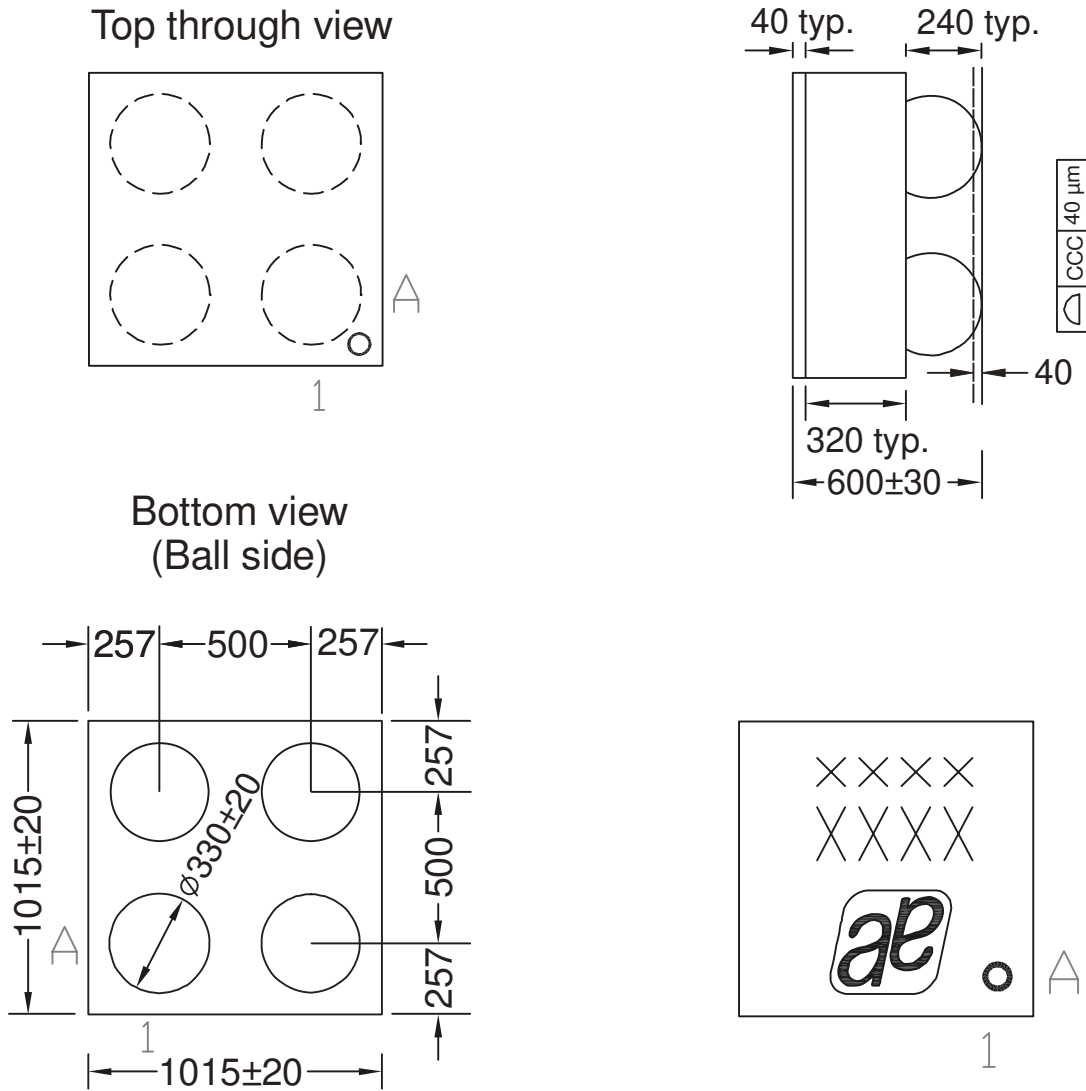

**Notes:**

1. All dimensions are in  $\mu\text{m}$ .

## 10 Ordering Information

The AS1369 is available as the standard versions listed in [Table 4](#). Other versions are available upon request. Contact austriamicrosystems, AG for more information.

Table 4. Ordering Information

Ordering Code	Marking	Output	Description	Delivery Form	Package
AS1369-BWLT-12	ASRW	1.2V	200mA Ultra-Compact Low Dropout Regulator	Tape and Reel	4-bump WL-CSP
AS1369-BWLT-13	ASRX	1.3V	200mA Ultra-Compact Low Dropout Regulator	Tape and Reel	4-bump WL-CSP
AS1369-BWLT-15	ASPZ	1.5V	200mA Ultra-Compact Low Dropout Regulator	Tape and Reel	4-bump WL-CSP
AS1369-BWLT-18	ASP0	1.8V	200mA Ultra-Compact Low Dropout Regulator	Tape and Reel	4-bump WL-CSP
AS1369-BWLT-25	ASP1	2.5V	200mA Ultra-Compact Low Dropout Regulator	Tape and Reel	4-bump WL-CSP
AS1369-BWLT-28	ASP2	2.8V	200mA Ultra-Compact Low Dropout Regulator	Tape and Reel	4-bump WL-CSP
AS1369-BWLT-30	ASP3	3.0V	200mA Ultra-Compact Low Dropout Regulator	Tape and Reel	4-bump WL-CSP
AS1369-BWLT-33	ASP4	3.3V	200mA Ultra-Compact Low Dropout Regulator	Tape and Reel	4-bump WL-CSP
AS1369-BWLT-45*	ASP5	4.5V	200mA Ultra-Compact Low Dropout Regulator	Tape and Reel	4-bump WL-CSP
AS1369-BWLT-50*	ASP6	5.0V	200mA Ultra-Compact Low Dropout Regulator	Tape and Reel	4-bump WL-CSP

\*) Available upon request. Contact austriamicrosystems AG for details.

**Note:** All products are RoHS compliant and Pb-free.

Buy our products or get free samples online at ICdirect: <http://www.austriamicrosystems.com/ICdirect>

For further information and requests, please contact us <mailto:sales@austriamicrosystems.com>  
or find your local distributor at <http://www.austriamicrosystems.com/distributor>



## Copyrights

Copyright © 1997-2009, austriamicrosystems AG, Tobelbaderstrasse 30, 8141 Unterpremstaetten, Austria-Europe. Trademarks Registered ®. All rights reserved. The material herein may not be reproduced, adapted, merged, translated, stored, or used without the prior written consent of the copyright owner.

All products and companies mentioned are trademarks or registered trademarks of their respective companies.

## Disclaimer

Devices sold by austriamicrosystems AG are covered by the warranty and patent indemnification provisions appearing in its Term of Sale. austriamicrosystems AG makes no warranty, express, statutory, implied, or by description regarding the information set forth herein or regarding the freedom of the described devices from patent infringement. austriamicrosystems AG reserves the right to change specifications and prices at any time and without notice. Therefore, prior to designing this product into a system, it is necessary to check with austriamicrosystems AG for current information. This product is intended for use in normal commercial applications. Applications requiring extended temperature range, unusual environmental requirements, or high reliability applications, such as military, medical life-support or life-sustaining equipment are specifically not recommended without additional processing by austriamicrosystems AG for each application. For shipments of less than 100 parts the manufacturing flow might show deviations from the standard production flow, such as test flow or test location.

The information furnished here by austriamicrosystems AG is believed to be correct and accurate. However, austriamicrosystems AG shall not be liable to recipient or any third party for any damages, including but not limited to personal injury, property damage, loss of profits, loss of use, interruption of business or indirect, special, incidental or consequential damages, of any kind, in connection with or arising out of the furnishing, performance or use of the technical data herein. No obligation or liability to recipient or any third party shall arise or flow out of austriamicrosystems AG rendering of technical or other services.



## Contact Information

Headquarters

austriamicrosystems AG  
Tobelbaderstrasse 30  
A-8141 Unterpremstaetten, Austria

Tel: +43 (0) 3136 500 0  
Fax: +43 (0) 3136 525 01

For Sales Offices, Distributors and Representatives, please visit:

<http://www.austriamicrosystems.com/contact>