



Chipsmall Limited consists of a professional team with an average of over 10 year of expertise in the distribution of electronic components. Based in Hongkong, we have already established firm and mutual-benefit business relationships with customers from,Europe,America and south Asia,supplying obsolete and hard-to-find components to meet their specific needs.

With the principle of “Quality Parts,Customers Priority,Honest Operation,and Considerate Service”,our business mainly focus on the distribution of electronic components. Line cards we deal with include Microchip,ALPS,ROHM,Xilinx,Pulse,ON,Everlight and Freescale. Main products comprise IC,Modules,Potentiometer,IC Socket,Relay,Connector.Our parts cover such applications as commercial,industrial, and automotives areas.

We are looking forward to setting up business relationship with you and hope to provide you with the best service and solution. Let us make a better world for our industry!



Contact us

Tel: +86-755-8981 8866 Fax: +86-755-8427 6832

Email & Skype: info@chipsmall.com Web: www.chipsmall.com

Address: A1208, Overseas Decoration Building, #122 Zhenhua RD., Futian, Shenzhen, China



AS1390A, AS1390B

High Power Boost Controller and Buck Converter for LED Backlight

1 General Description

The AS1390A, AS1390B is a high-power, constant-frequency boost controller with an integrated buck converter. The AS1390A can be used for the boost converter in TV sets which are optimized for 2D and 3D mode. AS1390B is designed for single mode operation.

The continuous conduction mode of the AS1390 provides superior bandwidth and transient response. The two output voltages for the boost controller (2D and 3D mode) can be programmed with an external resistor divider.

The buck converter is optimized for supplying a μP with 5V.

The AS1390A is available in a 20-pin QFN (4x4mm) package, the AS1390B comes in a 16-pin SOIC package.

2 Key Features

- High Efficiency: Up to 95%
- Supply Voltage Range: 10V to 30V
- Boost Output Current: up to 3A
- Continuous Conduction Mode
- Undervoltage Lockout with hysteresis
- Overvoltage, Overcurrent and Overtemperature Protection
- Low Dropout Operation: 90% Duty Cycle
- Buck always ON, Boost with enable PIN
- Packages:
 - 20-pin QFN (4x4mm)
 - 16-pin SOIC

3 Applications

The device is ideal for LED backlighting for LCD - TV sets and monitors.

Figure 1. AS1390A - Typical Application

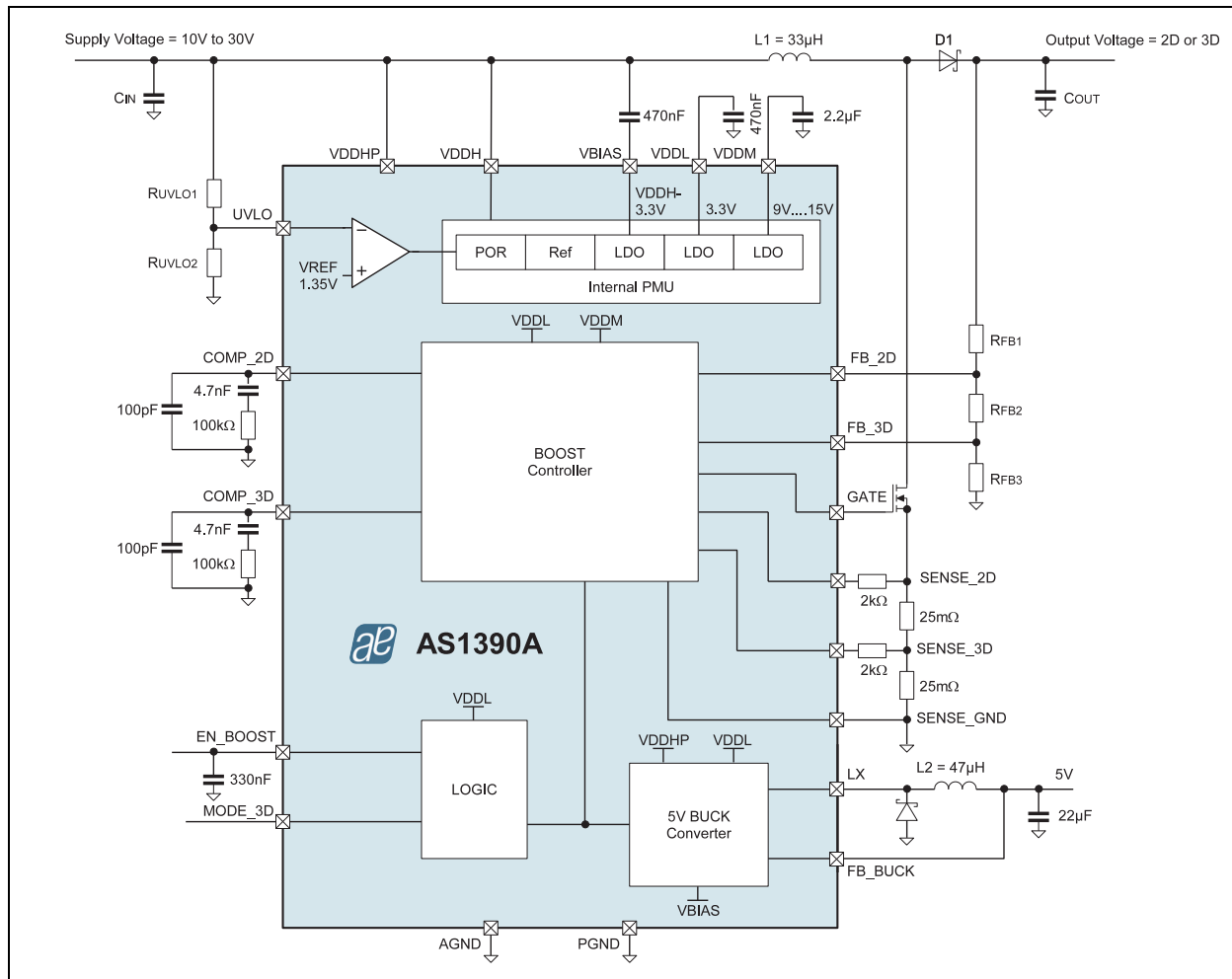
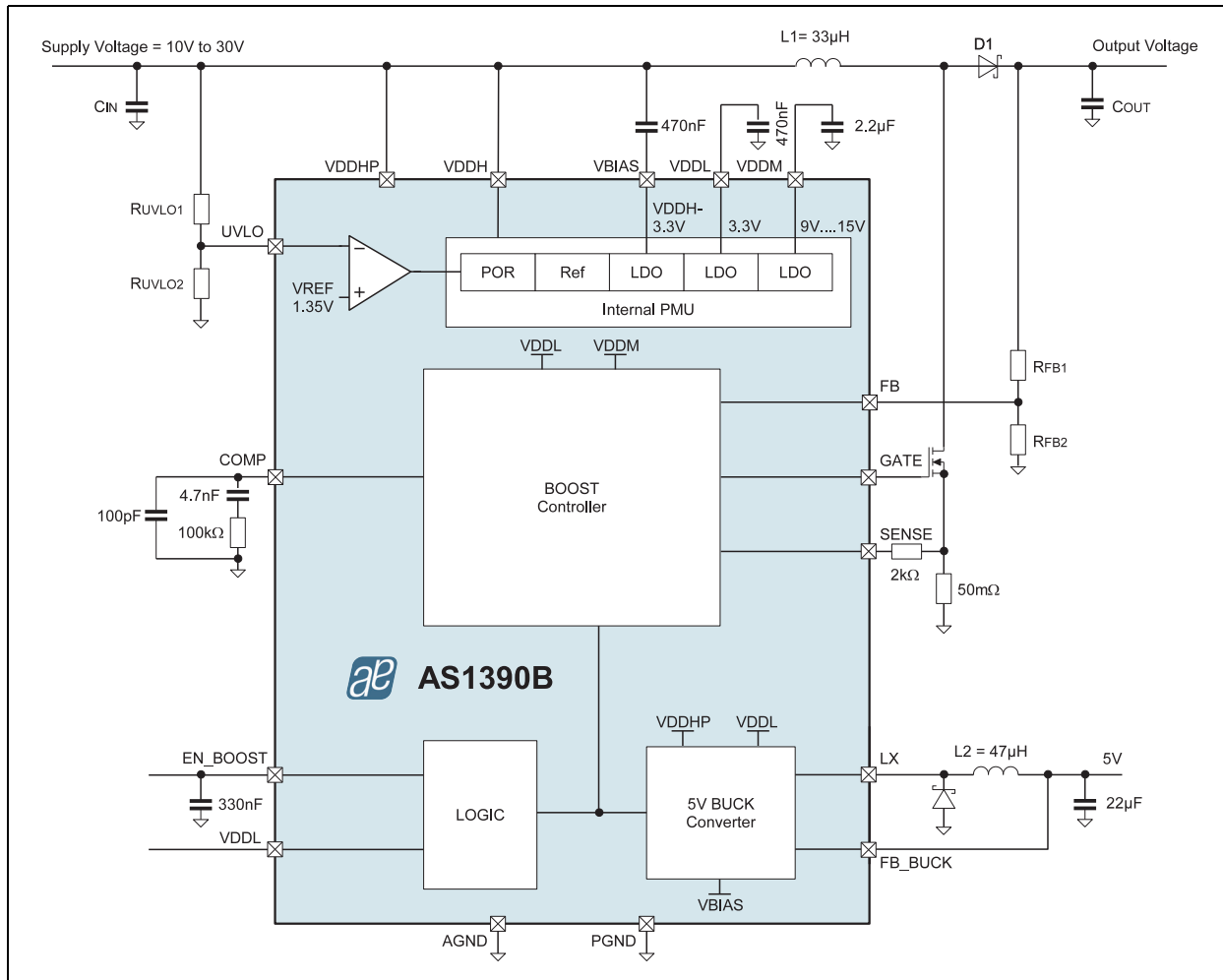




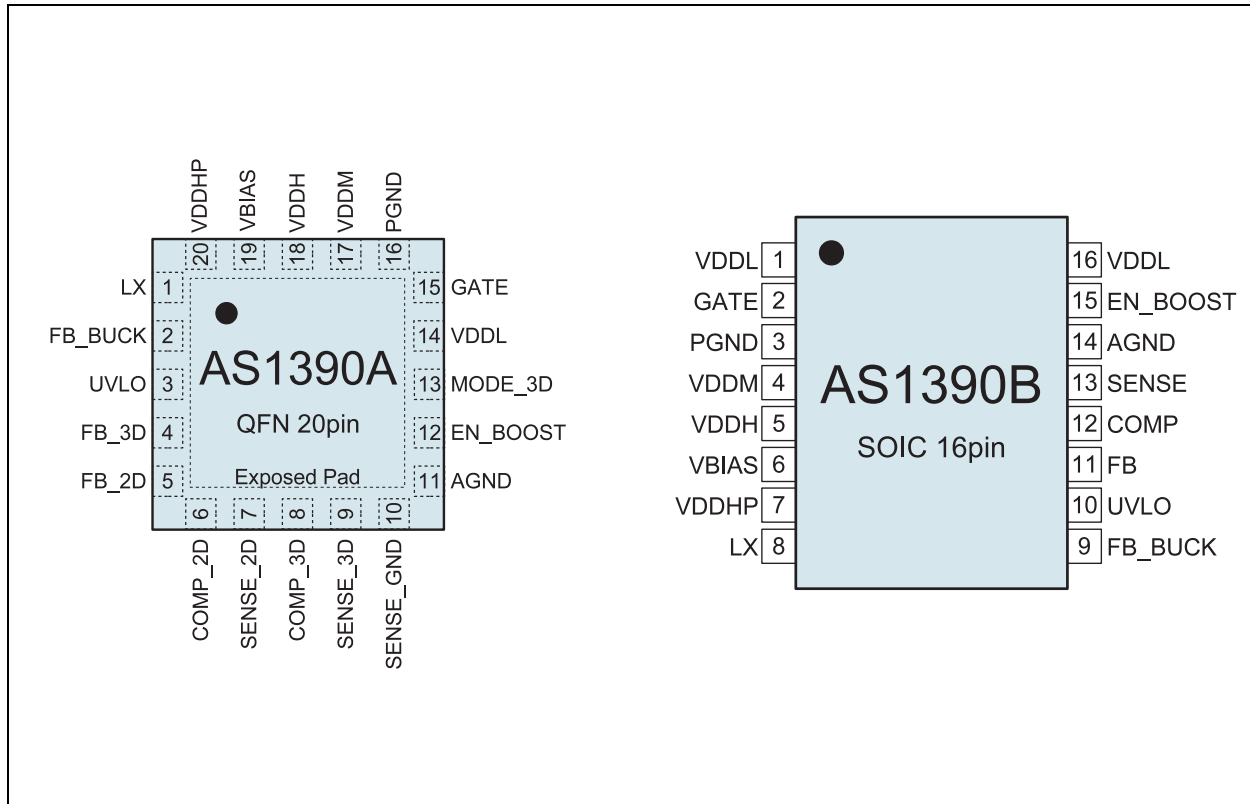
Figure 2. AS1390B - Typical Application





4 Pin Assignments

Figure 3. Pin Assignments (Top View)



4.1 Pin Descriptions

Table 1. Pin Descriptions

Pin Number		Pin Name	Pin Type	Description
AS1390A	AS1390B			
13	5	VDDH	P	Supply Voltage
3	10	UVLO	A I/O	Undervoltage Lockout
6	12	COMP_2D	A I/O	Compensation Network 2D. default
8		COMP_3D	A I/O	Compensation Network 3D
19	6	VBIAS	A I/O	High Side Regulator Output. Connect this pin to the Supply rail via a capacitor.
14	1, 16	VDDL	A I/O	Internal Regulator Output
17	4	VDDM	A I/O	Drive Voltage Regulator Output
5	11	FB_2D	A I/O	FB Input 2D. default
4		FB_3D	A I/O	FB Input 3D
15	2	GATE	A I/O	Gate Driver Output
7	13	SENSE_2D	A I/O	Current Sense Input 2D. default
9		SENSE_3D	A I/O	Current Sense Input 3D
10	-	SENSE_GND	A I/O	Current Sense Input GND. (only for AS1390A)



Table 1. Pin Descriptions

Pin Number		Pin Name	Pin Type	Description
AS1390A	AS1390B			
1	8	LX	A I/O	Inductor Connector. Connect an inductor from LX to the output of the buck converter
2	9	FB_BUCK	A I/O	Feedback Buck Pin. Connect this pin to the output of the buck converter
20	7	VDDHP	P	Supply for DCDC Buck-Converter
16	3	PGND	P	Power Ground
11	14	AGND	P	Analog Ground
12	15	EN_BOOST	D IN	Enable. Enables the Boost-Controller. 1 = Normal operation; 0 = Shutdown;
13	-	MODE_3D	D IN	Selection for 3D Mode. (only for AS1390A) 1 = 3D; 0 = 2D;
	-	Exposed Pad	n.c.	Exposed Pad. This pad is not connected internally. Can be left floating or connect to GND to achieve an optimal thermal performance.



5 Absolute Maximum Ratings

Stresses beyond those listed in [Table 2](#) may cause permanent damage to the device. These are stress ratings only, and functional operation of the device at these or any other conditions beyond those indicated in [Electrical Characteristics on page 6](#) is not implied. Exposure to absolute maximum rating conditions for extended periods may affect device reliability.

Table 2. Absolute Maximum Ratings

Parameter	Min	Max	Units	Notes
Electrical Parameters				
VDDH to AGND		40	V	
VDDL to AGND		5.0	V	
VDDM to AGND		20	V	
VBIAS to AGND	VDDH - 5.0	VDDH + 0.3	V	
PGND to AGND	-0.3	+0.3	V	
EN_BOOST, FB_2D, FB_3D, FB_BUCK	AGND - 0.3	VDD + 0.3	V	
Input Current (latch-up immunity)	-100	+100	mA	Norm: JEDEC 78 Ambient Temperature +85°C
	-50	+50	mA	Norm: JEDEC 78 Ambient Temperature 115°C
Electrostatic Discharge				
Human Body Model @ VDDH, VDDM, LX, VBIAS, GATE, VDDHP		4	kV	Norm: MIL 883 E method 3015
Human Body Model for all other pins		2	kV	
Temperature Ranges and Storage Conditions				
Junction Temperature (T _{J-MAX})		+115	°C	
Storage Temperature Range	-65	+150	°C	
Package Body Temperature		+260	°C	The reflow peak soldering temperature (body temperature) specified is in accordance with <i>IPC/JEDEC J-STD-020 "Moisture/Reflow Sensitivity Classification for Non-Hermetic Solid State Surface Mount Devices"</i> . The lead finish for Pb-free leaded packages is matte tin (100% Sn).
Humidity non-condensing	5	85	%	
Moisture Sensitive Level	3			Represents a maximum floor life time of 168h



6 Electrical Characteristics

All limits are guaranteed. The parameters with min and max values are guaranteed with production tests or SQC (Statistical Quality Control) methods.

$VDDH = 24V$, $EN_BOOST = 5V$, unless otherwise noted. Typical values are at $T_A = 25^\circ C$.

Table 3. Electrical Characteristics

Symbol	Parameter	Conditions	Min	Typ	Max	Units
T_A	Operating Temperature Range		-40		+85	$^\circ C$
T_J	Operating Junction Temperature Range		-40		+115	$^\circ C$
$VDDH$	Supply Voltage Range	Depending on external components an extended Supply Voltage Range up to 40V is possible	10		30	V
V_{FB}	Feedback Voltage			1.25		V
I_Q	Quiescent Supply Current			1		mA
Boost Converter						
$V_{OUT\ Boost}$	Output Voltage Range	Guaranteed by design and characterization. Depending on external components an extended Output Voltage Range up to 200V is possible	30		90	V
	Accuracy		-2		+2	%
$I_{OUT\ Boost}$	Output current Boost Converter			1000	3000	mA
f_{sw}	Boost Switching Frequency			275		kHz
Buck Converter						
$V_{OUT\ Buck}$	Output Voltage Range	$I_{OUT\ Buck} = 50mA$		5		V
	Accuracy		-5.0		+5.0	%
$I_{OUT\ Buck}$	Output current Buck Converter			100		mA
f_{sw}	Buck Switching Frequency			1000		kHz
R_{ON_Buck}	Driver ON Resistance Buck			3		Ω
Driver Stage						
R_{SWON1}	Driver ON Resistance Top			8		Ω
R_{SWON2}	Driver ON Resistance Bottom			8		Ω
$V_{DRV,peak}$	Driver Peak Voltage (voltage @ $VDDM$)			9		V
t_{RISE}	Driver Pin Rise Time	$C_Gs = 3nF$, $VDDM = 9V$, $V_{DRV} = 0$ to $3V$		25		ns
t_{FALL}	Driver Pin Fall Time			25		ns
Undervoltage Lockout						
V_{REF}	UVLO Reference Voltage			1.35		V
I_{HYST}	Hysteresis Current			20		μA
Enable						
$V_{IH,EN}$ $V_{IH,MODE}$	Logic high input threshold		1.8			V
$V_{IL,EN}$ $V_{IL,MODE}$	Logic low input threshold				0.8V	V
Thermal Protection						
	Thermal Shutdown Threshold			140		$^\circ C$
	Thermal Shutdown Hysteresis			30		$^\circ C$



7 Operating Characteristics

$V_{OUT\ Boost} = 60V$, $I_{OUT\ Boost} = 1A$, $V_{OUT\ Buck} = 5V$, $I_{OUT\ Buck} = 50mA$, $T_A = +25^\circ C$ (unless otherwise specified);

Figure 4. Boost - Efficiency vs. Output Current; $V_{IN} = 12V$

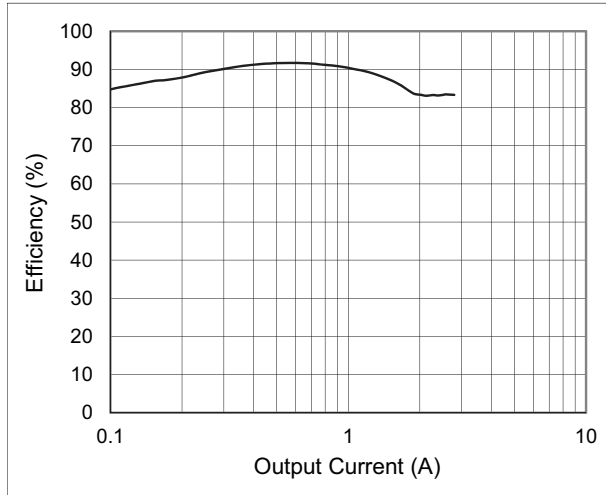


Figure 5. Boost - Output Voltage vs. Output Current; $V_{IN} = 12V$

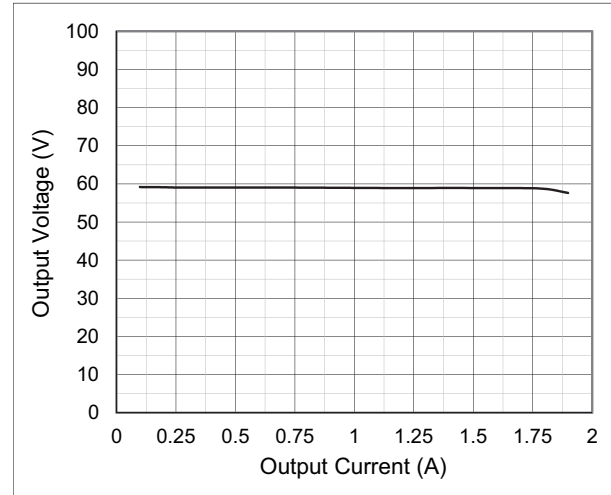


Figure 6. Boost - Efficiency vs. Output Current; $V_{IN} = 24V$

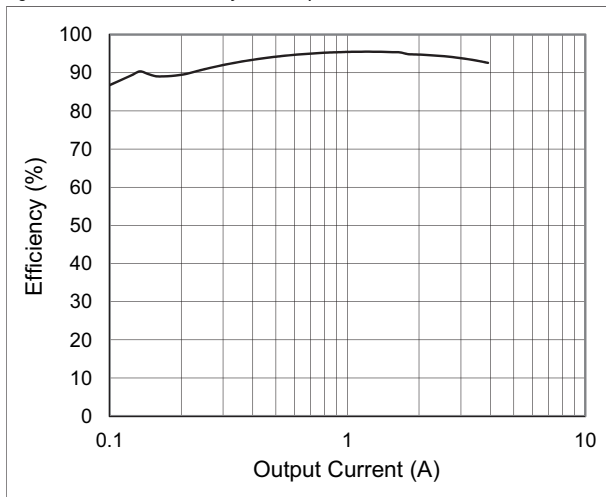


Figure 7. Boost - Efficiency vs. Input Voltage

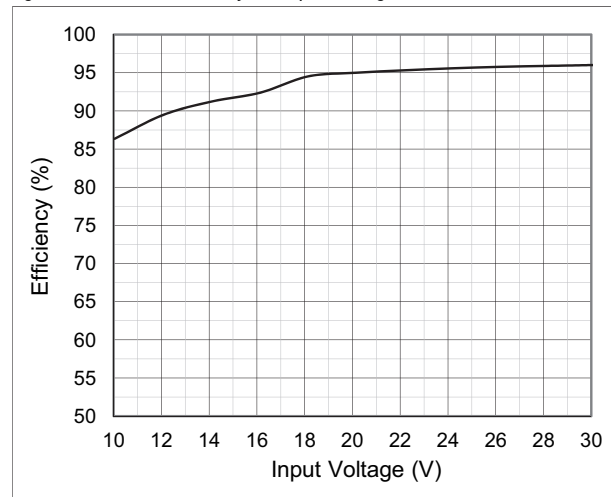


Figure 8. Boost - Output Voltage vs. Output Current; $V_{IN} = 24V$

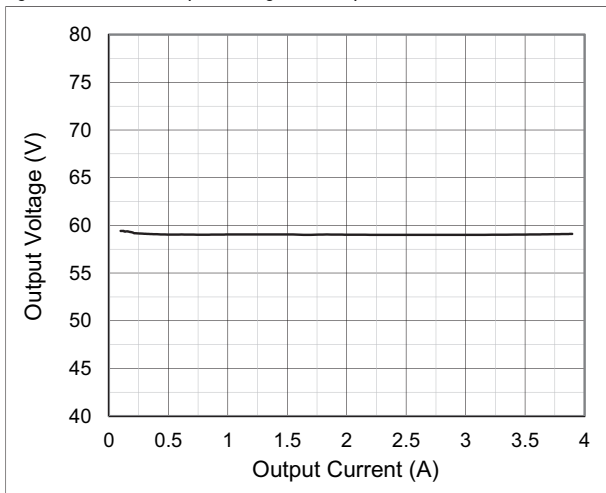


Figure 9. Boost - V_{OUT} vs. Temp.; $V_{IN} = 24V$, $I_{OUT} = 200mA$

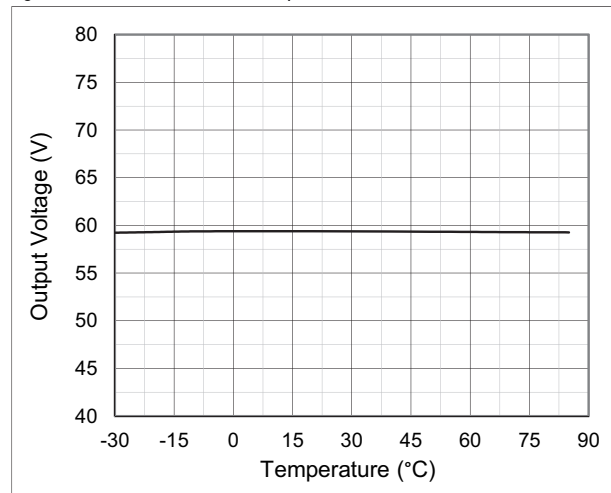




Figure 10. Buck - Efficiency vs. Output Current; $V_{IN} = 12V$

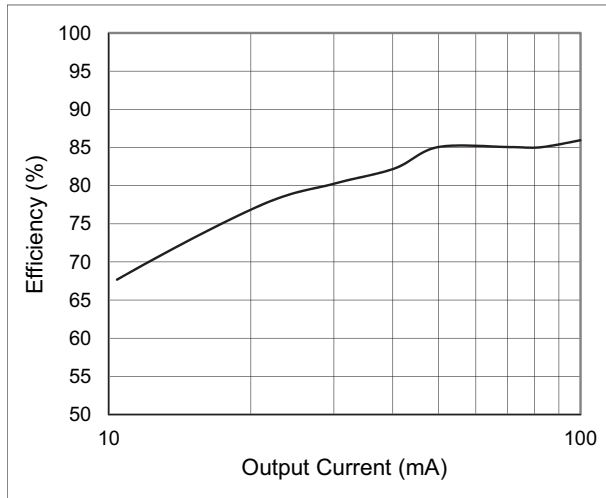


Figure 11. Buck - Output Voltage vs. Output Current; $V_{IN} = 12V$

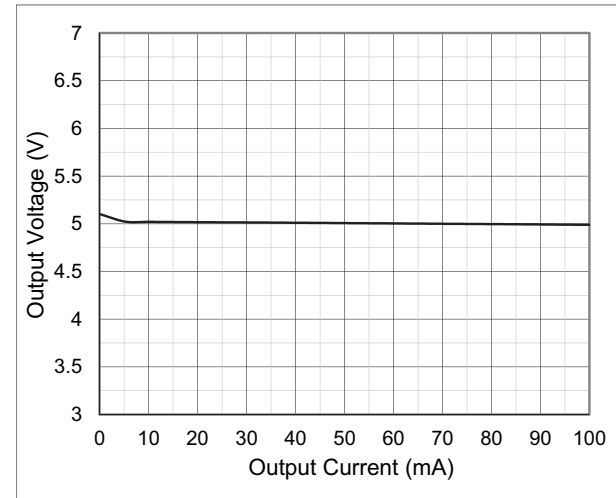


Figure 12. Buck - Efficiency vs. Output Current; $V_{IN} = 24V$

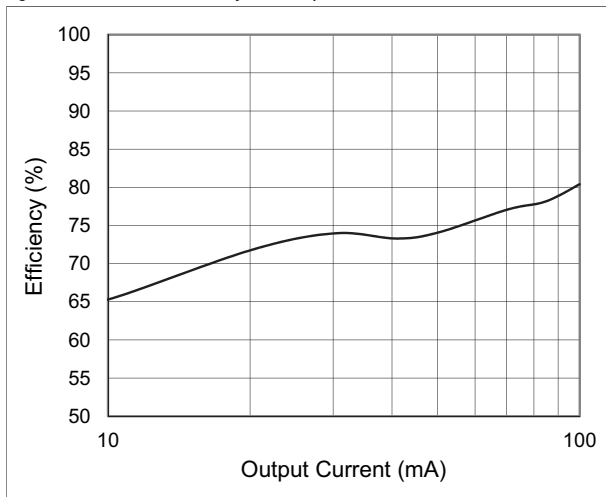


Figure 13. Buck - Output Voltage vs. Output Current; $V_{IN} = 24V$

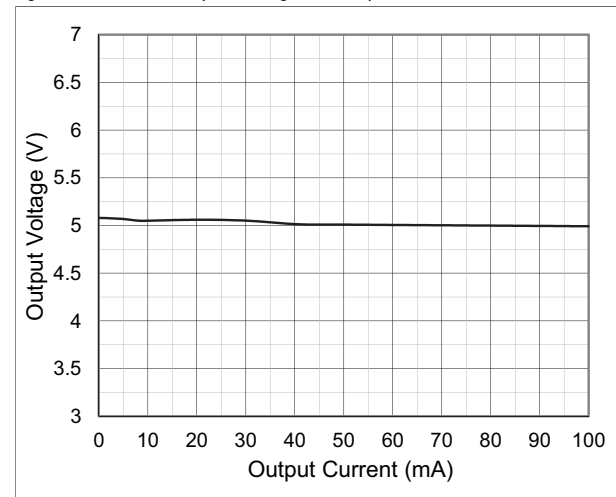


Figure 14. Buck - Efficiency vs. Input Voltage

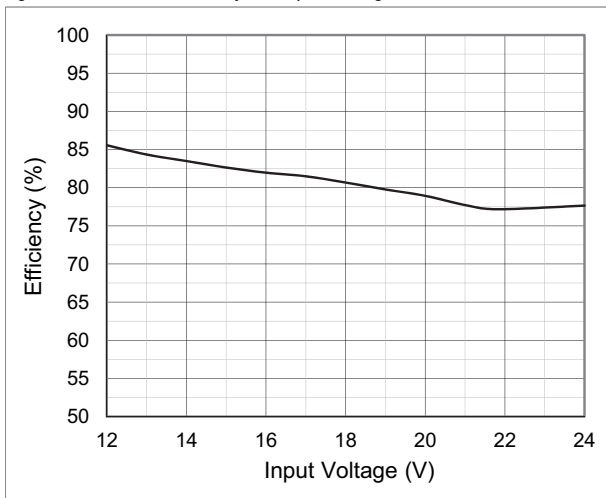


Figure 15. Buck - V_{OUT} vs. Temp.; $V_{IN} = 24V$

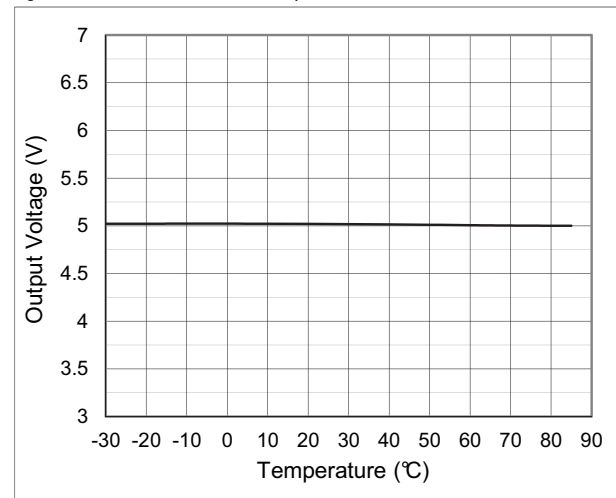




Figure 16. Load Regulation

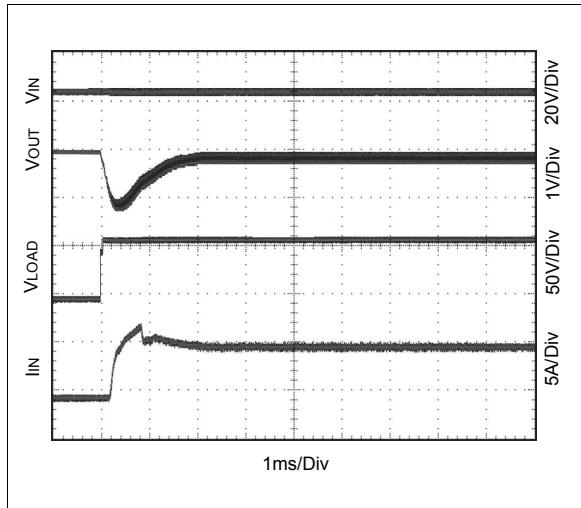
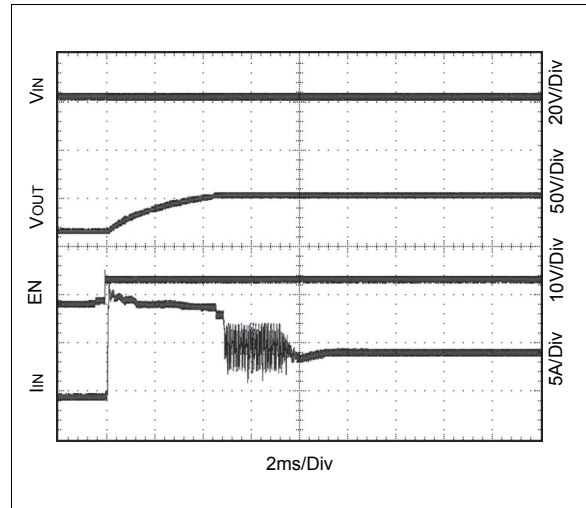


Figure 17. Start with EN_BOOST pin

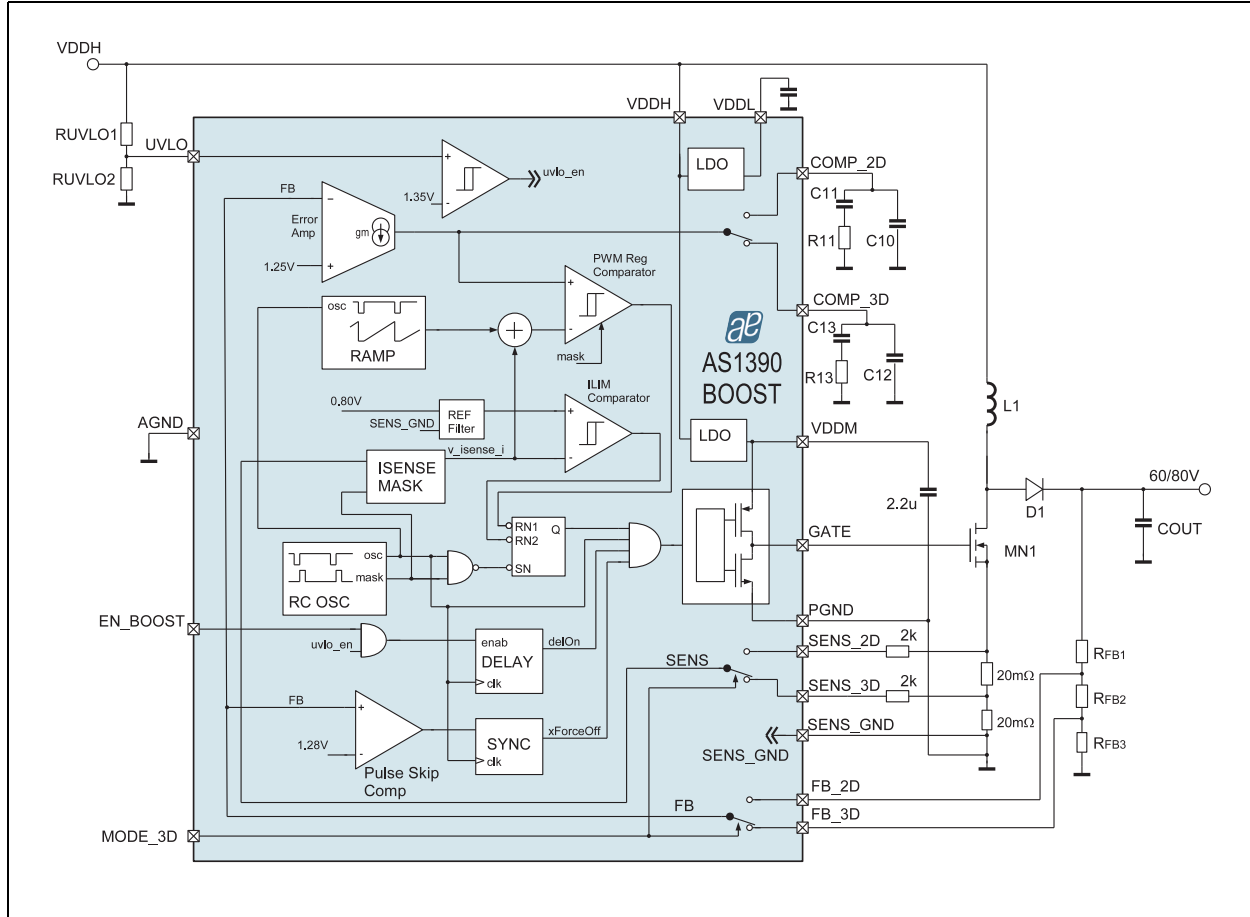




8 Detailed Description

The AS1390 is a high efficiency, high voltage and high current DC-DC Step-up controller combined with an Step-down converter. The device is designed for LED backlight in LCD TV-sets. The special feature is the optimized operation point for the 2D and 3D mode. Hence the output voltage of the Step-up Converter can easily be switched via the MODE_3D pin from one voltage to the other.

Figure 18. Detailed Block Diagram Boost Converter



8.1 Boost Controller

8.1.1 Setting Output Voltages

The Output voltages of the AS1390 are defined by a voltage divider between the FB pin and Vout. Due to the capability of the AS1390 to switch between two output voltages, two dividers are necessary to adjust both output voltages.

Output voltage for 2D-Mode:

$$V_{OUT-2D} = V_{FB} \times \left(1 + \frac{R_{FB1}}{R_{FB2} + R_{FB3}} \right) \quad (EQ 1)$$

Output voltage for 3D-Mode:

$$V_{OUT-3D} = V_{FB} \times \left(1 + \frac{R_{FB1} + R_{FB2}}{R_{FB3}} \right) \quad (EQ 2)$$

Where: $V_{FB} = 1.25V$

Note: The overall resistance should be in the range of 100k to 200kΩ to avoid any noise issues.



8.1.2 Undervoltage-Lockout (UVLO)

To enable the usage of the circuit with a wide input voltage range (typ. 12V and 24V), the threshold for undervoltage detection should be selectable by external components. Therefore a PAD UVLO is implemented, with an external resistor that selects the value of the threshold and implements also a hysteresis. Till UVLOCO gets deactivated, the threshold is higher, after UVLOCO is 0 (no undervoltage condition), the threshold is lowered by a switch-on of a constant current source.

If the undervoltage-lockout is not needed, connect the UVLO pin to VDDL.

Figure 19. UVLO - Comparator and External Resistor Divider

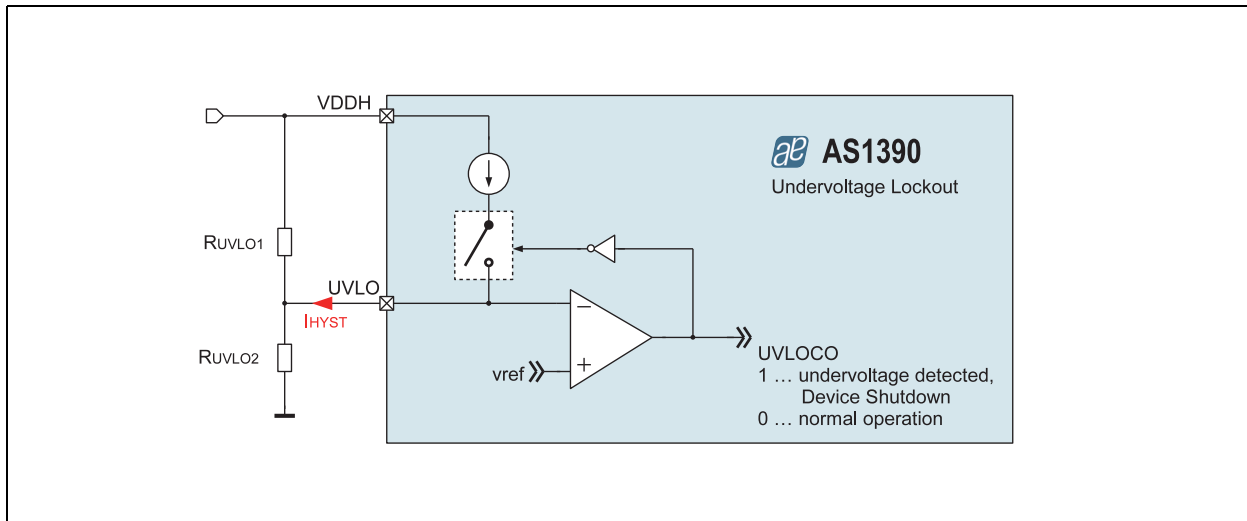
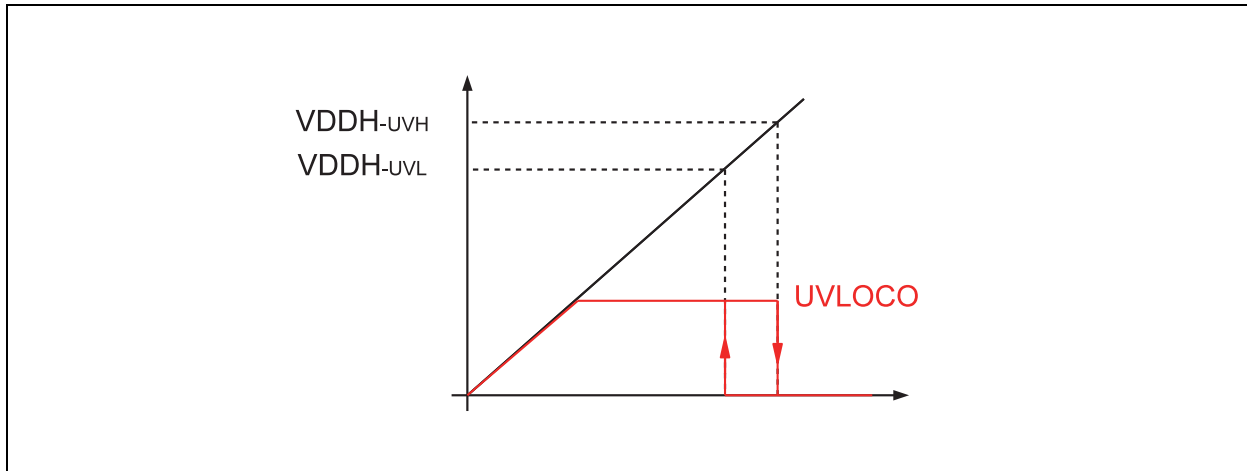


Figure 20. UVLO - Comparator Output



Following equations can be derived for adjusting the threshold voltages.

Undervoltage threshold High:

$$V_{DDH-UVH} = V_{REF} \times \left(1 + \frac{R_{UVLO1}}{R_{UVLO2}}\right) \quad (\text{EQ 3})$$

Undervoltage threshold Low:

$$V_{DDH-UVL} = V_{REF} \times \left(1 + \frac{R_{UVLO1}}{R_{UVLO2}}\right) - (I_{HYST} \times R_{UVLO1}) \quad (\text{EQ 4})$$

Where: $I_{HYST} = 20\mu\text{A}$

$V_{REF} = 1.35\text{V}$



8.1.3 Continuous Conduction Mode (CCM)

For normal operation the converter should stay in continuous conduction mode, to ensure that the inductor value must be bigger than L_{CRIT}.

$$L_{CRIT} = \frac{\left(1 - \frac{V_{IN}}{V_{OUT} + V_D}\right) \times V_{IN}^2 \times R}{2 \times f_{SW} \times (V_{OUT} + V_D)^2} \quad (\text{EQ 5})$$

Where:

V_{IN} ... Input voltage at VDDH

V_{OUT} ... Output voltage

V_D ... Diode forward voltage at D1

f_{sw} ... Switching frequency

R ... Load resistor, should be calculated with minimum current load $R = V_{OUT} / I_{OUT_min}$

I_{OUT_min} ... Minimum output current (e.g. for LED driver only one LED string is on)

8.1.4 Duty Cycle

Within CCM, the well known relation between input and output voltage is described in the following equation:

$$\frac{V_{OUT} + V_D}{V_{IN}} = \frac{1}{1 - D} \quad (\text{EQ 6})$$

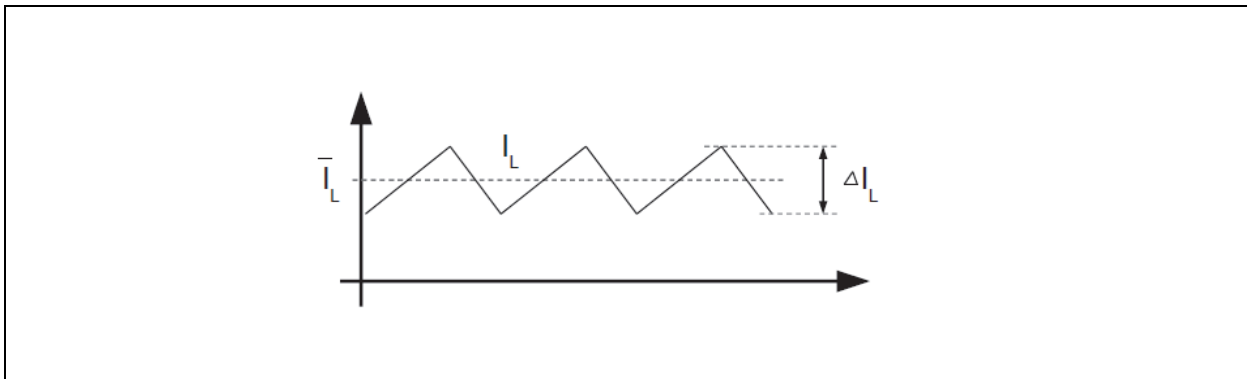
This means for the duty cycle:

$$D = 1 - \frac{V_{IN}}{V_{OUT} + V_D} \quad (\text{EQ 7})$$

8.1.5 Inductor Current

The inductor current varies during a switching cycle. This variation can be expressed by the mean value of the inductor current and the delta rise/fall current within each cycle (see Figure 21).

Figure 21. Inductor Current



Mean inductor current:

$$\bar{I}_L = \frac{I_{OUT}}{1 - D} \quad (\text{EQ 8})$$

Delta inductor current:

$$\Delta I_L = \frac{D \times V_{IN}}{f_S \times L} \quad (\text{EQ 9})$$



Peak current:

$$I_{pk} = \bar{I}_L + \frac{\Delta I_L}{2} = \frac{I_{OUT}}{1-D} + \frac{D \times V_{IN}}{2 \times f_S \times L} \quad (\text{EQ 10})$$

RMS inductor current:

$$I_{RMS} = \sqrt{\bar{I}_L^2 + (1/12 \times \Delta I_L)^2} \quad (\text{EQ 11})$$

This peak current is flowing through MN1 during phase 1 and through D1 during phase 2 of each cycle. Therefore this peak current is important for a proper diode D1, MOSFET MN1 and inductor L1 selection.

Note: The saturation current of the inductor should be about 20 to 30% larger than the peak current.

8.1.6 Input Capacitor

The input capacitor has to supply the delta inductor current and it should be selected according to:

$$C_{IN} > \frac{\Delta I_L}{4 \times \Delta V_{IN} \times f_{SW}} \quad (\text{EQ 12})$$

$$ESR < \frac{\Delta V_{IN}}{2 \times \Delta I_L} \quad (\text{EQ 13})$$

8.1.7 Output Capacitor

The output capacitor must be chosen according to the maximum allowable output ripple at high load.

$$C_{OUT} > \frac{I_{OUT-max} \times D}{\Delta V_{OUT} \times f_{SW}} \quad (\text{EQ 14})$$

$$ESR < \frac{\Delta V_{OUT}}{\left(\frac{I_{OUT}}{1-D} + \frac{V_{IN} \times D}{2 \times L \times f_{SW}} \right)} \quad (\text{EQ 15})$$

8.1.8 Current Sense Resistor

$$R_{S-max} = \frac{V_{SENSE}}{\bar{I}_L + 0,5 \times \Delta I_L} \quad (\text{EQ 16})$$

$$P_{RS} = I_{L-rms}^2 \times R_S \times D \quad (\text{EQ 17})$$

Note: Low inductance and specifically designed current sensing resistors should be used, e.g. Stackpole Electronics CSR/CSRN series of sensing resistors with less than 0.2nH (typ).

8.1.9 Compensation Network

For typical use cases a compensation network should be implemented by C10, C11 and R11 for 2D mode and optional by different component values C12, C13, R13 for 3D mode (see Figure 18 on page 10).

A typical choice for values of the compensation network is C10 = 100pF, C11 = 10nF, R11 = 100KΩ. Use these values as initial choice and evaluate the transient response of the system to verify the behavior at output load change. To be able to do a different compensation for 3D mode, a second pin COMP_3D is available. If no separate compensation for 3D mode is necessary, PINs COMP_2D and COMP_3D can be connected to one common compensation network.

8.2 Buck Converter

The buck converter of the AS1390 is working with high-efficiency at a constant-frequency. The buck converter is optimized to supply a μC and with a fixed output voltage of 5V.

The buck converter is working as soon as the AS1390 is powered-up but offers an automatic power save mode. The highly efficient duty cycle provides low dropout operation, which reduces the power consumption of the system.



8.3 Overvoltage Protection (OVP)

An overvoltage condition is detected when the feedback voltage is higher than the skip threshold (1.28V typ). The device is then entering the skip mode. Meaning the next pulse will be skipped and in the next cycle the overvoltage check is done again.

8.4 Overcurrent Protection (OCP)

An overcurrent comparator is monitoring the output current via the sense pin. If an overcurrent condition occurs the transistor will be switched off immediately. After the overcurrent condition is removed the device is returning to normal operation again.

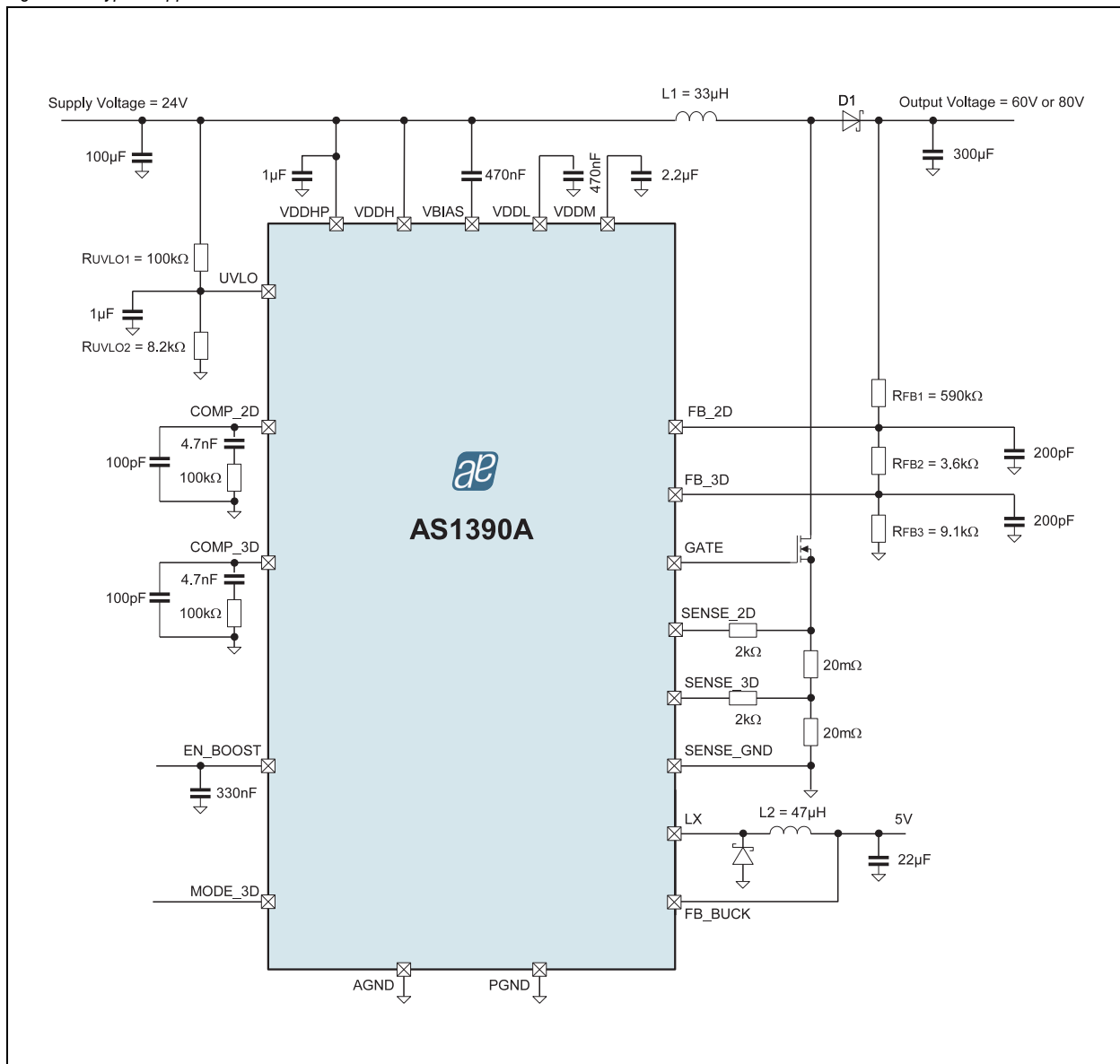
8.5 Overtemperature Protection (OTP)

As soon as the junction temperature reaches approximately 140°C the AS1390 goes in thermal shutdown. In this mode the internal transistors are turned off. The device will power up again, as soon as the temperature falls below +110°C again.



9 Application Information

Figure 22. Typical Application



9.1 Recommended External Components

In order to reach the highest efficiency and best performance of the device we recommend to use the following external components.

For the capacitors and resistors standard available components can be used. Depending on the desired voltage and the current special inductors and transistors should be used to guarantee best performance for high current and high voltage operation. For the transistor we recommend the SIR432DP from Vishay Siliconix for the Inductors (see Table 4).

Table 4. Recommended Inductors

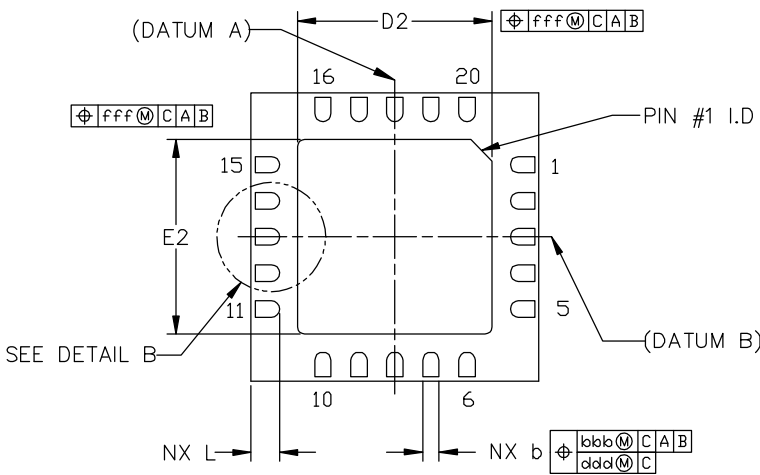
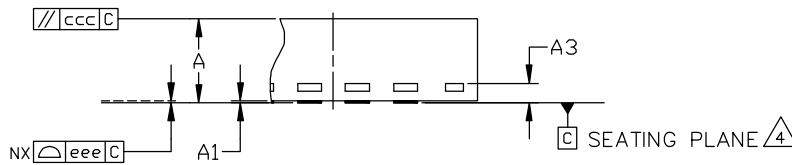
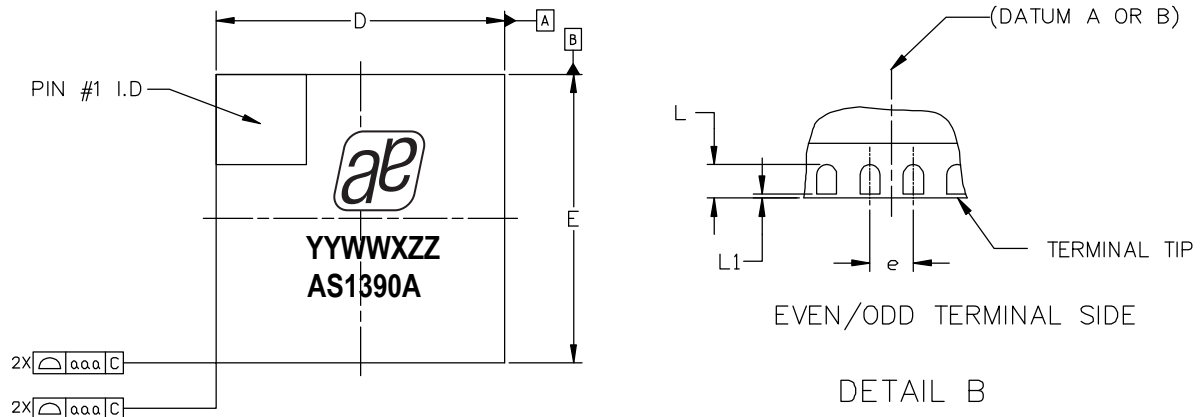
Part Number	L	DCR	Current Rating	Dimensions (L/W/T)	Manufacturer
74435573300	33µH	22mΩ	8.5A	18.3x18.2x8.9mm	Würth Elektronik www.we-online.de
VLCF4020T-470MR39	47µH	849mΩ	0.39A	4.0x4.0x2.0mm	TDK www.tdk.com



10 Package Drawings and Markings

The product is available in a 20-pin QFN (4x4mm) and 16-pin SOIC package.

Figure 23. 20-pin QFN (4x4mm) Package



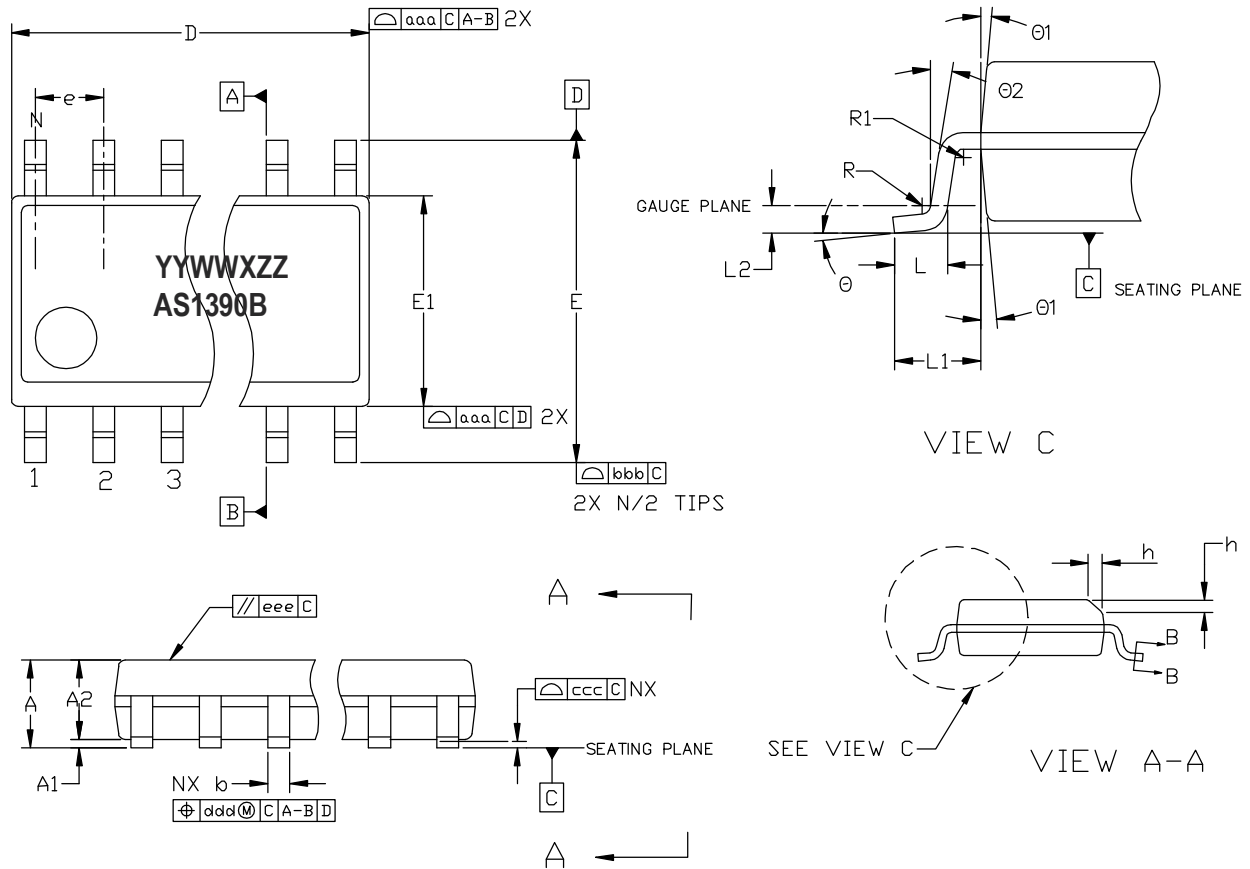
Symbol	Min	Nom	Max
A	0.80	0.90	1.00
A1	0	0.02	0.05
A3	-	0.20 REF	-
L	0.35	0.40	0.45
L1	0	-	0.15
b	0.18	0.25	0.30
D	4.00 BSC		
E	4.00 BSC		
e	0.50 BSC		
D2	2.60	2.70	2.80
E2	2.60	2.70	2.80
aaa	-	0.15	-
bbb	-	0.10	-
ccc	-	0.10	-
ddd	-	0.05	-
eee	-	0.08	-
fff	-	0.10	-
N	20		

Notes:

1. Dimensioning & tolerancing conform to ASME Y14.5M-1994.
2. All dimensions are in millimeters. Angles are in degrees.
3. Dimension b applies to metallized terminal and is measured between 0.25mm and 0.30mm from terminal tip. Dimension L1 represents terminal full back from package edge up to 0.15mm is acceptable.
4. Coplanarity applies to the exposed heat slug as well as the terminal.
5. Radius on terminal is optional.
6. N is the total number of terminals.

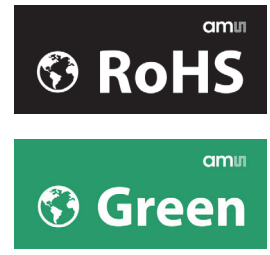
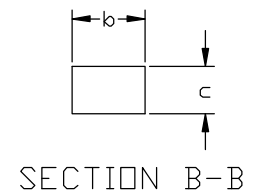


Figure 24. 16-pin SOIC Package



Symbol	Min	Nom	Max
A	-	-	1.75
A1	0.10	-	0.25
A2	1.25	-	-
b	0.31	-	0.51
c	0.17	-	0.25
D	-	9.90 BSC	-
E	-	6.00 BSC	-
E1	-	3.90 BSC	-
e	-	1.27 BSC	-
L	0.40	-	1.27
L1	-	1.40 REF	-
L2	-	0.25 BSC	-
R	0.07		
R1	0.07		

Symbol	Min	Nom	Max
h	0.25	-	0.50
Θ	0°	-	8°
$\Theta 1$	5°	-	15°
$\Theta 2$	0°	-	-
aaa	-	0.10	-
bbb	-	0.20	-
ccc	-	0.10	-
ddd	-	0.25	-
eee	-	0.10	-
fff	-	0.15	-
ggg	-	0.15	-
N	-	16	-



Notes:

1. Dimensioning & tolerancing conform to ASME Y14.5M-1994.
2. All dimensions are in millimeters. Angles are in degrees.

Marking: YYWWXZZ.

YY	WW	X	ZZ
Last two digits of the current year	Manufacturing week	Plant identifier	Free choice / traceability code



Revision History

Revision	Date	Owner	Description
1.0 - 1.4		afe	Initial releases
1.5	04 Jul, 2012		Added "Latch-up temperature limits" and 115°C die operating temperature
1.6	30 Aug, 2012		Minor update in the ordering section
1.7	07 Nov, 2012		Operating Junction Temperature Range Max value updated (see Table 3). Company logo updated.

Note: Typos may not be explicitly mentioned under revision history.



11 Ordering Information

The device is available as the standard products listed below.

Table 5. Ordering Information

Ordering Code	Marking	Description	Delivery Form	Package
AS1390A-BQFT	AS1390A	High Power Boost Controller and Buck Converter for LED Backlight	Tape and Reel	20-pin QFN (4x4mm)
AS1390B-BSOT	AS1390B		Tape and Reel	16-pin SOIC

Note: All products are RoHS compliant and ams green.
Buy our products or get free samples online at www.ams.com/ICdirect

Technical Support is available at www.ams.com/Technical-Support

For further information and requests, email us at sales@ams.com
(or) find your local distributor at www.ams.com/distributor



Copyrights

Copyright © 1997-2012, ams AG, Tobelbaderstrasse 30, 8141 Unterpemstaetten, Austria-Europe. Trademarks Registered ®. All rights reserved. The material herein may not be reproduced, adapted, merged, translated, stored, or used without the prior written consent of the copyright owner.

All products and companies mentioned are trademarks or registered trademarks of their respective companies.

Disclaimer

Devices sold by ams AG are covered by the warranty and patent indemnification provisions appearing in its Term of Sale. ams AG makes no warranty, express, statutory, implied, or by description regarding the information set forth herein or regarding the freedom of the described devices from patent infringement. ams AG reserves the right to change specifications and prices at any time and without notice. Therefore, prior to designing this product into a system, it is necessary to check with ams AG for current information. This product is intended for use in normal commercial applications. Applications requiring extended temperature range, unusual environmental requirements, or high reliability applications, such as military, medical life-support or life-sustaining equipment are specifically not recommended without additional processing by ams AG for each application. For shipments of less than 100 parts the manufacturing flow might show deviations from the standard production flow, such as test flow or test location.

The information furnished here by ams AG is believed to be correct and accurate. However, ams AG shall not be liable to recipient or any third party for any damages, including but not limited to personal injury, property damage, loss of profits, loss of use, interruption of business or indirect, special, incidental or consequential damages, of any kind, in connection with or arising out of the furnishing, performance or use of the technical data herein. No obligation or liability to recipient or any third party shall arise or flow out of ams AG rendering of technical or other services.



Contact Information

Headquarters

ams AG
Tobelbaderstrasse 30
A-8141 Unterpemstaetten, Austria

Tel : +43 (0) 3136 500 0
Fax : +43 (0) 3136 525 01

For Sales Offices, Distributors and Representatives, please visit:

<http://www.ams.com/contact>