



Chipsmall Limited consists of a professional team with an average of over 10 year of expertise in the distribution of electronic components. Based in Hongkong, we have already established firm and mutual-benefit business relationships with customers from,Europe,America and south Asia,supplying obsolete and hard-to-find components to meet their specific needs.

With the principle of “Quality Parts,Customers Priority,Honest Operation,and Considerate Service”,our business mainly focus on the distribution of electronic components. Line cards we deal with include Microchip,ALPS,ROHM,Xilinx,Pulse,ON,Everlight and Freescale. Main products comprise IC,Modules,Potentiometer,IC Socket,Relay,Connector.Our parts cover such applications as commercial,industrial, and automotives areas.

We are looking forward to setting up business relationship with you and hope to provide you with the best service and solution. Let us make a better world for our industry!



Contact us

Tel: +86-755-8981 8866 Fax: +86-755-8427 6832

Email & Skype: info@chipsmall.com Web: www.chipsmall.com

Address: A1208, Overseas Decoration Building, #122 Zhenhua RD., Futian, Shenzhen, China



AS13986

Dual Low-Noise, Low-Dropout Voltage Regulator

1 General Description

The AS13986 dual low-dropout regulator provides up to 150mA at each output using a 2.5 to 5.5V input voltage. The ultra-low drop-out voltage, low quiescent current, and low noise make the AS13986 perfect for low-power, battery-operated applications.

Regulator ground current increases only slightly in drop-out, extending the battery life in low-power applications.

The device features excellent power supply rejection (55dB @ 1kHz and 50dB at 10kHz). The high power supply rejection is maintained down to low input voltage levels used in battery operated devices.

Integrated shutdown logic control function is available for each output. In cases where the device is used as a local regulator it is possible to switch some of the circuitry into standby mode, thus decreasing total power consumption.

The AS13986 was specifically designed to work with low-ESR ceramic capacitors.

The AS13986 is available in a 8-pin WLP package.

2 Key Features

- Input Voltage: 2.5 to 5.5V
- Dual Output Voltages: 1.2 to 5.0V (in 50mV Steps)
- Ultra-Low Dropout Voltage: 45mV @ 150mA Load, 0.3mV @ 1mA Load
- Very Low Quiescent Current: 135µA @ No Load, 255µA @ 150mA Load, 2µA In Off Mode
- Guaranteed Output Current up to 150mA
- Fast Turn-On Time: 160µs (C_{OUT} = 1µF, C_{BYPASS} = 10nF, I_{OUT} = 1mA)
- Logic-Controlled Shutdown
- Up to 1.5% Output Voltage Accuracy
- Integrated Current-Limit and Thermal Overload Protection
- Output Low-Noise Voltage: 30µVRMS (10Hz to 100kHz)
- Supply Voltage Rejection: 55dB @ 1kHz, 50dB @ 10kHz
- Stable With Low-ESR Ceramic Capacitors
- Temperature Range: -40 to 125°C
- 8-pin WLP Package

3 Applications

The device is ideal for powering cordless and mobile phones, MP3 players, CD and DVD players, PDAs, handheld computers, digital cameras and any other hand-held battery-powered device.

Figure 1. AS13986 - Block Diagram

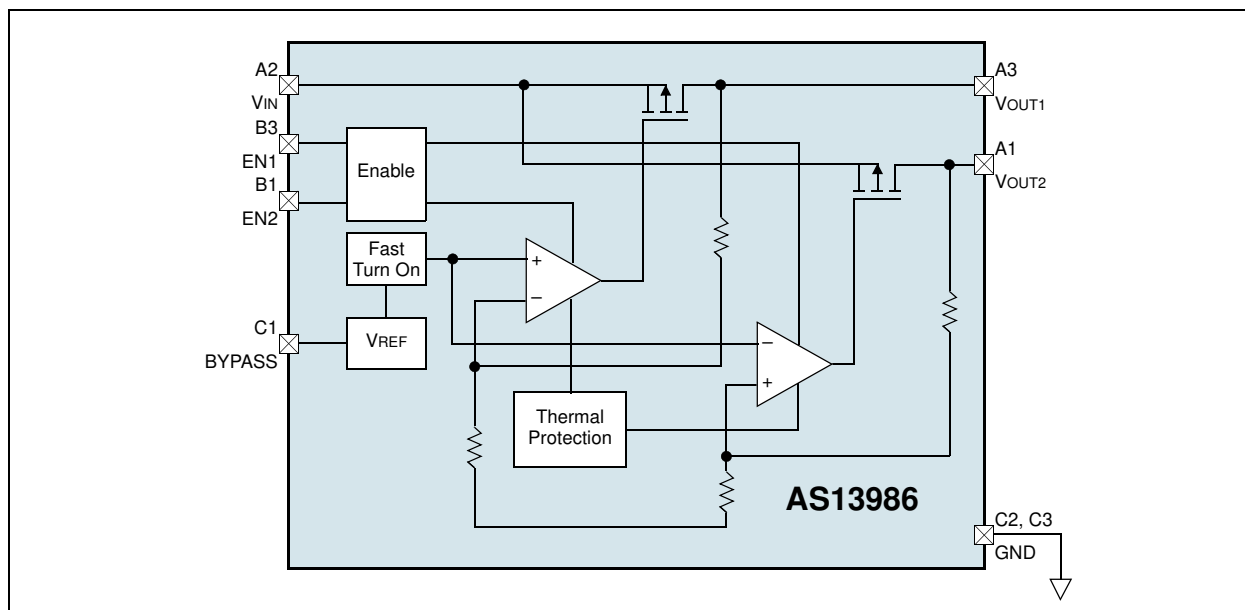

4 Pinout

Pin Assignments

Figure 2. Pin Assignments (Top View)

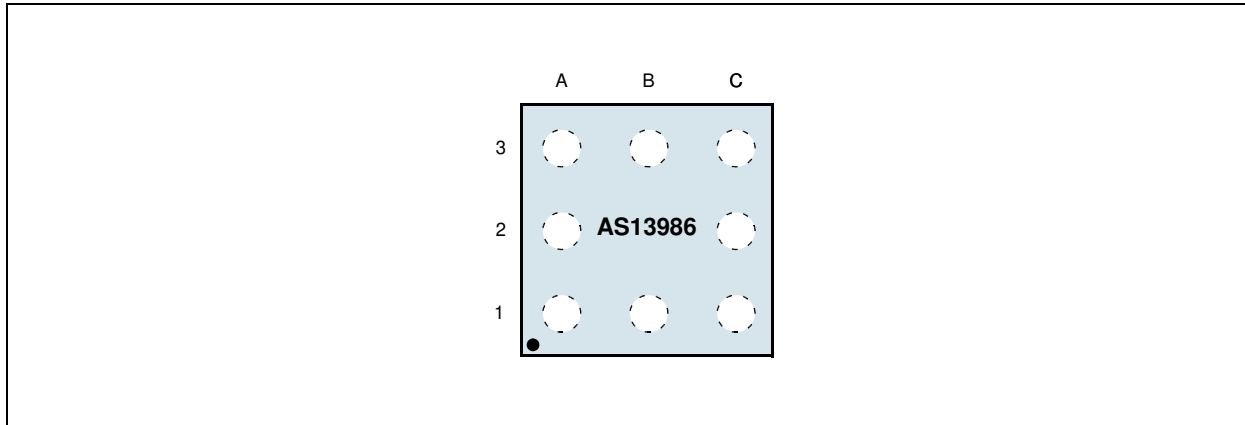

Pin Descriptions

Table 1. Pin Descriptions

Pin Number	Pin Name	Description
A1	VOUT2	Regulated Output Voltage 2
B1	EN2	Output Voltage 2 Enable/Disable $V_{EN} \leq 0.4V$: VOUT2 is disabled. $V_{EN} \geq 1.2V$: VOUT2 is enabled. Note: This pin must not float as it is not internally pulled-up or pulled-down.
C1	BYPASS	Bypass Pin. This pin should be connected to an external capacitor (10nF typ) to minimize noise.
C2	GND	Common Ground
C3	GND	Common Ground
B3	EN1	Output Voltage 1 Enable/Disable $V_{EN} \leq 0.4V$: VOUT1 is disabled. $V_{EN} \geq 1.2V$: VOUT1 is enabled.
A3	VOUT1	Regulated Output Voltage 1
A2	VIN	Input Voltage

5 Absolute Maximum Ratings

Stresses beyond those listed in [Table 2](#) may cause permanent damage to the device. These are stress ratings only, and functional operation of the device at these or any other conditions beyond those indicated in [Electrical Characteristics on page 4](#) is not implied. Exposure to absolute maximum rating conditions for extended periods may affect device reliability.

Table 2. Absolute Maximum Ratings

Parameter	Min	Max	Units	Comments
DC Input Voltage	-0.3	7	V	
DC Output Voltage	-0.3	$V_{IN} + 0.3$	V	
ENABLE Input Voltage	-0.3	$V_{IN} + 0.3$	V	
Output Current	Internally limited			
Power Dissipation	Internally limited			
Storage Temperature Range	-65	+150	°C	
Operating Junction Temperature Range	-40	+125	°C	
Thermal Resistance Junction Ambient Temperature		+120	°C/W	
Package Body Temperature		+260	°C	The reflow peak soldering temperature (body temperature) specified is in accordance with <i>IPC/JEDEC J-STD-020C "Moisture/Reflow Sensitivity Classification for Non-Hermetic Solid State Surface Mount Devices"</i> . The lead finish for Pb-free leaded packages is matte tin (100% Sn).

6 Electrical Characteristics

$T_{AMB} = 25^{\circ}\text{C}$, $V_{IN} = V_{OUT(NOM)} + 0.5\text{V}$, $C_{OUT} = C_{IN} = 1\mu\text{F}$, $C_{BYPASS} = 10\text{nF}$, $I_{OUT} = 1\text{mA}$, $V_{EN} = 1.2\text{V}$ (unless otherwise specified)

Note: Exposing the WLP package to direct light could cause device malfunction.

Table 3. Electrical Characteristics

Symbol	Parameter	Conditions	Min	Typ	Max	Unit	
V_{IN}	Operating Input Voltage		2.5		5.5	V	
ΔV_{OUT}	Output Voltage Tolerance $V_{OUT} \geq 3\text{V}$	$I_{OUT} = 1\text{mA}$	-1.5		1.5	% of $V_{OUT(NOM)}$	
		$T_{AMB} = -40$ to 125°C	-2.5		2.5		
	Output Voltage Tolerance $V_{OUT} < 3\text{V}$	$I_{OUT} = 1\text{mA}$	-75		75	mV	
		$T_{AMB} = -40$ to 125°C	-100		100		
	Line Regulation ¹		$V_{IN} = (V_{OUT(NOM)} + 0.5\text{V})$ to 4.5V , $V_{OUT} < 3\text{V}$	-0.2		0.2	%/ V
			$V_{IN} = (V_{OUT(NOM)} + 0.5\text{V})$ to 5.5V , $V_{OUT} < 3\text{V}$	-0.35		0.35	
Load Regulation ¹		$I_{OUT} = 1$ to 150mA		0.003	0.008	%/ mA	
Output AC Line Regulation (Figure 3)		$V_{IN} = V_{OUT(NOM)} + 1\text{V}$, $I_{OUT} = 150\text{mA}$, $t_R = t_F = 30\mu\text{s}$		1		mVpp	
IQ	Quiescent Current	Both Outputs Enabled, $V_{EN} = 1.4\text{V}$, $I_{OUT} = 0\text{mA}$		135		μA	
		Both Outputs Enabled, $V_{EN} = 1.4\text{V}$, $I_{OUT} = 0\text{mA}$, $T_{AMB} = -40$ to 125°C			200		
		Both Outputs Enabled, $V_{EN} = 1.4\text{V}$, $I_{OUT} = 0$ to 150mA		255			
		Both Outputs Enabled, $V_{EN} = 1.4\text{V}$, $I_{OUT} = 0\text{mA}$ to 150mA , $T_{AMB} = -40$ to 125°C			370 ²		
		Both Outputs Disabled, $V_{EN} = 0.4\text{V}$		0.001 ²			
		Both Outputs Disabled, $V_{EN} = 0.4\text{V}$, $T_{AMB} = -40$ to 125°C			4		
		One Output Enabled, $I_{OUT} = 0\text{mA}$		90			
		One Output Enabled, $V_{EN} = 1.4\text{V}$, $I_{OUT} = 0\text{mA}$, $T_{AMB} = -40$ to 125°C			130		
		One Output Enabled, $V_{EN} = 1.4\text{V}$, $I_{OUT} = 0$ to 150mA		100			
		One Output Enabled, $V_{EN} = 1.4\text{V}$, $I_{OUT} = 0$ to 150mA , $T_{AMB} = -40$ to 125°C			220 ²		
V_{LOAD}	Dropout Voltage ³	$I_{OUT} = 1\text{mA}$		0.3		mV	
		$I_{OUT} = 1\text{mA}$, $T_{AMB} = -40$ to 125°C			2 ²		
		$I_{OUT} = 150\text{mA}$		45			
		$I_{OUT} = 150\text{mA}$, $T_{AMB} = -40$ to 125°C			100		
SVR	Supply Voltage Rejection (Figure 4)	$V_{IN} = V_{OUT(NOM)} + 0.25\text{V}$, $V_{RIPPLE} = 0.1\text{V}$, $I_{OUT} = 50\text{mA}$, $f = 1\text{kHz}$		55		dB	
		$V_{IN} = V_{OUT(NOM)} + 0.25\text{V}$, $V_{RIPPLE} = 0.1\text{V}$, $I_{OUT} = 50\text{mA}$, $f = 10\text{kHz}$		50			
ISC	Short Circuit Current	$R_{LOAD} = 0\Omega$		500		mA	
$I_{OUT(PK)}$	Peak Output Current	$V_{OUT} \geq V_{OUT(NOM)} - 5\%$	300	480		mA	

Table 3. Electrical Characteristics (Continued)

Symbol	Parameter	Conditions	Min	Typ	Max	Unit
VEN	Enable Input Logic Low	$V_{IN} = 2.5V$ to $5.5V$, $T_{AMB} = -40$ to $125^{\circ}C$ ⁴			0.4	V
	Enable Input Logic High		1.2			
IEN	Enable Input Current	$V_{EN} = 0.4V$, $V_{IN} = 5.5V$		$\pm 10^2$		nA
eN	Output Noise Voltage	$BW = 10Hz$ to $100kHz$, $C_{OUT} = 1\mu F$, $I_{OUT} = 0mA$		30		μV_{RMS}
ton	Turn On Time ⁵	$C_{BYPASS} = 10nF$		160	250	μs
TSHDN	Thermal Shutdown ^{4, 6}			160		$^{\circ}C$
Recommended Output Capacitor						
COUT	Output Capacitor	Capacitance	1		22^2	μF
		ESR	0.005		5	Ω

1. Temperature variations are included within the output voltage accuracy. The line and load regulation tests will be indirectly tested and covered by the total accuracy test.
2. Guaranteed by Design.
3. Dropout voltage is the input-to-output voltage difference at which the output voltage is 100mV below its nominal value (does not apply to input voltages below 2.5V).
4. ENx must be driven with a $t_R = t_F < 10ms$.
5. Turn on time is time measured between the enable input just exceeding the V_{INH} high value and the output voltage just reaching 95% of its nominal value. Maximum limit guaranteed by design.
6. Typical thermal protection hysteresis is $20^{\circ}C$.

Note: All limits are guaranteed. The parameters with min and max values are guaranteed with production tests or SQC (Statistical Quality Control) methods.

Figure 3. AC Line Regulation Input Voltage Test Signal

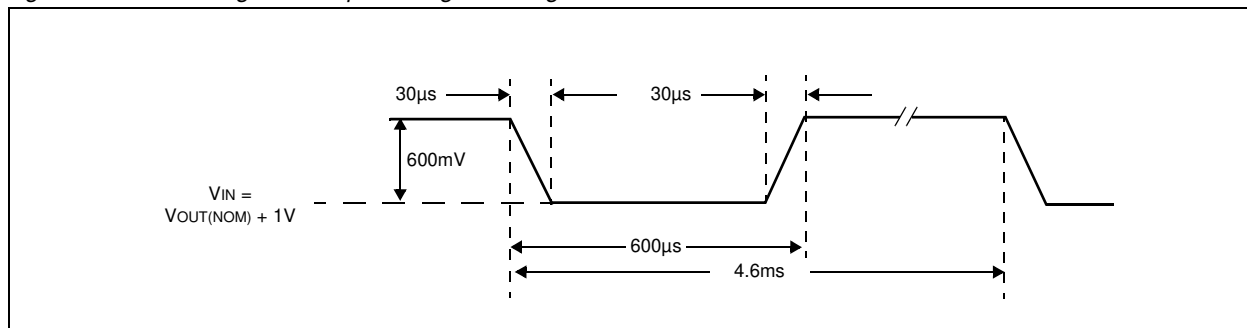
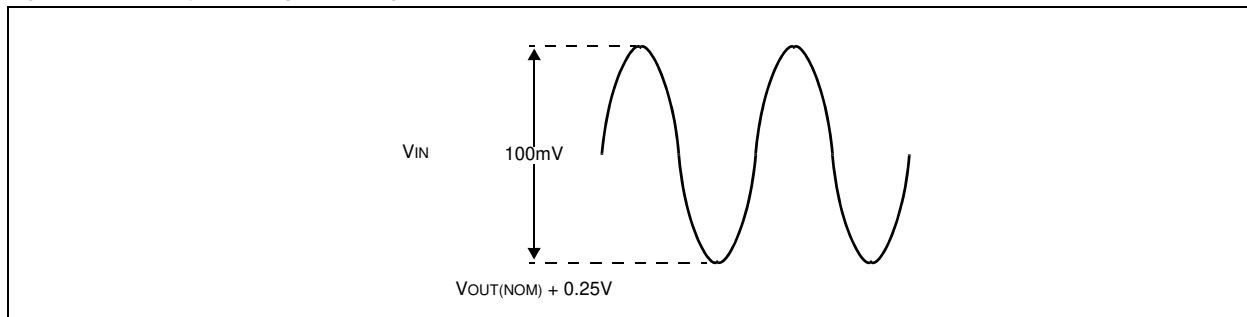

Figure 4. SVR Input Voltage Test Signal



7 Typical Operating Characteristics

$T_{AMB} = +25^{\circ}\text{C}$ (unless otherwise specified)

Figure 5. Output Voltage vs. Temperature;
 $V_{IN} = 3.3\text{V}$, $V_{SHDN} = 1.4\text{V}$, $I_{OUT} = 0\text{mA}$

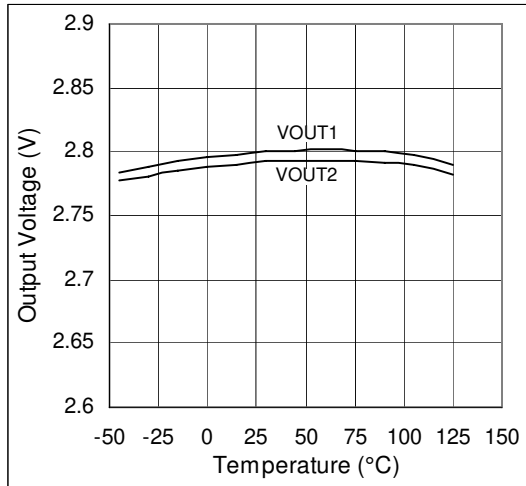

Figure 6. Output Voltage vs. Temperature;
 $V_{IN} = 3.3\text{V}$, $V_{SHDN} = 1.4\text{V}$, $I_{OUT} = 150\text{mA}$

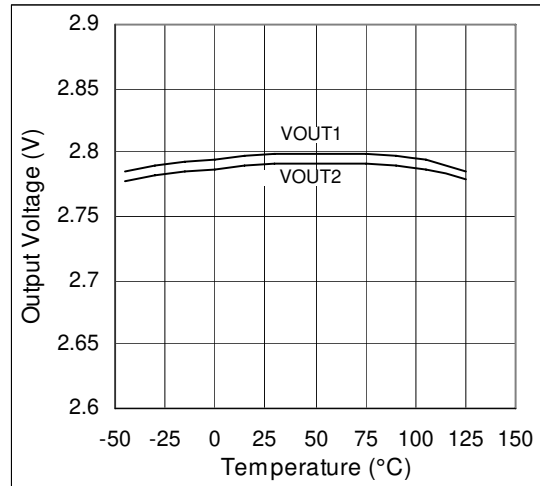

Figure 7. Load Regulation vs. Temperature;
 $V_{IN} = 3.3\text{V}$, $V_{SHDN} = 1.4\text{V}$, $I_{OUT} = 1$ to 150mA

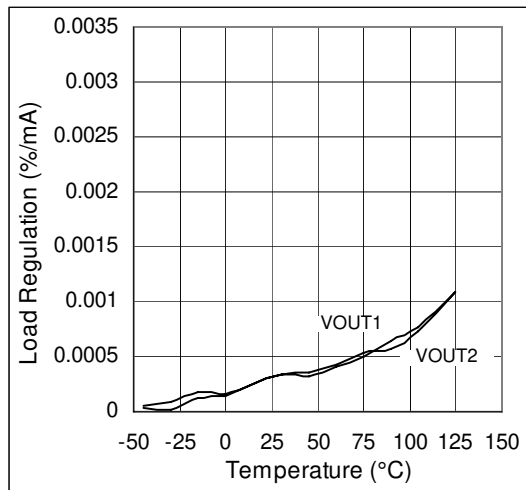

Figure 8. Line Regulation vs. Temperature;
 $V_{IN} = 3.3$ to 4.5V , $V_{SHDN} = 1.4\text{V}$, $I_{OUT} = 1\text{mA}$

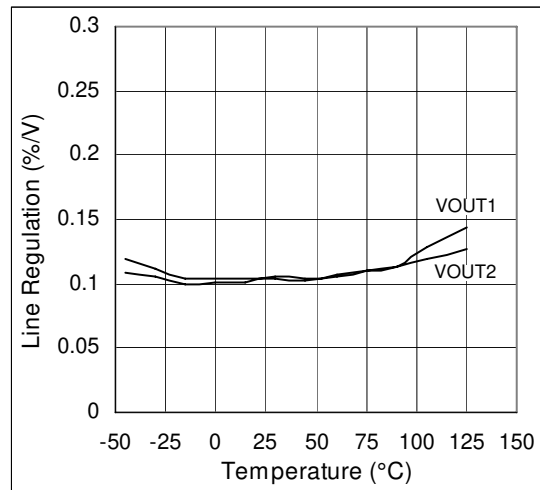

Figure 9. Quiescent Current vs. Temperature;
 $V_{OUT} = 2.8\text{V}$, $V_{IN} = 3.3\text{V}$, $I_{OUT} = 150\text{mA}$, $V_{SHDN} = 1.4\text{V}$

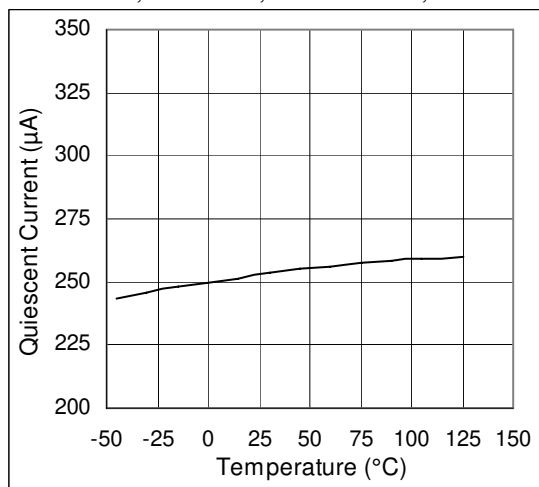

Figure 10. Quiescent Current vs. Temperature;
 $V_{OUT} = 2.8\text{V}$, $V_{IN} = 3.3\text{V}$, $I_{OUT} = 0\text{mA}$, $V_{SHDN} = 1.4\text{V}$

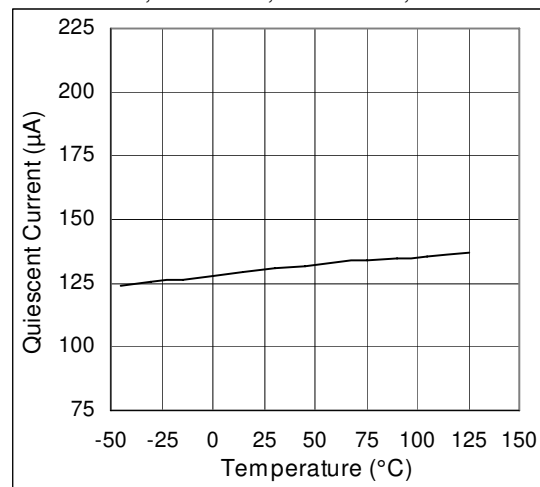

Figure 11. Line Transient Response; $V_{IN} = 3.8$ to $4.4V$, $I_{OUT} = 150mA$, $C_{IN} = C_{OUT} = 1\mu F$, $V_{OUT} = 2.8V$
 $C_{BYPASS} = 10nF$, Rise Time/Fall Time = $1\mu s$

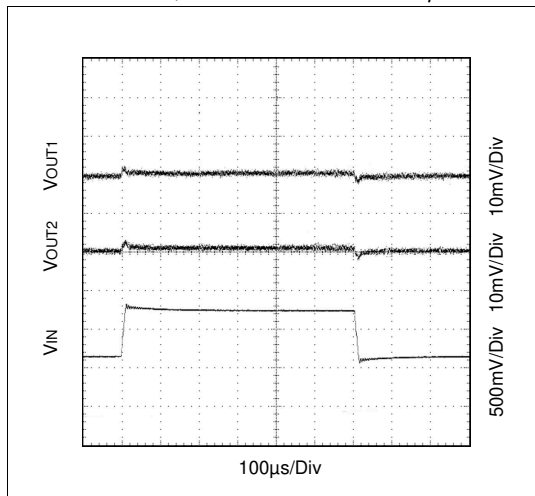

Figure 12. Load Transient Responses; $V_{IN} = 3.3V$, $C_{BYPASS} = 10nF$, $C_{IN} = C_{OUT} = 1\mu F$ (Ceramic), $t_R = 20ns$, $I_{OUT} = 1mA$, $V_{OUT} = 2.8V$

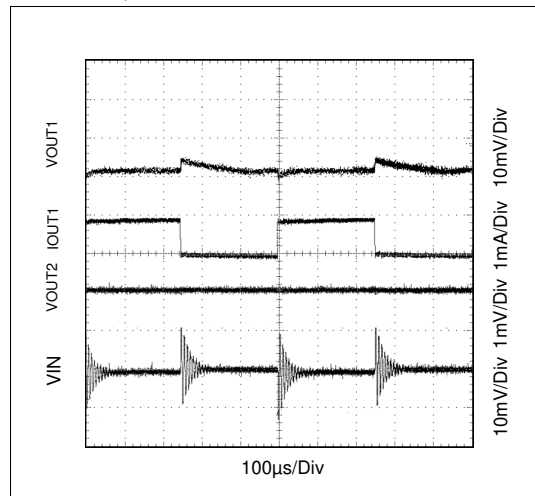

Figure 13. Turn On Time; $V_{IN} = 3.3V$, $I_{OUT1} = I_{OUT2} = 150mA$, $C_{IN} = C_{OUT} = 1\mu F$, $V_{OUT} = 2.8V$
 $C_{BYPASS} = 10nF$, Rise Time/Fall Time = $1\mu s$

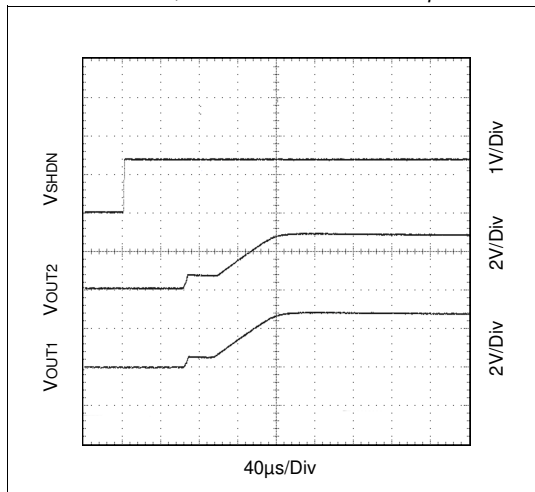
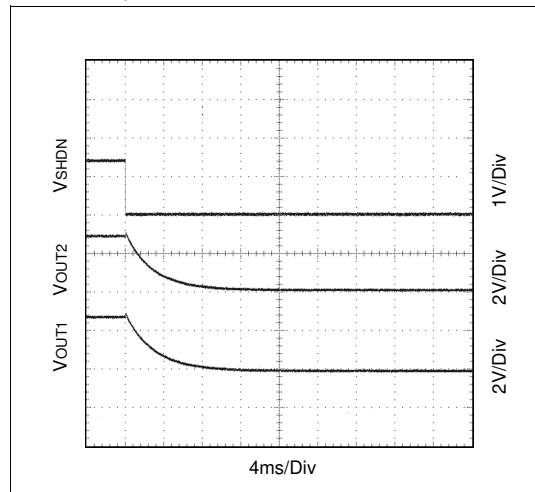

Figure 14. Turn Off Time; $V_{IN} = 3.3V$, $C_{BYPASS} = 10nF$, $C_{IN} = C_{OUT} = 1\mu F$ (Ceramic), $t_R = 20ns$, $I_{OUT} = 1mA$, $V_{OUT} = 2.8V$



8 Detailed Description

Regulator On/Off Operation

The AS13986 outputs (V_{OUT1} and V_{OUT2}) are enabled by pulling the corresponding ENx pin high (1.4V) and disabled by pulling the ENx pin low (0V). For reliable operation, the signal source used to drive the ENx input must be capable of swinging above and below the specified turn-on/off voltage thresholds listed in [Table 3 on page 4](#) (Enable Input Logic Low and Enable Input Logic High parameters).

Note: Reliable enable/disable operation of V_{OUT1} and V_{OUT2} is guaranteed by driving the ENx pins with t_R and $t_F = 10\text{ms}$.

Fast Turn-On Time

In normal operation, the AS13986 outputs are turned on when V_{REF} reaches its regulated value (1.23V nominal). Turn-on time is decreased by charging the capacitor at pin BYPASS with the internal $70\mu\text{A}$ current source. The current source is turned off when the bandgap voltage reaches approximately 95% of its regulated value.

Turn-on time is determined by the time constant of the bypass capacitor; smaller capacitor values decrease turn-on time, although noise reduction decreases as well. Therefore, turn-on time and noise reduction must be taken into consideration when choosing the value of the bypass capacitor.

9 Application Information

Figure 15. Typical Application Diagram

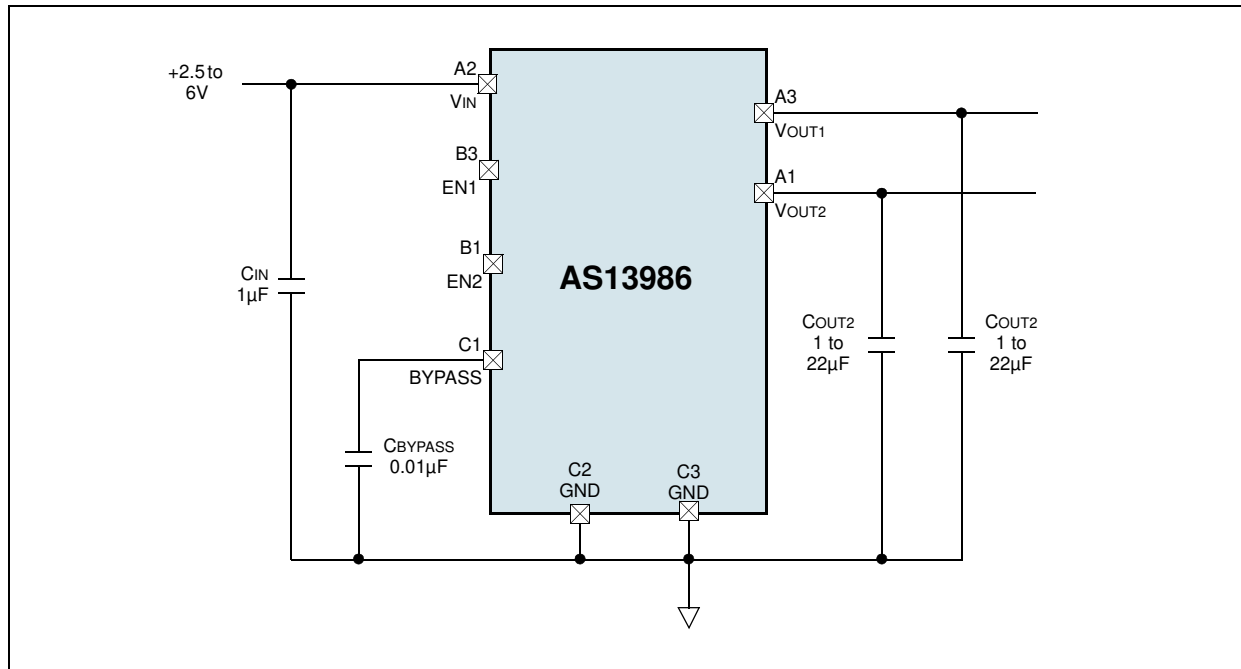

Current Limit

The AS13986 features integrated short-circuit protection and a current limiting circuitry which controls the pass transistor gate voltage, limiting output current to approximately 500mA.

Thermal Overload Protection

On-chip thermal overload protection limits total power dissipation in the AS13986. When the junction temperature (T_J) exceeds $+160^\circ\text{C}$, the thermal sensor sends a signal to the shutdown logic, turning off the pass transistors and allowing the device to cool down. The pass transistors will turn on again when the junction temperature cools by 20°C (typ), resulting in a pulsed output during continuous thermal overload conditions.

Power Dissipation

Maximum power dissipation of the AS13986 depends on the thermal resistance of the case and PCB, the temperature difference between the die junction and ambient air, and the rate of air flow. The power dissipated by the AS13986 is calculated as:

$$PD = IO (VIN - VOUT) \quad (EQ 1)$$

The maximum power dissipation is:

$$P_{MAX} = (T_{J(MAX)} - T_{AMB})/R_{TH} \quad (EQ 2)$$

Where:

$T_{J(MAX)} = +125^\circ\text{C}$

T_{AMB} is the ambient temperature.

R_{TH} is the thermal resistance.

External Component Selection

Input Capacitor

A ceramic, tantalum, or film capacitor of 1 μF (typ) should be used between pin V_{IN} and GND (the value of the capacitor may be increased without limit). This capacitor must be located a distance of not more than 1 cm from V_{IN} , and returned to a clean analog ground (see Figure 15).

Note: Tantalum capacitors can suffer catastrophic failures due to surge current when connected to a low impedance source of power (like a battery or a very large capacitor). If a tantalum capacitor is used at the input, it must be guaranteed by the manufacturer to have a surge current rating sufficient for the application. There are no requirements for the ESR on the input capacitor, but tolerance and temperature coefficient must be considered when selecting the capacitor to ensure the capacitance will be approximately 1 μF over the entire operating temperature range.

Output Capacitor

The AS13986 was specifically designed to use very small ceramic output capacitors (temperature characteristics X7R, X5R, Z5U or Y5V) in 1 to 22 μF range (ESR of 0.005 to 5 Ω). Tantalum or film capacitors can be used at the output, however these types of capacitors require more PCB space and are more expensive than ceramic capacitors.

Note: The output capacitor must meet the minimum capacitance requirement and also have an ESR value which is within a stable range.

Bypass Capacitor

Noise on both regulator outputs (V_{OUT1} and V_{OUT2}) can be significantly reduced by connecting a 0.01 μF capacitor between pin BYPASS and GND (see Figure 15), with virtually no effect on the transient response of the AS13986. Using a bypass capacitor will also prevent output overshoot during start up. This capacitor should be connected directly to a high-impedance node in the band gap reference circuit. See also [Fast Turn-On Time on page 8](#).

Note: Any significant loading on the high-impedance node will effect the regulated output voltage. For this reason, DC leakage current through pin BYPASS must be kept as low as possible for best output voltage accuracy.

High-quality ceramic capacitors with NPO or COG dielectric are ideal as bypass capacitors as they typically exhibit very low leakage current. Polypropylene and polycarbonate film capacitors are also a good choice as these capacitors typically have extremely low leakage current and are available in small surface-mount packages.

Layout and Grounding Considerations

Well designed PC board layout is essential for optimizing device performance. In addition to providing electrical connections, the AS13986 pins also channel heat away from the die.

- Wide circuit-board traces and large, solid copper polygons should be used to improve power dissipation.
- Multiple vias to buried ground planes should be used to further enhance thermal conductivity.

10 Package Drawings and Markings

The device is available in an 8-pin WLP package.

Figure 16. 8-pin WLP Package

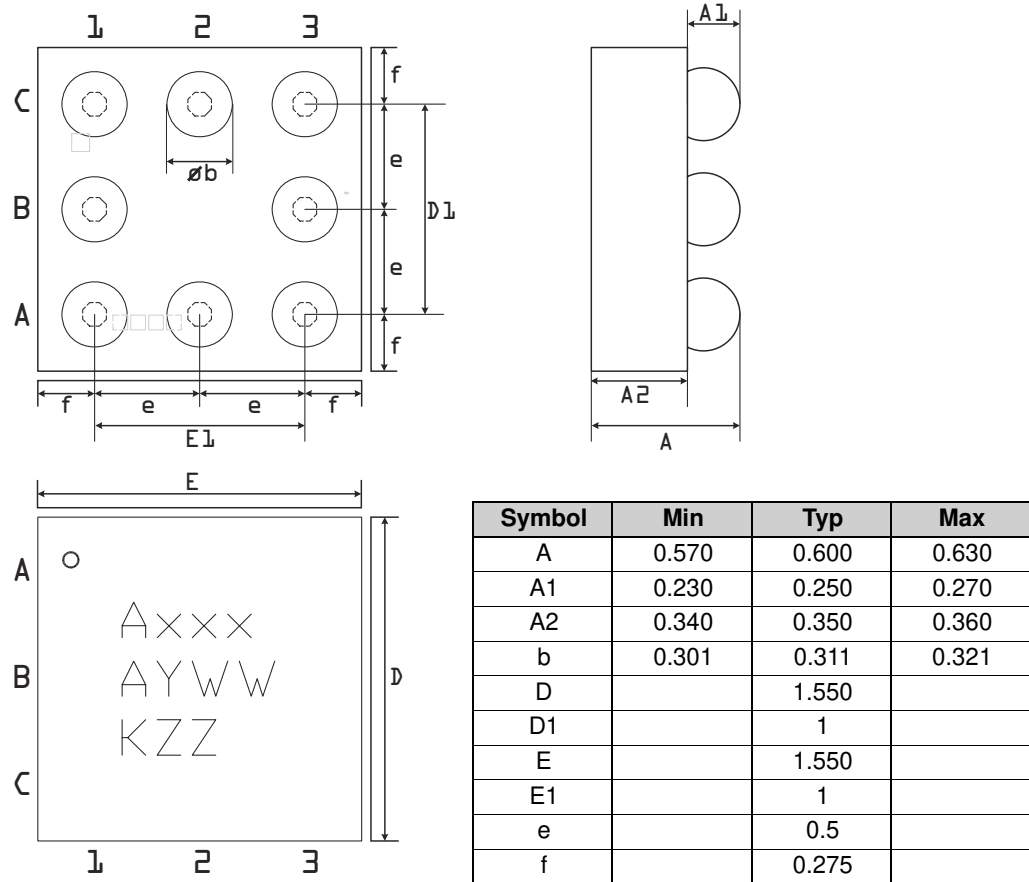

11 Ordering Information

The device is available as the standard products shown in [Table 4](#).

Table 4. Ordering Information

Ordering Code	Markings	Description	Delivery Form	Package
AS13986-2828-T	ASKP	Dual LDO 2.8V and 2.8V, 150mA	Tape and Reel	8-pin WLP
AS13986-1833-T	ASRL	Dual LDO 1.8V and 3.3V, 150mA	Tape and Reel	8-pin WLP
AS13986- <i>xxyy</i> -T ¹		Dual LDO, 150mA	Tape and Reel	8-pin WLP

1. *xx* is a placeholder for V_{OUT1}, 1.2V to 5.0V (in 50mV Steps).

yy is a placeholder for V_{OUT2}, 1.2V to 5.0V (in 50mV Steps).

Available upon request. For more information and inquiries contact <http://www.austriamicrosystems.com/contact>

Note: All products are RoHS compliant and Pb-free.

Buy our products or get free samples online at ICdirect: <http://www.austriamicrosystems.com/ICdirect>

For further information and requests, please contact us <mailto:sales@austriamicrosystems.com> or find your local distributor at <http://www.austriamicrosystems.com/distributor>

Copyrights

Copyright © 1997-2009, austriamicrosystems AG, Tobelbaderstrasse 30, 8141 Unterpremstaetten, Austria-Europe. Trademarks Registered ®. All rights reserved. The material herein may not be reproduced, adapted, merged, translated, stored, or used without the prior written consent of the copyright owner.

All products and companies mentioned are trademarks or registered trademarks of their respective companies.

Disclaimer

Devices sold by austriamicrosystems AG are covered by the warranty and patent indemnification provisions appearing in its Term of Sale. austriamicrosystems AG makes no warranty, express, statutory, implied, or by description regarding the information set forth herein or regarding the freedom of the described devices from patent infringement. austriamicrosystems AG reserves the right to change specifications and prices at any time and without notice. Therefore, prior to designing this product into a system, it is necessary to check with austriamicrosystems AG for current information. This product is intended for use in normal commercial applications. Applications requiring extended temperature range, unusual environmental requirements, or high reliability applications, such as military, medical life-support or life-sustaining equipment are specifically not recommended without additional processing by austriamicrosystems AG for each application. For shipments of less than 100 parts the manufacturing flow might show deviations from the standard production flow, such as test flow or test location.

The information furnished here by austriamicrosystems AG is believed to be correct and accurate. However, austriamicrosystems AG shall not be liable to recipient or any third party for any damages, including but not limited to personal injury, property damage, loss of profits, loss of use, interruption of business or indirect, special, incidental or consequential damages, of any kind, in connection with or arising out of the furnishing, performance or use of the technical data herein. No obligation or liability to recipient or any third party shall arise or flow out of austriamicrosystems AG rendering of technical or other services.



Contact Information

Headquarters

austriamicrosystems AG
Tobelbaderstrasse 30
A-8141 Unterpremstaetten, Austria

Tel: +43 (0) 3136 500 0
Fax: +43 (0) 3136 525 01

For Sales Offices, Distributors and Representatives, please visit:

<http://www.austriamicrosystems.com/contact>