



Chipsmall Limited consists of a professional team with an average of over 10 year of expertise in the distribution of electronic components. Based in Hongkong, we have already established firm and mutual-benefit business relationships with customers from,Europe,America and south Asia,supplying obsolete and hard-to-find components to meet their specific needs.

With the principle of “Quality Parts,Customers Priority,Honest Operation,and Considerate Service”,our business mainly focus on the distribution of electronic components. Line cards we deal with include Microchip,ALPS,ROHM,Xilinx,Pulse,ON,Everlight and Freescale. Main products comprise IC,Modules,Potentiometer,IC Socket,Relay,Connector.Our parts cover such applications as commercial,industrial, and automotives areas.

We are looking forward to setting up business relationship with you and hope to provide you with the best service and solution. Let us make a better world for our industry!



Contact us

Tel: +86-755-8981 8866 Fax: +86-755-8427 6832

Email & Skype: info@chipsmall.com Web: www.chipsmall.com

Address: A1208, Overseas Decoration Building, #122 Zhenhua RD., Futian, Shenzhen, China



DATA SHEET

AS183-92/AS183-92LF: 300 kHz-2.5 GHz pHEMT GaAs SPDT Switch

Applications

- General purpose medium-power switches in telecommunication applications
- Transmit/receive switches in 802.11 b/g WLAN Bluetooth™ systems

Features

- IP1dB: +30 dBm typical @ 3 V
- IP3: +43 dBm typical @ 3 V
- Low insertion loss: 0.3 dB @ 0.9 GHz
- Low DC power consumption
- Ultra-miniature, SC-70 (6-pin, 2.00 x 1.25 mm) package (MSL1, 260 °C per JEDEC J-STD-020)



Skyworks Green™ products are compliant with all applicable legislation and are halogen-free. For additional information, refer to *Skyworks Definition of Green™*, document number SQ04-0074.

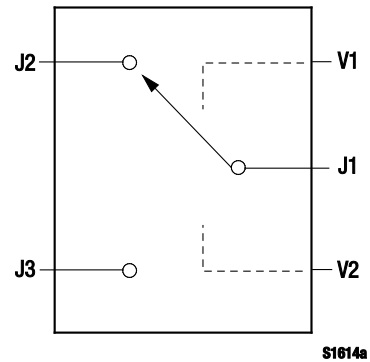

Figure 1. AS183-92/AS183-92LF Block Diagram

Description

The AS183-92/AS183-92LF is a pHEMT GaAs FET Single Pole Double Throw (SPDT) switch. The device features low insertion loss and positive voltage operation with very low DC power consumption. The AS183-92/AS183-92LF is manufactured in a compact, low-cost 2.00 x 1.25 mm, 6-pin SC-70 package.

A functional block diagram is shown in Figure 1. The pin configuration and package are shown in Figure 2. Signal pin assignments and functional pin descriptions are provided in Table 1.

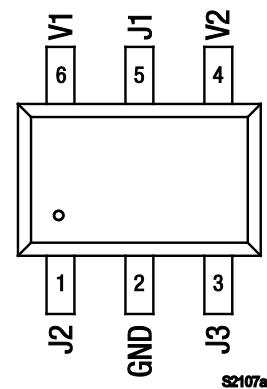

Figure 2. AS183-92/AS183-92LF Pinout –6-Pin SC-70 (Top View)

Table 1. AS183-92/AS183-92LF Signal Descriptions

Pin #	Name	Description	Pin #	Name	Description
1	J2	RF input/output 2 (Note 1)	4	V2	DC control voltage
2	GND	Ground	5	J1	RF input/output 1 (Note 1)
3	J3	RF input/output 3 (Note 1)	6	V1	DC control voltage

Note 1: A 100 pF blocking capacitor is required for >500 MHz operation. Use larger value capacitors for lower frequency operation.

Table 2. AS183-92/AS183-92LF Absolute Maximum Ratings

Parameter	Symbol	Minimum	Maximum	Units
Control voltage	V _{CTL}	-0.2	+8.0	V
RF input power (V _{CTL} = 0 to 7 V) @ >500 MHz	P _{IN}		6	W
Operating temperature	T _{OP}	-40	+85	°C
Storage temperature	T _{STG}	-65	+150	°C

Note: Exposure to maximum rating conditions for extended periods may reduce device reliability. There is no damage to device with only one parameter set at the limit and all other parameters set at or below their nominal value.

CAUTION: Although this device is designed to be as robust as possible, Electrostatic Discharge (ESD) can damage this device. This device must be protected at all times from ESD. Static charges may easily produce potentials of several kilovolts on the human body or equipment, which can discharge without detection. Industry-standard ESD precautions should be used at all times.

Electrical and Mechanical Specifications

The absolute maximum ratings of the AS183-92/AS183-92LF are provided in Table 2. Electrical specifications are provided in Table 3.

Performance characteristics for the AS183-92/AS183-92LF are illustrated in Figures 3 through 5.

The state of the AS183-92/AS183-92LF is determined by the logic provided in Table 4.

Table 3. AS183-92/AS183-92LF Electrical Specifications (Note 1)
(V_{CTL} = 0 to 3 V, T_{OP} = +25 °C, Characteristic Impedance = 50 Ω, Unless Otherwise Noted)

Parameter	Symbol	Test Condition	Min	Typical	Max	Units
Insertion loss (Note 2)		300 kHz to 1.0 GHz		0.30	0.40	dB
		300 kHz to 2.0 GHz		0.30	0.40	dB
		300 kHz to 2.5 GHz		0.55	0.60	dB
Isolation		300 kHz to 1.0 GHz	18	20		dB
		300 kHz to 2.0 GHz	12	14		dB
		300 kHz to 2.5 GHz	11	13		dB
Voltage Standing Wave Ratio (Note 3)	VSWR	300 kHz to 2.5 GHz		1.2:1	1.6:1	–
Switching characteristics: Rise/fall On/off Video feedthrough		10/90% or 90/10% RF		10		ns
		50% control to 90/10% RF		20		ns
		T _{RISE} = 1 ns, bandwidth = 500 MHz		25		mV
1 dB Input Compression Point	IP1dB	@ 0.5 to 2.5 GHz V _{CTL} = 0 to 3 V V _{CTL} = 0 to 5 V		+30 +34		dBm dBm
3 rd Order Intercept Point	IP3	@ 0.5 to 2.5 GHz, for two-tone P _{IN} = +15 dBm V _{CTL} = 0 to 3 V V _{CTL} = 0 to 5 V		+43 +50		dBm dBm
Thermal resistance				25		°C/W
Control voltage: Low (@ 20 μA max) High (@ 100 μA max) High (@ 200 μA max)	V _{CTL_L}		0		0.2	V
	V _{CTL_H}				3.0	V
	V _{CTL_H}				5.0	V

Note 1: Performance is guaranteed only under the conditions listed in this Table.

Note 2: Insertion loss changes by 0.003 dB/°C.

Note 3: Insertion loss state.

Typical Performance Characteristics

($V_{CTL} = 0$ to -3 V, $T_{OP} = +25$ °C, Characteristic Impedance [Z_0] = 50Ω , Unless Otherwise Noted)

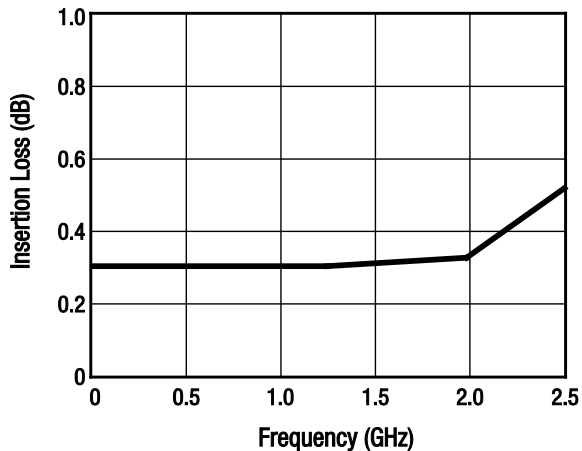

Figure 3. Insertion Loss vs Frequency

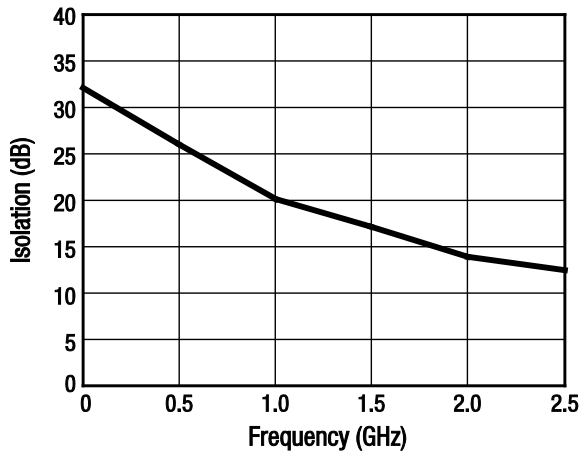

Figure 4. Isolation vs Frequency

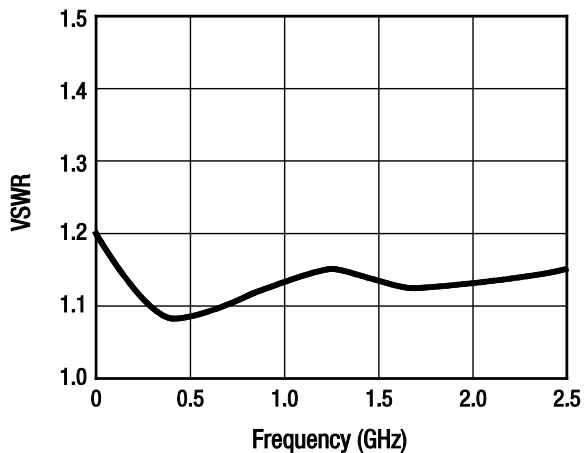

Figure 5. VSWR vs Frequency

Table 4. Truth Table ($V_{HIGH} = 3$ to 5 V)

V1	V2	J1-J2	J1-J3
V_{HIGH}	0	Insertion loss	Isolation
0	V_{HIGH}	Isolation	Insertion loss

Note: Any state other than described in this Table places the device in an undefined state and is not recommended.

Evaluation Board Description

The AS183-92/AS183-92LF Evaluation Board is used to test the performance of the AS183-92/AS183-92LF SPDT switch. An Evaluation Board schematic diagram is provided in Figure 6. An assembly drawing for the Evaluation Board is shown in Figure 7.

Package Dimensions

The PCB layout footprint for the AS183-92/AS183-92LF is provided in Figure 8. Typical case markings are shown in Figure 9. Package dimensions for the 6-pin SC-70 are shown in Figure 10, and tape and reel dimensions are provided in Figure 11.

Package and Handling Information

Instructions on the shipping container label regarding exposure to moisture after the container seal is broken must be followed. Otherwise, problems related to moisture absorption may occur when the part is subjected to high temperature during solder assembly.

The AS183-92/AS183-92LF is rated to Moisture Sensitivity Level 1 (MSL1) at 260 °C. It can be used for lead or lead-free soldering. It can be used for lead or lead-free soldering. For additional information, refer to the Skyworks Application Note, *Solder Reflow Information*, document number 200164.

Care must be taken when attaching this product, whether it is done manually or in a production solder reflow environment. Production quantities of this product are shipped in a standard tape and reel format.

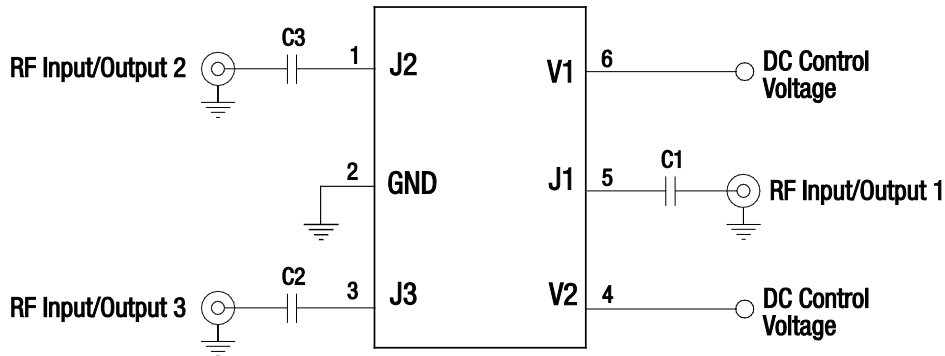

Note: Use 100 pF blocking capacitors (C1, C2, C3) for >500 MHz operation. Higher values recommended for lower frequency operation. Exposed paddle must be grounded.

Use 10 nF blocking capacitors (C1, C2, C3) for <50 MHz operation.

S2108a

Figure 6. AS183-92/AS183-92LF Evaluation Board Schematic

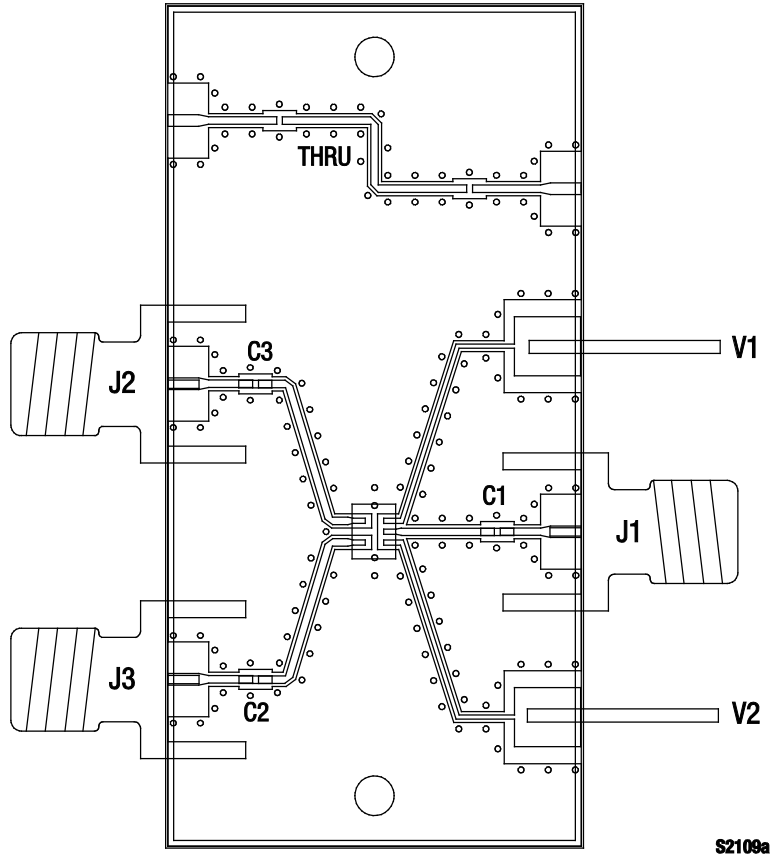

Figure 7. AS183-92/AS183-92LF Evaluation Board Assembly Diagram

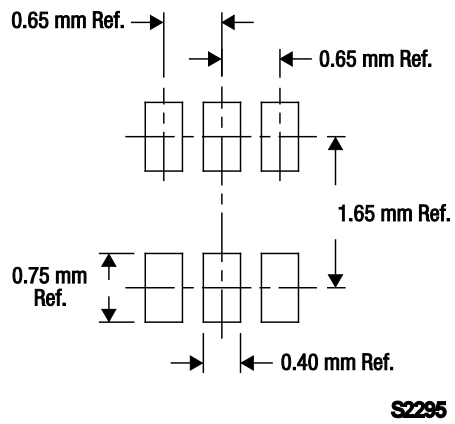

Figure 8. AS183-92/AS183-92LF PCB Layout Footprint (Top View)

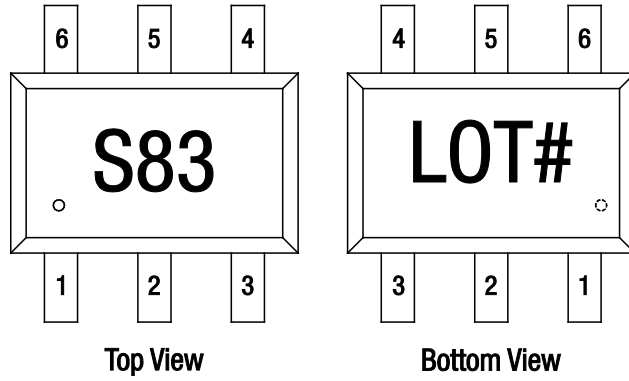
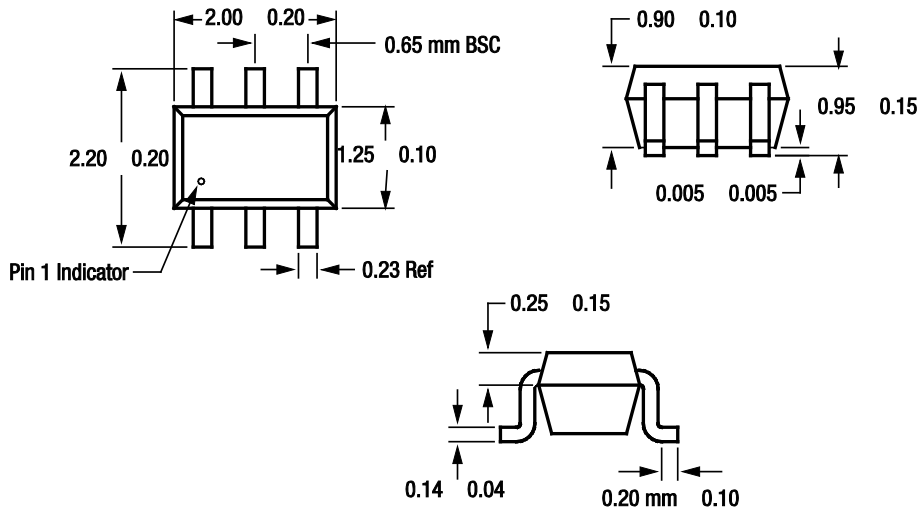

Figure 9. Typical Case Markings



All measurements are in millimeters

Dimensioning and tolerancing according to ASME Y14.5M-1994

S1479

Figure 10. AS183-92/AS183-92LF 6-Pin SC-70 Package Dimensions

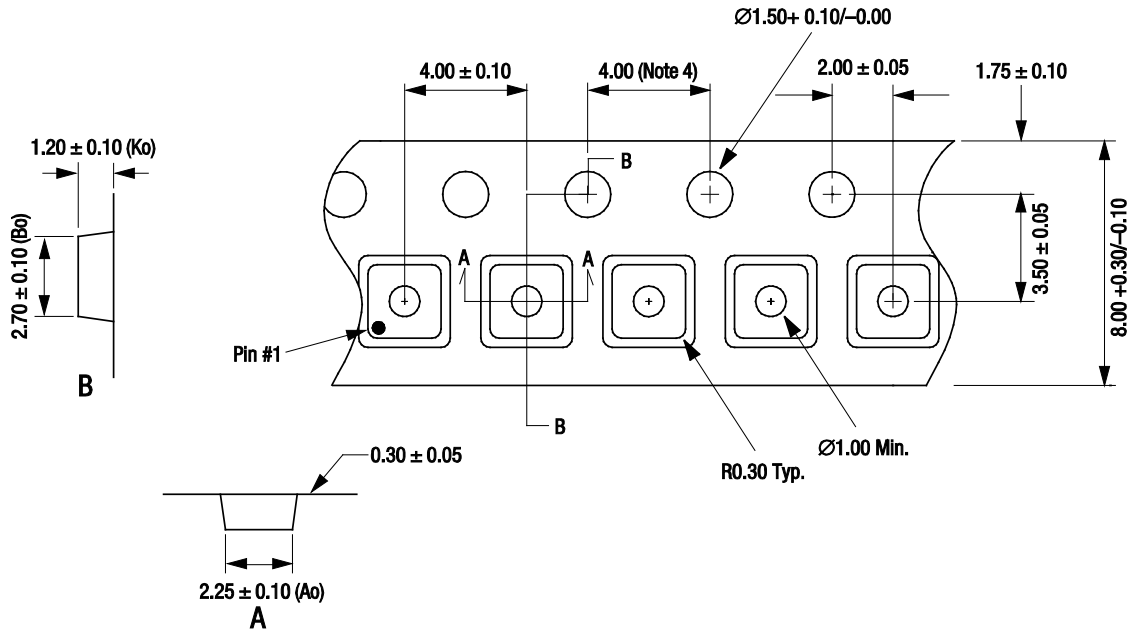

- Notes:
1. Carrier tape: black conductive polystyrene.
 2. Cover tape material: transparent conductive HSA.
 3. Cover tape size: 5.40 mm width.
 4. Ten sprocket hole pitch cumulative tolerance ± 0.20 mm.
 5. All measurements are in millimeters.

S1681

Figure 11. AS183-92/AS183-92LF Tape and Reel Dimensions

Ordering Information

Model Name	Manufacturing Part Number	Evaluation Board Part Number
AS183-92/AS183-92LF SPDT Switch	AS183-92/AS183-92LF	AS183-92/AS183-92LF-EVB

Copyright © 2002-2005, 2011 Skyworks Solutions, Inc. All Rights Reserved.

Information in this document is provided in connection with Skyworks Solutions, Inc. ("Skyworks") products or services. These materials, including the information contained herein, are provided by Skyworks as a service to its customers and may be used for informational purposes only by the customer. Skyworks assumes no responsibility for errors or omissions in these materials or the information contained herein. Skyworks may change its documentation, products, services, specifications or product descriptions at any time, without notice. Skyworks makes no commitment to update the materials or information and shall have no responsibility whatsoever for conflicts, incompatibilities, or other difficulties arising from any future changes.

No license, whether express, implied, by estoppel or otherwise, is granted to any intellectual property rights by this document. Skyworks assumes no liability for any materials, products or information provided hereunder, including the sale, distribution, reproduction or use of Skyworks products, information or materials, except as may be provided in Skyworks Terms and Conditions of Sale.

THE MATERIALS, PRODUCTS AND INFORMATION ARE PROVIDED "AS IS" WITHOUT WARRANTY OF ANY KIND, WHETHER EXPRESS, IMPLIED, STATUTORY, OR OTHERWISE, INCLUDING FITNESS FOR A PARTICULAR PURPOSE OR USE, MERCHANTABILITY, PERFORMANCE, QUALITY OR NON-INFRINGEMENT OF ANY INTELLECTUAL PROPERTY RIGHT; ALL SUCH WARRANTIES ARE HEREBY EXPRESSLY DISCLAIMED. SKYWORKS DOES NOT WARRANT THE ACCURACY OR COMPLETENESS OF THE INFORMATION, TEXT, GRAPHICS OR OTHER ITEMS CONTAINED WITHIN THESE MATERIALS. SKYWORKS SHALL NOT BE LIABLE FOR ANY DAMAGES, INCLUDING BUT NOT LIMITED TO ANY SPECIAL, INDIRECT, INCIDENTAL, STATUTORY, OR CONSEQUENTIAL DAMAGES, INCLUDING WITHOUT LIMITATION, LOST REVENUES OR LOST PROFITS THAT MAY RESULT FROM THE USE OF THE MATERIALS OR INFORMATION, WHETHER OR NOT THE RECIPIENT OF MATERIALS HAS BEEN ADVISED OF THE POSSIBILITY OF SUCH DAMAGE.

Skyworks products are not intended for use in medical, lifesaving or life-sustaining applications, or other equipment in which the failure of the Skyworks products could lead to personal injury, death, physical or environmental damage. Skyworks customers using or selling Skyworks products for use in such applications do so at their own risk and agree to fully indemnify Skyworks for any damages resulting from such improper use or sale.

Customers are responsible for their products and applications using Skyworks products, which may deviate from published specifications as a result of design defects, errors, or operation of products outside of published parameters or design specifications. Customers should include design and operating safeguards to minimize these and other risks. Skyworks assumes no liability for applications assistance, customer product design, or damage to any equipment resulting from the use of Skyworks products outside of stated published specifications or parameters.

Skyworks, the Skyworks symbol, and "Breakthrough Simplicity" are trademarks or registered trademarks of Skyworks Solutions, Inc., in the United States and other countries. Third-party brands and names are for identification purposes only, and are the property of their respective owners. Additional information, including relevant terms and conditions, posted at www.skyworksinc.com, are incorporated by reference.