



Chipsmall Limited consists of a professional team with an average of over 10 year of expertise in the distribution of electronic components. Based in Hongkong, we have already established firm and mutual-benefit business relationships with customers from,Europe,America and south Asia,supplying obsolete and hard-to-find components to meet their specific needs.

With the principle of “Quality Parts,Customers Priority,Honest Operation,and Considerate Service”,our business mainly focus on the distribution of electronic components. Line cards we deal with include Microchip,ALPS,ROHM,Xilinx,Pulse,ON,Everlight and Freescale. Main products comprise IC,Modules,Potentiometer,IC Socket,Relay,Connector.Our parts cover such applications as commercial,industrial, and automotives areas.

We are looking forward to setting up business relationship with you and hope to provide you with the best service and solution. Let us make a better world for our industry!



Contact us

Tel: +86-755-8981 8866 Fax: +86-755-8427 6832

Email & Skype: info@chipsmall.com Web: www.chipsmall.com

Address: A1208, Overseas Decoration Building, #122 Zhenhua RD., Futian, Shenzhen, China



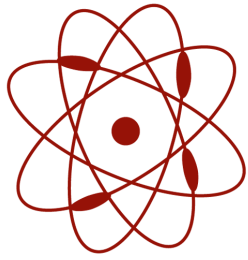

pui
audio™ inc
a projects unlimited company

ASE04508MR-LW150-R 45mm Enclosed Speaker

3541 Stop Eight Road • Dayton, Ohio 45414

Product Overview

- 30 x 25mm speaker with 150mm lead wires for instant integration
- 3W continuous, 5 maximum power handling and 8Ω impedance
- Rugged ABS enclosure designed for optimum sound

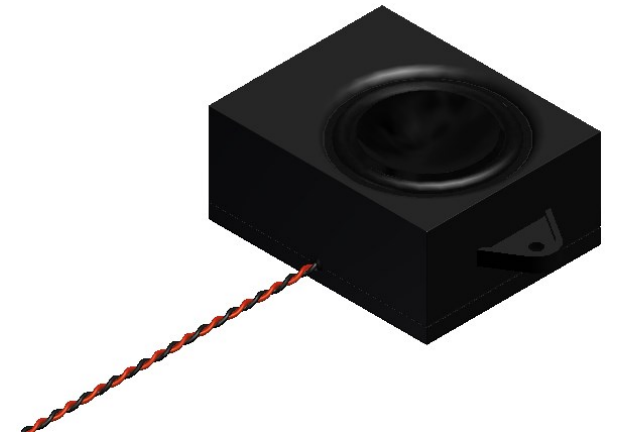

Frequency Response (1W @ 0.5 meters)

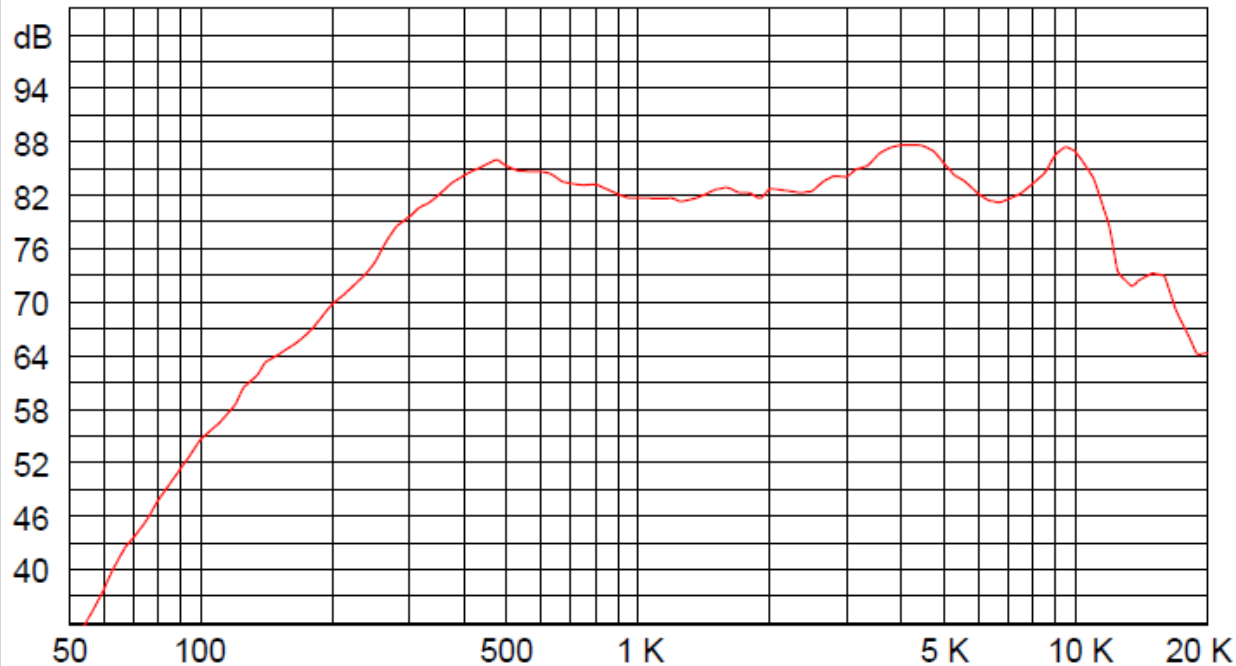

An Initiative of the EPC and CeSI



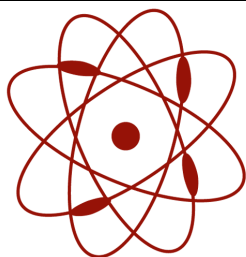

pui
audio™
a projects unlimited company

ASE04508MR-LW150-R

45mm Enclosed Speaker

Mechanical and Environment Testing

Test Description	Test Condition
High Temperature	60°C ±2°C with random humidity for 96 hours
Low Temperature	-25°C ±2°C with random humidity for 96 hours
Humidity	40°C ±3°C with 90% to 95% relative humidity for 96 hours
Vibration	1.5 mm movement modulated at 10 to 55 Hz for 2 hours
Drop Test	75 cm free fall onto concrete floor, 10 cycles
Temperature Cycle Test	-25°C to 60°C, 4 cycles (refer to Temperature Cycle Test Graph)

After tests, speaker shall rest for 1 hours. SPL shall not deviate ±4 dB from pre-test measurement.

Temperature Cycle Test Graph

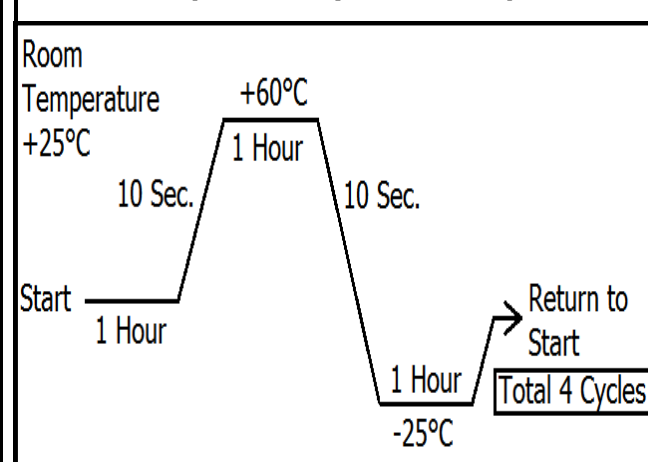

Frequency Response and SPL Measurement Setup

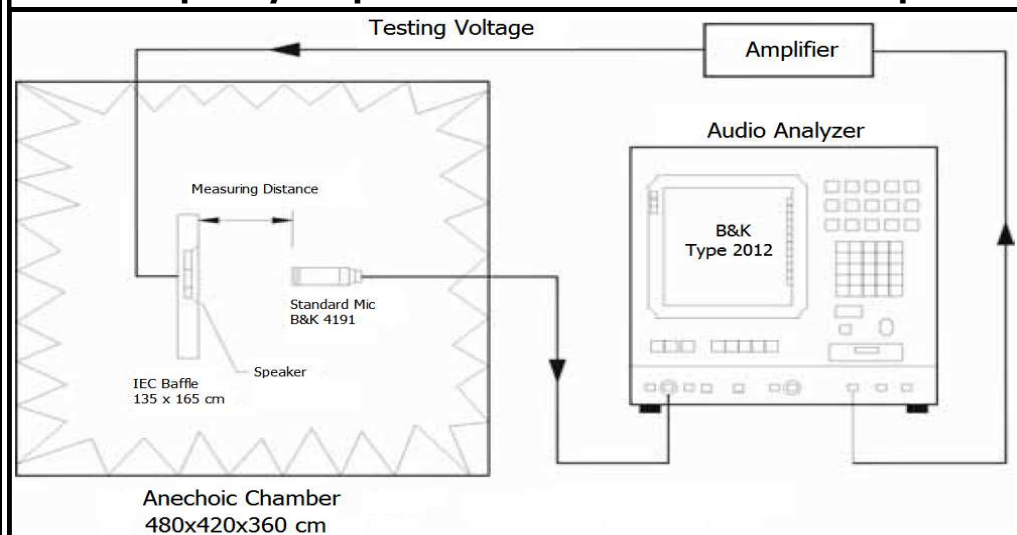

Speaker Parameters

Specification	ASE04508MR
Fo (Hz)	280
Frequency Range	250 ~ 12,000
Impedance (ohm)	8
SPL (dB) @ 1W/0.5m	82

SPECIFICATIONS

PARAMETERS	VALUES	UNITS
RATED INPUT POWER	3	W
MAX INPUT POWER	5	W
IMPEDANCE	8 ± 15%	OHM
OUTPUT SPL @ 1W/0.5M (AT 0.8, 1.0, 1.2, 1.5 kHz)	82 ± 3	dBA
DISTORTION (MAX.)	5%	-
RESONANT FREQUENCY	280 ± 20%	Hz
FREQUENCY RANGE	250 ~ 12,000	Hz
HOUSING MATERIAL	ABS	-
CONE MATERIAL	MYLAR	-
MAGNET MATERIAL	RARE EARTH	-
OPERATING TEMPERATURE	-25 ~ +60	°C
WEIGHT	27	grams

THIS DOCUMENT CONTAINS DATA PROPRIETARY TO PROJECTS UNLIMITED, INC. ANY USE OR REPRODUCTION, IN ANY FORM, WITHOUT PRIOR WRITTEN PERMISSION OF PROJECTS UNLIMITED, INC. IS PROHIBITED.
©2003, Projects Unlimited Inc.

REVISION HISTORY

LTR	DESCRIPTION	DATE	APPROVED
-	RELEASED FROM ENGINEERING	1/23/2014	

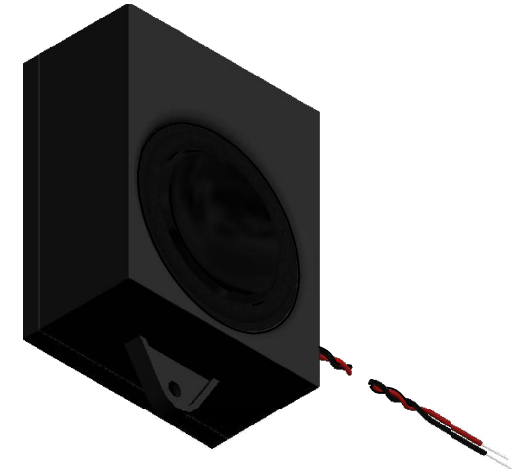
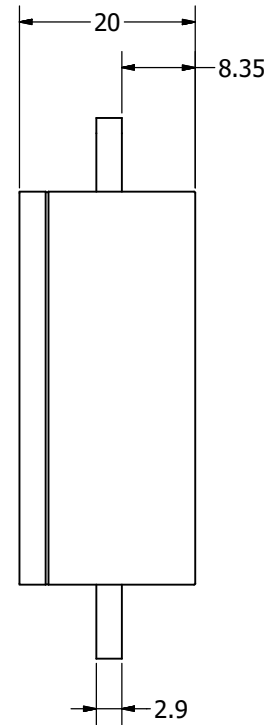
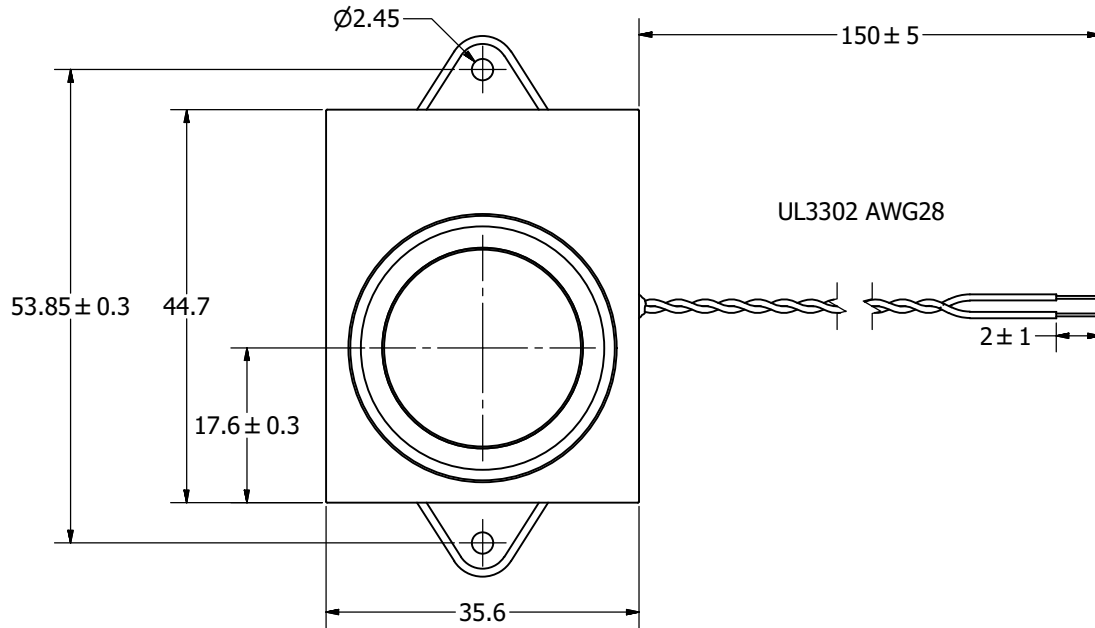

NOTES:

1. ALL DIMENSIONS ARE IN MILLIMETERS.
2. SPECIFICATIONS SUBJECT TO CHANGE OR WITHDRAWAL WITHOUT NOTICE.
3. THIS PART IS RoHS 2011/65/EU COMPLIANT.

UNLESS OTHERWISE SPECIFIED: DIMENSIONS ARE IN MILLIMETERS, TOLERANCES ARE ±0.5 AND ANGLES ARE ±3°.	SIZE A3	Designed by	Date	Checked by	Date	Approved by	Date	Drawn Date
		J.D.	1/17/2014	M.L.	1/17/2014	B.R.	1/17/2014	1/17/2014
ASE04508MR-LW150-R.idw		 ASE04508MR-LW150-R Speaker				Edition	Sheet	
						-	1 / 1	