



Chipsmall Limited consists of a professional team with an average of over 10 year of expertise in the distribution of electronic components. Based in Hongkong, we have already established firm and mutual-benefit business relationships with customers from,Europe,America and south Asia,supplying obsolete and hard-to-find components to meet their specific needs.

With the principle of “Quality Parts,Customers Priority,Honest Operation,and Considerate Service”,our business mainly focus on the distribution of electronic components. Line cards we deal with include Microchip,ALPS,ROHM,Xilinx,Pulse,ON,Everlight and Freescale. Main products comprise IC,Modules,Potentiometer,IC Socket,Relay,Connector.Our parts cover such applications as commercial,industrial, and automotives areas.

We are looking forward to setting up business relationship with you and hope to provide you with the best service and solution. Let us make a better world for our industry!



## Contact us

Tel: +86-755-8981 8866 Fax: +86-755-8427 6832

Email & Skype: info@chipsmall.com Web: www.chipsmall.com

Address: A1208, Overseas Decoration Building, #122 Zhenhua RD., Futian, Shenzhen, China





**Rev OI to Rev A Changes:**

1. Not documented.

**How to convert Rev OI to Rev A:**

1. Not possible.

**Rev A to Rev B Changes:**

1. This update was to change TED paperwork to latest standards.
2. No PCB or schematic changes.
3. REV, ASY, OPT, TOP pages added.
4. The BOM for the board, minus sensor, moved to -001 (from -000).  
This was done to fit into the "no -000 assembly" method of multiple build option demo boards.

**How to convert Rev A to Rev B:**

1. No changes necessary.

**Rev B to Rev C Changes:**

1. Assembly Instructions fixed:  
Step 5 had RJ installed as 0.125" and 0.25" in error.  
Changed to be 0.125" installation height.
2. No other changes.

**How to convert Rev B to Rev C:**

1. No changes necessary.

1. RoHS Compliance Required?

**Yes.**

**All components and assembly practices must be RoHS Compliant.**

**Certificates of RoHS compliance must be sent to Allegro for record keeping.**

2. Other TED Packs and/or outside Specifications required for build:  
none required.

3. Are there optional ways to build this TED pack?

Yes.

Please read 85-0322-000-OPT for build options.

4. Pages with the descriptor "-ASY" are expected to be followed by the assembly person / assembly house. These are the Construction Notes / Assembly Notes pages, and are used to convey building instructions.

5. The notes on the -TST pages are expected to be followed by Allegro; product shall not be sold to customers until the steps on the -TST pages are completed. These are test and verification steps, and are used to test assembly(s) prior to usage and/or selling. They are not "calibration" procedures as used on production equipment.

6. All photos provided are for reference only; slight variations may result from component second sourcing or later design changes. Photos are intended to convey roughly what completed assembly should look like.

7. As multiple boards exist under this TED pack number (85-0322), there is no -000 assembly.

8. All boards use the -000-ASY Assembly Instructions.

There are several different assemblies listed under this TED pack.  
Build according to Request Number / Option Number / Description / TBD,  
as explained below:

#	Request:	Build (1) each of these:	Description:
1	ACS712ELC-05B-T	85-0322-010	ACS712ELC-05B-T
	85-0322-010	85-0322-010	ACS712ELC-05B-T
2	ACS712ELC-20A-T	85-0322-011	ACS712ELC-20A-T
	85-0322-011	85-0322-011	ACS712ELC-20A-T
3	ACS712ELC-30A-T	85-0322-012	ACS712ELC-30A-T
	85-0322-012	85-0322-012	ACS712ELC-30A-T
4	ACS713ELC-20A-T	85-0322-013	ACS713ELC-20A-T
	85-0322-013	85-0322-013	ACS713ELC-20A-T
5	ACS713ELC-30A-T	85-0322-014	ACS713ELC-30A-T
	85-0322-014	85-0322-014	ACS713ELC-30A-T

All boards must be labeled after construction (see -000-ASY)

1. These boards do not require testing prior to shipping to customers.

Originator: Shawn Upton

1. All 85-0322 assemblies require a sticker to be applied post-construction. This sticker shall be applied by whomever constructs the boards. This sticker shall be as such:

#		Allegro Part:	Label
1	85-0322-010	ACS712ELC-05B-T	ASEK712ELC-05B-T
2	85-0322-011	ACS712ELC-20A-T	ASEK712ELC-20A-T
3	85-0322-012	ACS712ELC-30A-T	ASEK712ELC-30A-T
4	85-0322-013	ACS713ELC-20A-T	ASEK713ELC-20A-T
5	85-0322-014	ACS713ELC-30A-T	ASEK713ELC-30A-T

2. This sticker may be applied onto the top of the board, if it can be. If the sticker is topside, it shall be located between U1 and the silkscreen text "Current Sensor". This is if it will fit, without overlaying any silkscreen text or solderpads. If the sticker is larger than that area, the sticker shall be located on the backside of the PCB.
3. Any sticker applied by the assembly house (not of the type above) shall be installed on the backside of the pcb. [This may be a tracking number, or the assembly house P/N.] The label shall not cover any holes used for soldering.
4. The Allegro sensor may be installed at any time. That is, all the parts required to build an 85-0322-010 (for example) may be installed at the same time.
5. RJ: 22g jumper.  
Use 22g buss wire, 0.5 inch body, with 0.25 inch leads bent 90 degree. Install 0.125 inch above PCB (not critical).  
Solder and trim.  
This component will be used for scope ground clips.

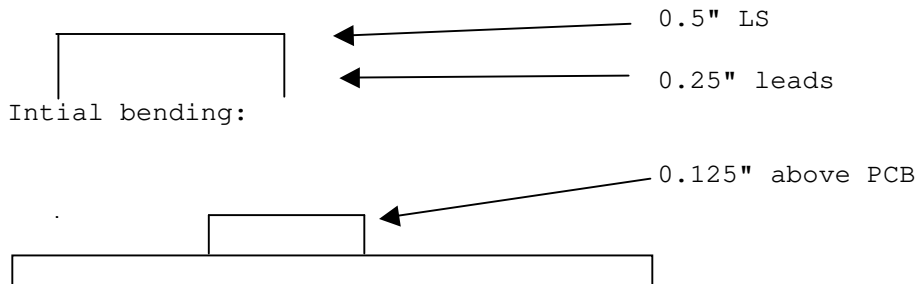

6. It is recommended that the SMT parts be installed first, then thro-hole, then banana jacks and standoffs, lastly the sticker(s). Any order of operations may be performed, however.

**All components and assembly practices must be RoHS Compliant  
Certificates of RoHS compliance must be sent to Allegro for record keeping**

To Install RJ: use buss wire, approx 22-24g. Bend a 1 inch length to 0.5 inch lead spacing,  
just like as if forming leads for a conventional resistor.  
Install approximately 0.25 inch above the PCB.  
This jumper is scope ground clips and must have ample space under it!



A

A

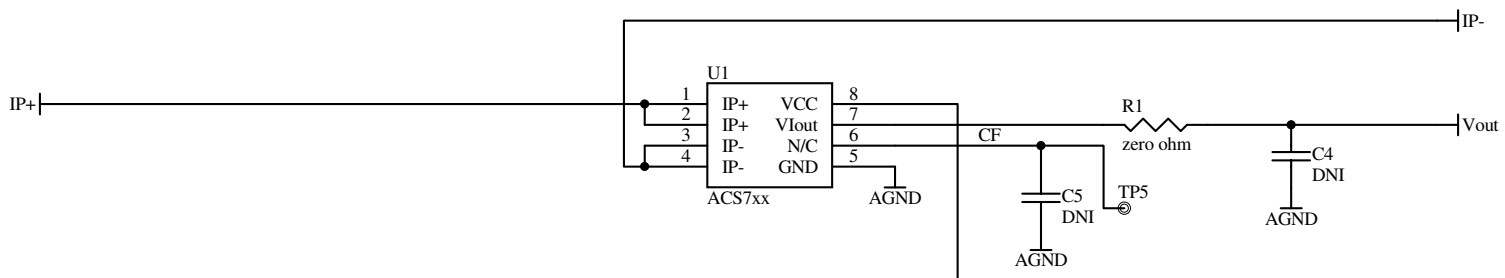

B

B

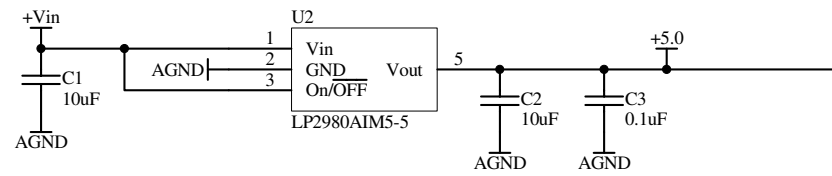

C

C

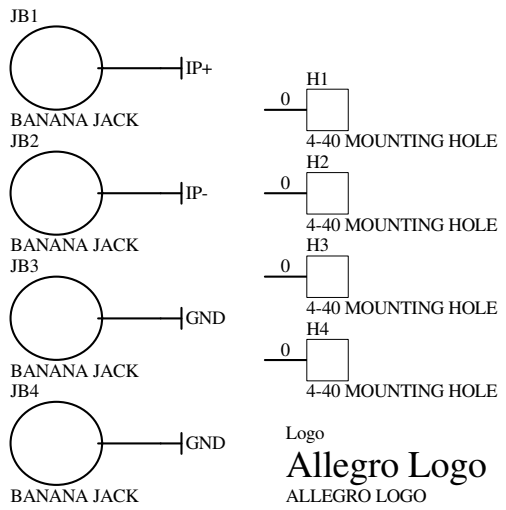
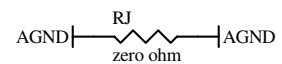
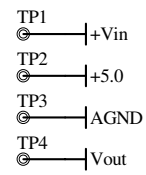
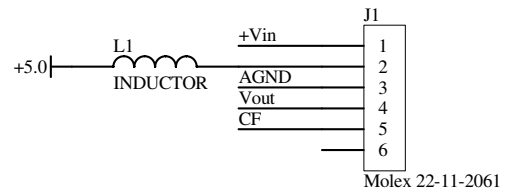

TP1 - TP4: Testpoints for 0.063 hole: Keystone Electronics 5005 or equivalent  
 JB1 - JB4: use Johnson Components 111-2223-001 Banana jack  
 C1, C2: 1206 16V 10uF: Panasonic ECJ-HVB1C106M  
 C3: 0603 16V 0.1uF: Panasonic ECJ-1VB1C104K  
 L1: 0603 Murata BLM18BB471SN1D  
 R1: 0603 zero ohm: Panasonic ERJ-3GEY0R00V  
 RJ: Use buss wire, 0.5inch long and 0.25inch above PCB

RoHS/Pb-free Label

Title <b>ACS7xx Demo Board</b>			
Size: A	Number: 85-0322-000-SCH	Revision: 2	Allegro MicroSystems, Inc 955 Perimeter Rd Manchester NH 03103
Date: 9/21/2006	Time: 2:29:13 PM	Sheet 1 of 1	
File: C:\Documents and Settings\supton\My Documents\DXP\85-0322\85-0322 Rev 2.SchDoc			



D

D

ACS7xx Demo Board  
85-0322-000-BD1

PCB Outline  
Page 1 of 1  
FR4, 0.062, 2 Layers  
4oz Finished Copper top/bottom  
No Gold Plating  
Top/bottom side silkscreen  
Top/bottom soldermask

Rev 3  
9/21/2006

SCALE: 1.48

9/21/2006

Min trace = 10mil, min trace spacing = 10mils, min hole size 15mil

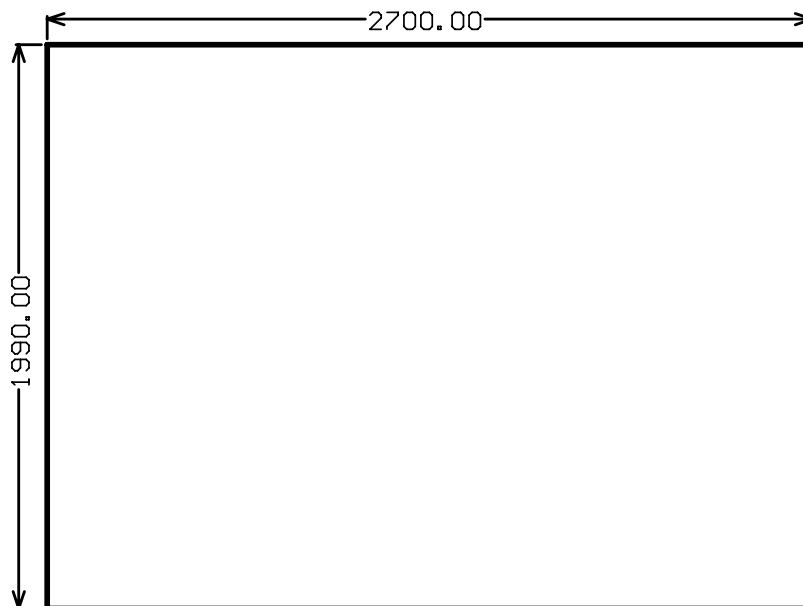

ACS7xx Demo Board  
85-0322-000-SS1

Silkscreen Component Side  
Page 1 of 1  
FR4, 0.062, 2 Layers  
4oz Finished Copper top/bottom  
No Gold Plating  
Top/bottom side silkscreen  
Top/bottom soldermask

Rev 3  
9/21/2006

SCALE: 1.48  
9/21/2006

Min trace = 10mil, min trace spacing = 10mils, min hole size 15mil

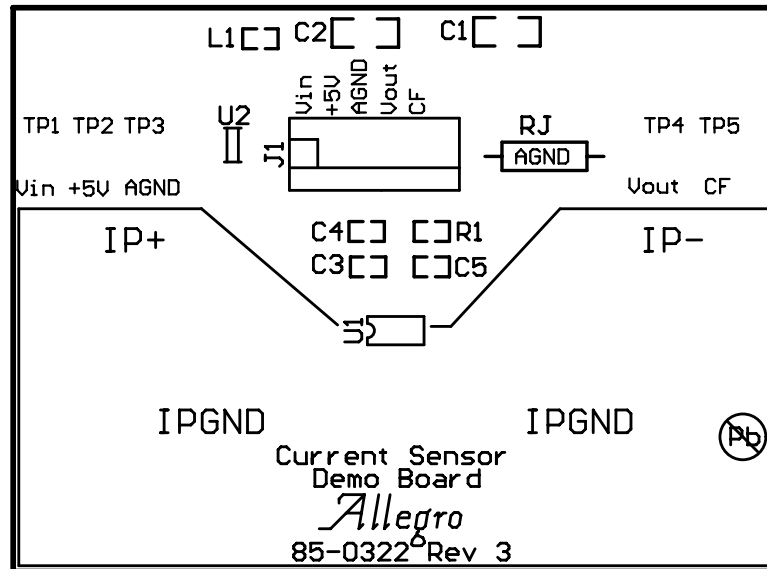

ACS7xx Demo Board  
85-0322-000-SM1

Top Soldermask  
Page 1 of 1  
FR4, 0.062, 2 Layers  
4oz Finished Copper top/bottom  
No Gold Plating  
Top/bottom side silkscreen  
Top/bottom soldermask

Rev 3  
9/21/2006

SCALE: 1.48

9/21/2006

Min trace = 10mil, min trace spacing = 10mils, min hole size 15mil

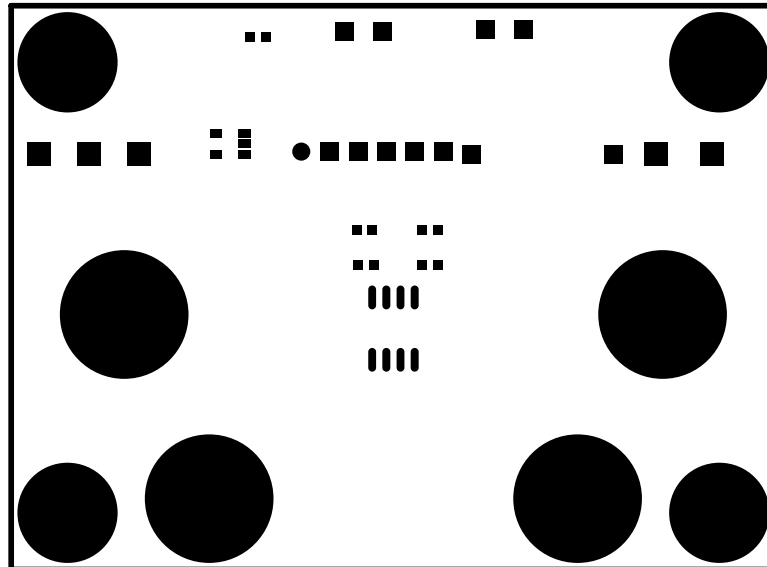

ACS7xx Demo Board  
85-0322-000-SM2

Bottom Soldermask  
Page 1 of 1  
FR4, 0.062, 2 Layers  
4oz Finished Copper top/bottom  
No Gold Plating  
Top/bottom side silkscreen  
Top/bottom soldermask

Rev 3  
9/21/2006

SCALE: 1.48

9/21/2006

Min trace = 10mil, min trace spacing = 10mils, min hole size 15mil

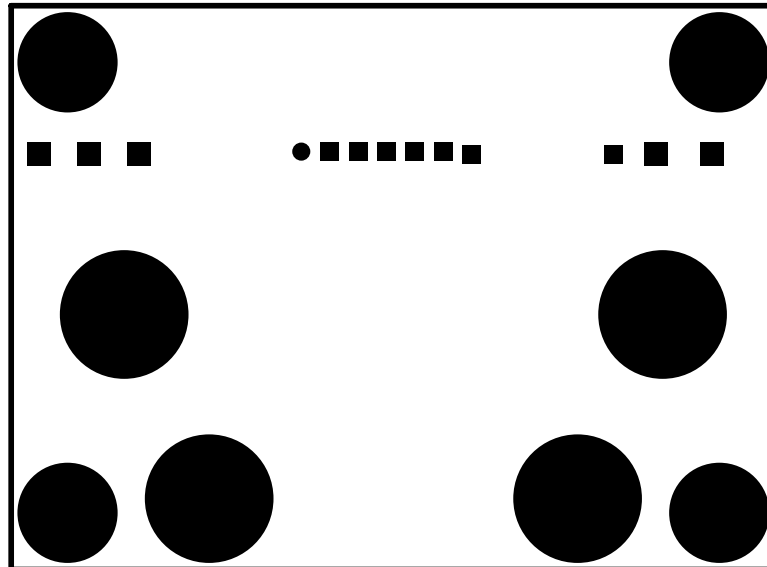

ACS7xx Demo Board  
85-0322-000-CU1

Copper Component Side  
Page 1 of 1  
FR4, 0.062, 2 Layers  
4oz Finished Copper top/bottom  
No Gold Plating  
Top/bottom side silkscreen  
Top/bottom soldermask

Rev 3  
9/21/2006

SCALE: 1.48

9/21/2006

Min trace = 10mil, min trace spacing = 10mils, min hole size 15mil

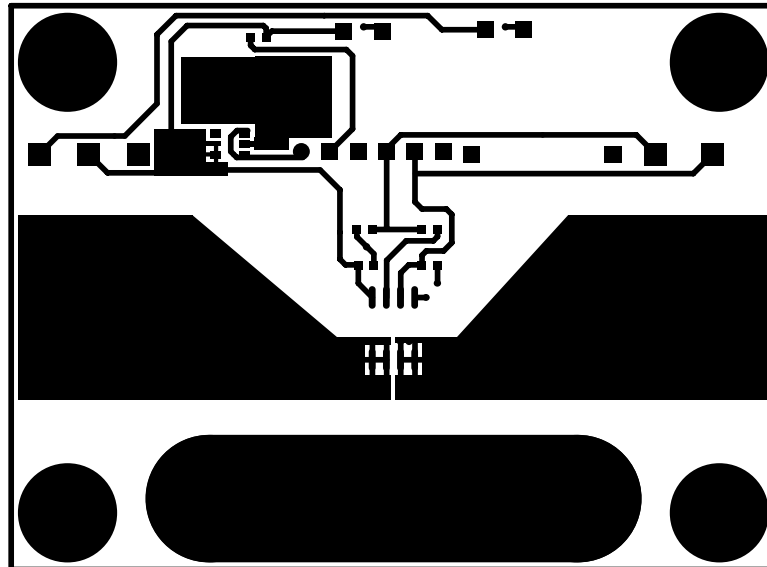

ACS7xx Demo Board  
85-0322-000-CU2

Copper Solder Side  
Page 1 of 1  
FR4, 0.062, 2 Layers  
4oz Finished Copper top/bottom  
No Gold Plating  
Top/bottom side silkscreen  
Top/bottom soldermask

Rev 3  
9/21/2006

SCALE: 1.48

9/21/2006

Min trace = 10mil, min trace spacing = 10mils, min hole size 15mil

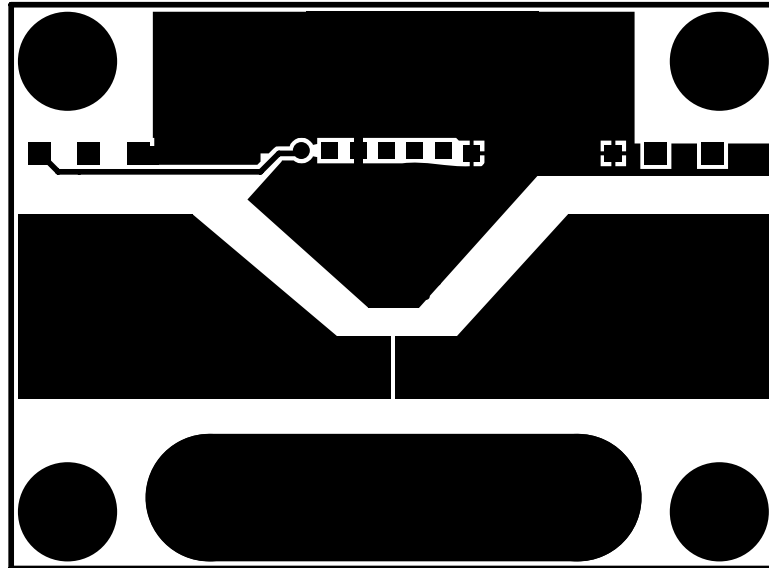

ACS7xx Demo Board  
85-0322-000-GG1

Drill Guide  
Page 1 of 1  
FR4, 0.062, 2 Layers  
4oz Finished Copper top/bottom  
No Gold Plating  
Top/bottom side silkscreen  
Top/bottom soldermask

Rev 3  
9/21/2006

SCALE: 1.48

9/21/2006

Min trace = 10mil, min trace spacing = 10mils, min hole size 15mil

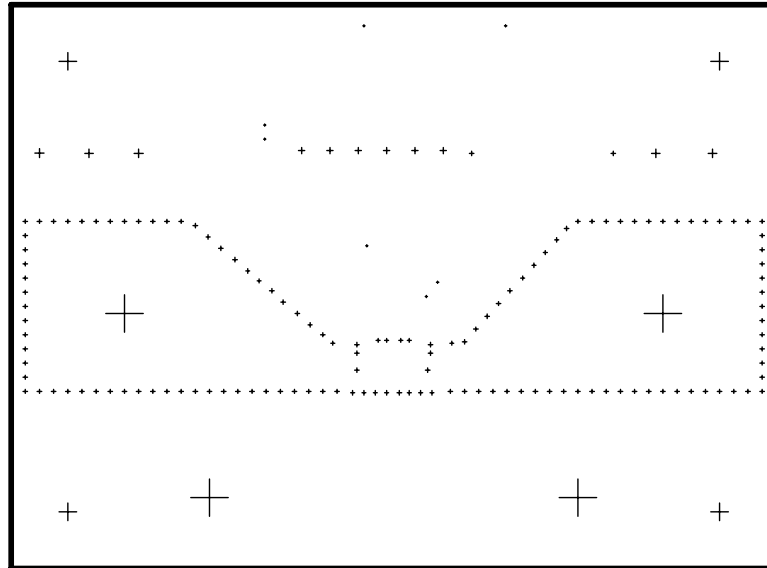



ACS7xx Demo Board  
 85-0322-000- GD1

Drill Drawing  
 Page 1 of 1  
 FR4, 0.062, 2 Layers  
 4oz Finished Copper top/bottom  
 No Gold Plating  
 Top/bottom side silkscreen  
 Top/bottom soldermask

Rev 3  
 9/21/2006

SCALE: 1.48

9/21/2006

Min trace = 10mil, min trace spacing = 10mils, min hole size 15mil

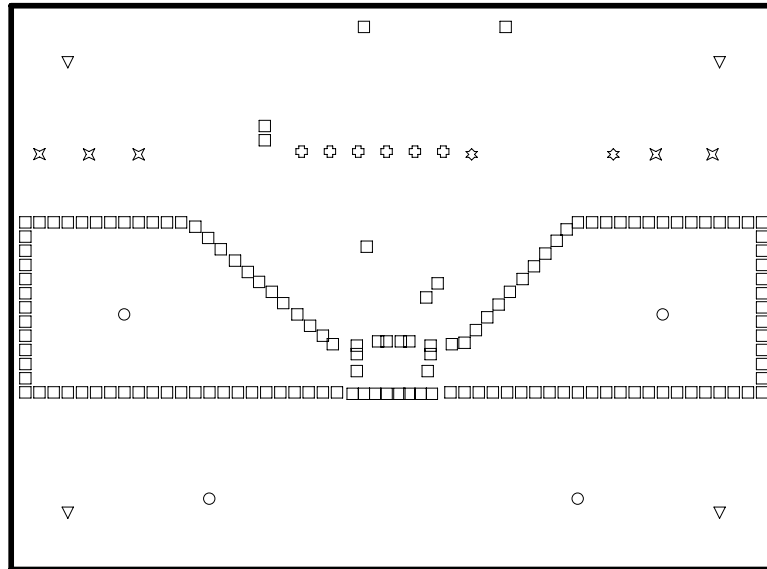

□	142	15mil	0.381mm	PTH
⊗	2	32mil	0.8128mm	PTH
⊕	6	42mil	1.0668mm	PTH
⊗	5	62mil	1.5748mm	PTH
▽	4	125mil	3.175mm	PTH
○	4	266mil	6.7564mm	PTH
	163	Total		

ITEM	QTY	S	Manufacturer	P/N	DESCRIPTION	REF
1	2	6	Panasonic	ECJ-HVB1C106M	capacitor, monolythic, 1206, X5R, 10uF, 16V	C1, C2
2	1	6	Panasonic	ECJ-1VB1C104K	capacitor, monolythic, 0603, X5R, 0.1uF, 16V	C3
3					Do Not Install	C4, C5
4	1	6	Panasonic	ERJ-3GEY0R00V	resistor, metal film, 0603, 5%, zero ohm	R1
5	1	6	Murata	BLM18BB471SN1D	inductor, 0603	L1
6	1	10	National Semi	LP2980AIM5-5.0	IC, voltage regulator, 5V, SOT-23-5	U2
7	4	10	Johnson Components	111-2223-001	connector, banana plug	IP+, IP-, IPGND, IPGND
8	5	10	Keystone Electronics	5005K	testpoint, 0.063 inch diameter, red	TP1 through TP5
9	4				screw, zinc metal plated, 4-40, 0.5 inch, Philips	see construction notes
10	4	6	Keystone Electronics	1450C	standoff, male/male, zinc metal plated, 4-40, 0.5 inch long, hex shaped	see construction notes
11	1	10	Molex	22-11-2062	connector, friction lock header, 6 pin	J1
12	1				buss wire, tinned, 22 or 24 gauge 0.5 inch long. See construction notes	RJ
13	1	10			PCB, as from gerber files marked "85-0322"	
14	1	10	Allegro	Current Sensor	IC, SOIC8, as provided by Allegro	U1

All components and assembly practices must be RoHS Compliant  
 Certificates of RoHS compliance must be sent to Allegro for record keeping

**BOM Explanation**

Item: each distinct component has a "line item" (but may span multiple lines). When questions arise to a component parameter/designation/etc, please refer to line item number first when inquiring.

QTY: the quantity of items to be ordered per finished assembly. Note: higher level documents may call this BOM multiple times

S: BOM Substitution Instructions. See below

Manufacturer: Recommended (or required) Manufacturer for the part(s). Note: multiple manufacturers may be listed per line item.

Note: if no manufacturer part number is given, the the item is considered generic enough that that any manufacturer should work. Ie, 1N4001 in a DO-41

P/N: The manufacturers part number. Note: if multiple manufacturers are listed, this P/N will correspond only to the manufacturer to the immediate left of the P/N

Note: Manufacturer part number may be incomplete; if not enough information is given, see below.

Description: this is a generic description of the part. Package size, part type, minimum/maximum requirements are listed.

Note: this is generic and may not exactly reflect the suggested/required part. For example, "capacitor, 25V" while the manufacturer P/N is actually 50V. The capacitor is required to a minimum of 25V rated (important only if second sourcing)

Ref: This is the list of component designators.

If "see construction notes" is listed, the construction notes must be used to determine component location (not marked on board etc)

Note: surface mount components may have a designator listed but not marked on PCB silkscreen; if so then refer to -CPG (or similar) drawing for location and/or the pick and place file (as found in the gerber files)

If a line item has multiple part numbers, they are not to be interpreted as any order of preference

If a line item has multiple part numbers, and the substitution code is 10, then only use parts as listed.

Mixing is allowed (for example, if 2 manufacturers are listed, and qty is 5, then 2 parts may be from vendor A and 3 parts from vendor B) regardless of code.

**BOM Substitution Notes:**

The third column nomenclature is to be used for second sourcing components as follows:

1. Any substitution allowed, as long as mechanically identical (non-electrical items only) (visually different ok)
2. Any substitution allowed, as long as mechanically similar (non-electrical items only) (visually different ok)
3. Any substitution, as long as mechanically and visually identical (non-electrical items only)
4. Any substitution allowed, as long as mechanically and visually similar (non-electrical items only)
5. Any substitution allowed, as long as mechanically and visually identical and electrically similar
6. Any substitution allowed, as long as mechanically, electrically and visually similar
7. Reserved for future usage.
8. Reserved for future usage
9. Substitution not recommended, but allowed if mechanically, electrically and visually similar. Only substitute if no alternative.
10. No substitution allowed.

**"Identical"** is to be interpreted as "meeting the same specifications" with no deviation from the specifications.

If no manufacturer is given, then do not deviate from stated specifications in the Description field.

If a manufacturer is given, do not deviate from the specifications from the manufacturer--the Description field is for reference only then.

**"Similar"** is to be interpreted as "meeting or exceeding the stated specifications, in regards to electrical and/or mechanical parameters (see Substitution code).

If no manufacturer is given, then do not deviate from stated specifications in the Description field.

If a manufacturer is given, do not deviate from the specifications from the manufacturer--the Description field is for reference only then.

**"Similar"** as applied to visual means different colors may be used, unless otherwise noted. For example, an item with Substitution code 6 can typically be any color.

However, if the description states "red" and the substitution code is 4, 6 or similar, then a red item must be used--but it may be any shade of red.

For example, if a capacitor is to be "identical", it must have the same voltage and tempco etc ratings as stated in the description.

If a capacitor is to be similar, the voltage rating may be higher, the tempco lower, etc.

Unless if the Substitution code is 10, "identical" parts may be sourced from different manufacturers and may have slight differences in appearance.

These subtle differences are ok.

**Substituting for "Similar" parts:**

Capacitors:

-tempco must be same or go down. Alternately, go up in this order: Z5U, X5R, X7R, NP0, C0G

-tolerance must be same or go down

-voltage rating must be same or go up

-unless otherwise stated, capacitance value must be identical

-unless otherwise stated, lead spacing must be same; external dimensions must be the same or smaller

Resistors:

-tempco must same or go down

-tolerance must be same or go down

-unless otherwise stated, resistance value must be identical

Note: when going from 5% to 1%, use nearest value size

-power dissipation must be same or greater

-unless otherwise stated, package size must be the same

-unless otherwise stated, coloring and marking can vary

Diodes and Transistors:

-unless otherwise stated, package size must be the same

IC's, Connectors, and all other parts::

-unless otherwise stated, package size must be the same (DIP16, SOIC-8, etc)

**Manufacturer Part Number Discrepancies**

Every attempt will be made to provide a workable part number. However, prefixes and suffixes can vary over time.

If second sourcing from a different manufacturer, make sure that the requirements as noted under the Description column are met.

In general, if temperature option(s) are not noted, parts specified to work from 0-85C will be sufficient.

If package information is not given, please check the manufacturer datasheet for package type.

**Any and all discrepancies should be reported to Allegro MicroSystems for correction and updates.**

ACS7xx Demo Board  
85-0322-010-BOM  
Originator: Shawn Upton

Bill of Materials  
Page 1 of 1

Rev 3  
5/28/2008

ITEM	QTY	S	Manufacturer	P/N	DESCRIPTION	REF
1	1	10	Allegro	85-0322-001	board	
2	1	10	Allegro	ACS712ELC-05B-T	IC, SOIC8, current sensor	U1

All components and assembly practices must be RoHS Compliant  
Certificates of RoHS compliance must be sent to Allegro for record keeping

ACS7xx Demo Board  
85-0322-011-BOM  
Originator: Shawn Upton

Bill of Materials  
Page 1 of 1

Rev 3  
5/28/2008

ITEM	QTY	S	Manufacturer	P/N	DESCRIPTION	REF
1	1	10	Allegro	85-0322-001	board	
2	1	10	Allegro	ACS712ELC-20A-T	IC, SOIC8, current sensor	U1

All components and assembly practices must be RoHS Compliant  
Certificates of RoHS compliance must be sent to Allegro for record keeping

ACS7xx Demo Board  
85-0322-012-BOM  
Originator: Shawn Upton

Bill of Materials  
Page 1 of 1

Rev 3  
5/28/2008

ITEM	QTY	S	Manufacturer	P/N	DESCRIPTION	REF
1	1	10	Allegro	85-0322-001	board	
2	1	10	Allegro	ACS712ELC-30A-T	IC, SOIC8, current sensor	U1

All components and assembly practices must be RoHS Compliant  
Certificates of RoHS compliance must be sent to Allegro for record keeping

ACS7xx Demo Board  
85-0322-013-BOM  
Originator: Shawn Upton

Bill of Materials  
Page 1 of 1

Rev 3  
5/28/2008

ITEM	QTY	S	Manufacturer	P/N	DESCRIPTION	REF
1	1	10	Allegro	85-0322-001	board	
2	1	10	Allegro	ACS713ELC-20A-T	IC, SOIC8, current sensor	U1

All components and assembly practices must be RoHS Compliant  
Certificates of RoHS compliance must be sent to Allegro for record keeping



ACS7xx Demo Board  
85-0322-014-BOM  
Originator: Shawn Upton

Bill of Materials  
Page 1 of 1

Rev 3  
5/28/2008

ITEM	QTY	S	Manufacturer	P/N	DESCRIPTION	REF
1	1	10	Allegro	85-0322-001	board	
2	1	10	Allegro	ACS713ELC-30A-T	IC, SOIC8, current sensor	U1

All components and assembly practices must be RoHS Compliant  
Certificates of RoHS compliance must be sent to Allegro for record keeping