



Chipsmall Limited consists of a professional team with an average of over 10 year of expertise in the distribution of electronic components. Based in Hongkong, we have already established firm and mutual-benefit business relationships with customers from,Europe,America and south Asia,supplying obsolete and hard-to-find components to meet their specific needs.

With the principle of “Quality Parts,Customers Priority,Honest Operation,and Considerate Service”,our business mainly focus on the distribution of electronic components. Line cards we deal with include Microchip,ALPS,ROHM,Xilinx,Pulse,ON,Everlight and Freescale. Main products comprise IC,Modules,Potentiometer,IC Socket,Relay,Connector.Our parts cover such applications as commercial,industrial, and automotives areas.

We are looking forward to setting up business relationship with you and hope to provide you with the best service and solution. Let us make a better world for our industry!



Contact us

Tel: +86-755-8981 8866 Fax: +86-755-8427 6832

Email & Skype: info@chipsmall.com Web: www.chipsmall.com

Address: A1208, Overseas Decoration Building, #122 Zhenhua RD., Futian, Shenzhen, China



Configurable High Performance SMD TCXO/VCTCXO

ASGTX



ESD Sensitive



RoHS/RoHS II Compliant

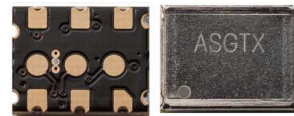

9.0 x 7.0 x 2.24 mm

OVERVIEW:

ASGTX temperature compensated Crystal Oscillators are designed to accommodate a broad breadth of Precision TCXO requirements, without NRE and extended lead-times. This oscillator series is designed and manufactured by Abracon Corporation and is available to order from 1pc to high volume production quantities.

- **1-5 day quick-turn availability of a TCXO/VCTCXO with LVCMOS output, Any frequency between 10MHz & 250MHz**

For example, if a reference oscillator requirement calls out 49.7521MHz; ± 1.00 ppm TCXO/VCTCXO with LVCMOS output, ASGTX can be configured and shipped within 1-5 days and in most cases, same day if order is received before noon. Customers with low-to-mid annual volume requirements find it difficult to procure custom frequency TCXO/VCTCXO's without costly NRE charges and/or long lead-times (≥ 12 weeks).

- **1-5 day quick turn availability of a TCXO/VCTCXO requiring LVDS or LVPECL Differential output, Any frequency between 10MHz to 1.50GHz**

ASGTX is available with either LVDS or LVPECL output, from 10MHz to 1.50GHz; at any desired frequency, such as 149.875MHz, 1.00GHz, 1.5GHz, etc. with as tight as ± 1.00 ppm stability over temperature. No other solution in the marketplace currently offers such capability, especially in a small form-factor of 9.0x7.0x2.24 mm.

ASGTX is suitable for a wide variety of precision timing applications where TCXO/VCTCXO's are typically employed. In addition, for high frequency LO requirements, traditionally customers have relied on SAW based oscillators. Such devices are only available at a few fixed frequencies, such as 915MHz, 1.0GHz, etc. They are typically in 9x14mm or bigger packages and vary as much as ± 100 ppm over temperature.

Although ASGTX series will be slightly less favorable in phase noise performance compared to SAW based oscillators, it offers the following key advantages:

- o ± 1.00 ppm stability over -30°C to $+70^{\circ}\text{C}$ & ± 2.00 ppm stability over -40°C to $+85^{\circ}\text{C}$
- o **Any carrier frequency** between 10MHz & 1.50GHz
- o LVCMOS Output (10MHz to 250MHz) **or** LVDS / LVPECL Output (10MHz to 1.50GHz)
- o Small form-factor of 9.0x7.0x2.24 mm
- o No NRE or lead-time

FEATURES:

- 10MHz to 1.50GHz, any Carrier Frequency in differential mode (LVDS or LVPECL)
- 10MHz to 250MHz, any Carrier Frequency in LVCMOS mode
- -40°C to $+85^{\circ}\text{C}$ operating temperature range
- ± 1.0 ppm stability over -30°C to $+70^{\circ}\text{C}$ and ± 2.0 ppm stability over -40°C to $+85^{\circ}\text{C}$
- Minimum guaranteed pull ability of ± 10 ppm in VCTCXO mode
- Good Phase Noise, excellent Harmonics and Spurious content
- Guaranteed rms jitter of 1.80ps maximum @ 1.50GHz carrier (LVDS mode)
- Immediate availability, 5-day maximum lead-time for small quantities

APPLICATIONS:

- 40G & 100G Ethernet
- WiMax,
- LTE, BTS
- CATV, LAN, LMDS
- Point-to-Point communication networks

ABRACON IS
ISO9001:2008
CERTIFIED



2 Faraday, Suit#B, Irvine, California 92618 **Revised: 10.16.14**

tel:949-546-8000 | fax:949-546-8001

Visit www.abracon.com for Terms & Conditions of Sale

Configurable High Performance SMD TCXO/VCTCXO

ASGTX

 RoHS/RoHS II Compliant

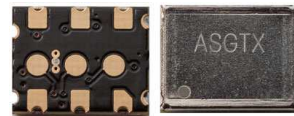

9.0 x 7.0 x 2.24 mm

KEY ELECTRICAL SPECIFICATIONS:

Parameters		Minimum	Typical	Maximum	Units	Notes
Frequency:	LVC MOS	10		250	MHz	
	LVDS	10		1500		
	LVPECL	10		1500		
Operating Temperature:		-40		+85	°C	
Storage Temperature:		-40		+85	°C	
Frequency Stability:						
Initial Set Tolerance		-1.50	≤ ±1.00	+1.50	ppm	1 hour after reflow
Stability over operating temperature*	-30°C to +70°C	-1.00		+1.00	ppm	Option "1"
	-40°C to +85°C **	-2.00		+2.00		Option "2"
Aging @ 25°C after one year		-1.00		+1.00	ppm	
Supply Voltage (V _{dd}):		3.135	3.300	3.465	V	
Startup Time:				3	ms	
Control Voltage***:		0		V _{dd}	V	In VCTCXO Mode
Frequency Pull:		±10			ppm	
Phase jitter RMS [t _{jitter} (σ)] **** (12kHz to 20MHz)			<1.00	1.80	ps	Frequency dependent

- Notes**
- * *Relative to measured frequency post reflow*
 - ** *Please contact Abracon for ±1.00 ppm frequency stability over -40°C to +85°C*
 - *** *Center Control Voltage value is either 1.28V ±0.20V or, 1.55V ±0.20V for the device to be with-in ±1.50 ppm of final frequency, 1-hour post reflow*
 - **** *1.8ps max is guaranteed for LVC MOS and LVDS output modes. For LVPECL mode at carrier frequency greater than 1.289GHz, the maximum RMS jitter is 3.0ps*

Key Electrical Specifications – LVC MOS

Parameters		Minimum	Typical	Maximum	Units	Notes
Supply Current (I _{dd}):				45	mA	Frequency dependent
Output Load:				15	pF	
Output Logic Level:	V _{OH}	0.9*V _{dd}			V	
	V _{OL}			0.1*V _{dd}	V	
Rise Time (Tr):				1000	ps	
Fall Time (Tf):				1000	ps	
Duty Cycle:		45		55	%	@1/2V _{dd}

Configurable High Performance SMD TCXO/VCTCXO

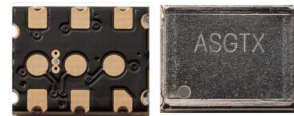

9.0 x 7.0 x 2.24 mm

ASGTX

RoHS/RoHS II Compliant

Key Electrical Specifications – LVPECL

Parameters	Minimum	Typical	Maximum	Units	Notes
Supply Current (I_{dd})			60	mA	With typical LVPECL output termination
Output Logic Level	V_{OH}	$V_{dd}-1.03$		$V_{dd}-0.60$	V
	V_{OL}	$V_{dd}-1.85$		$V_{dd}-1.60$	V
Rise Time (T_r):			350	ps	
Fall Time (T_f):			350	ps	
Differential Duty Cycle:	45		55	%	$DODC_{LVPECL}$

Key Electrical Specifications – LVDS

Parameters	Minimum	Typical	Maximum	Units	Notes
Supply Current (I_{dd})			40	mA	With typical LVDS output termination
Differential Output Voltage (V_{OD})	175	350		mV	
V_{OD} Magnitude Change (ΔV_{OD})			50	mV	
Offset Voltage (V_{OS})		1.25		V	
V_{OS} Magnitude Change (ΔV_{OS})			50	mV	
Rise Time (T_r):			350	ps	
Fall Time (T_f):			450	ps	
Differential Duty Cycle:	45		55	%	ODC_{LVDS}

➤ OPTIONS & PART IDENTIFICATION:

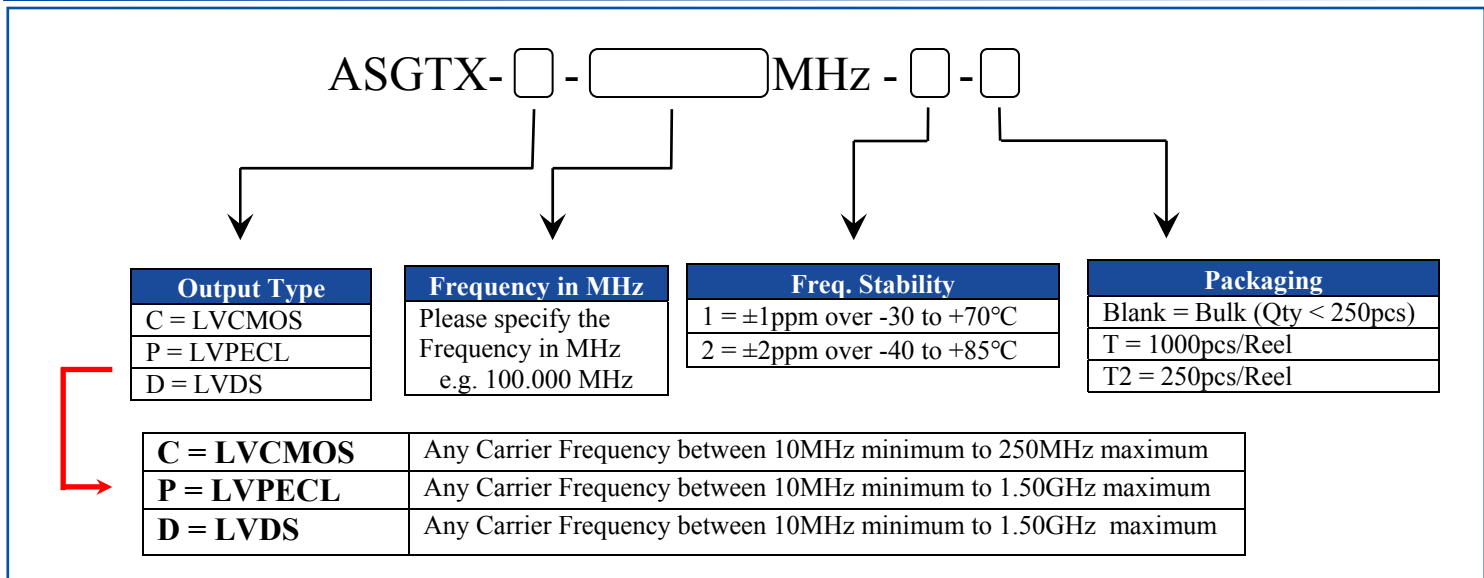

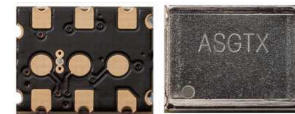

9.0 x 7.0 x 2.24 mm

ASGTX

RoHS/RoHS II Compliant

TYPICAL PHASE NOISE & JITTER CHARACTERISTICS

With LVCMOS Output; 10MHz Carrier

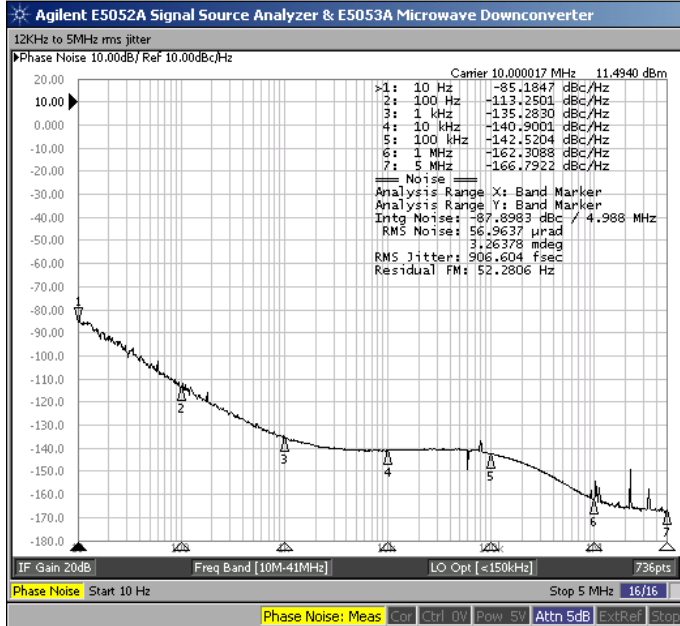

With LVDS Output; 10MHz Carrier

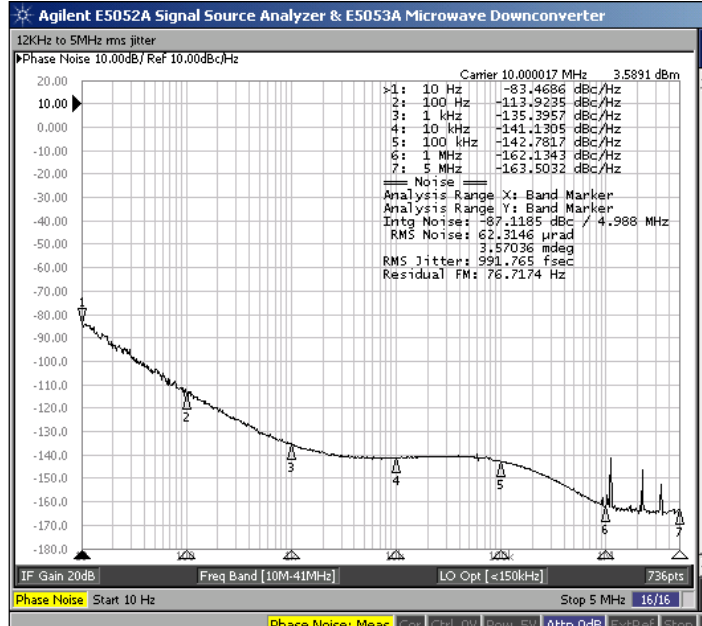

With LVCMOS Output; 25MHz Carrier

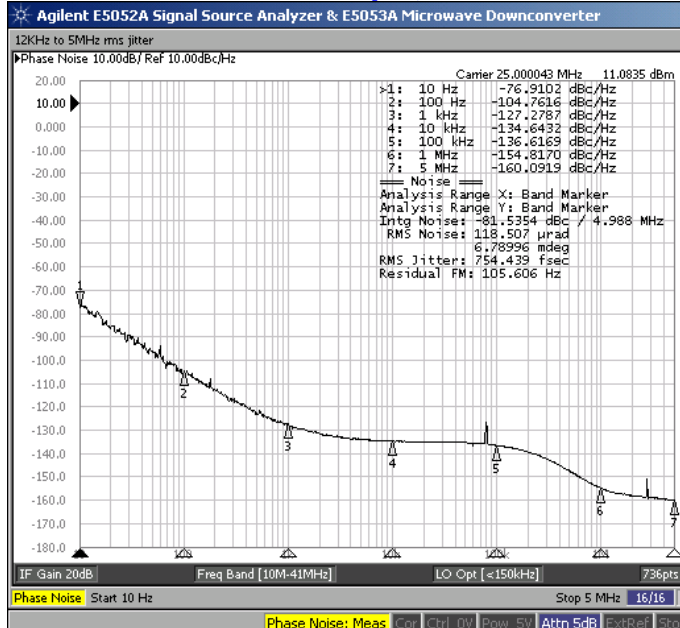

With LVDS Output; 25MHz Carrier

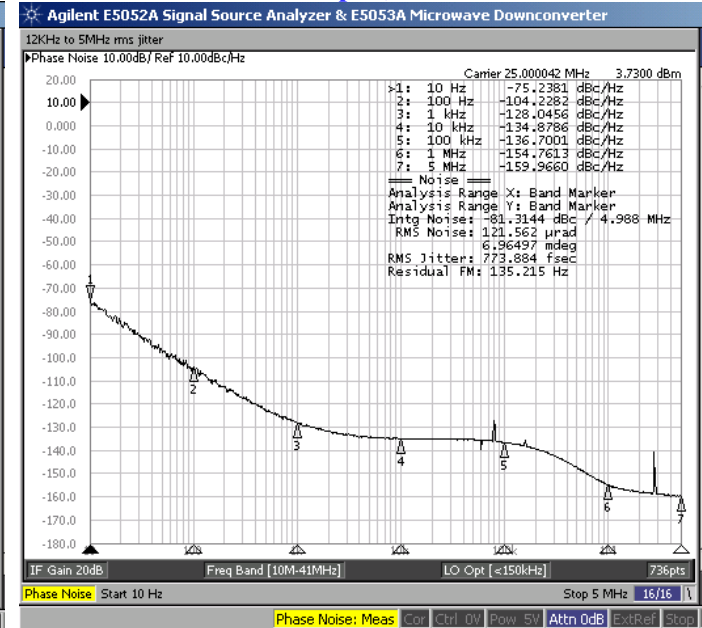

Configurable High Performance SMD TCXO/VCTCXO

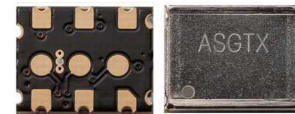

9.0 x 7.0 x 2.24 mm

ASGTX

RoHS/RoHS II Compliant

TYPICAL PHASE NOISE & JITTER CHARACTERISTICS

With LVC MOS Output; 50MHz Carrier

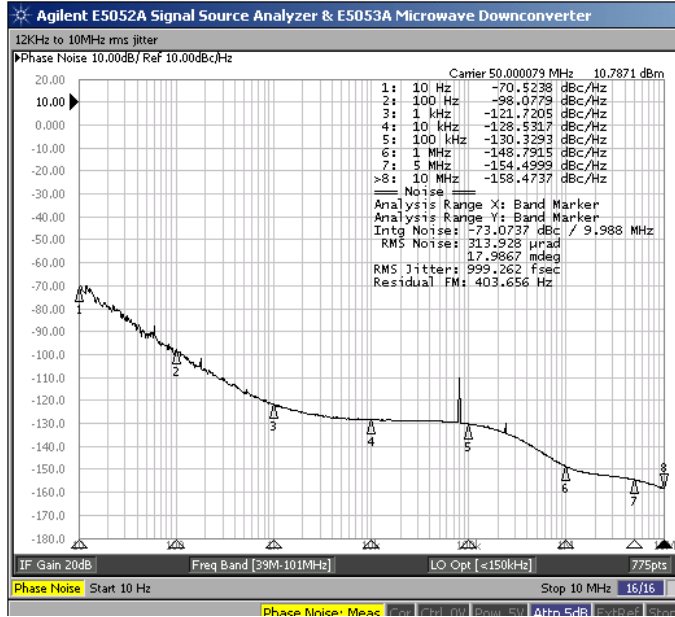

With LVDS Output; 50MHz Carrier

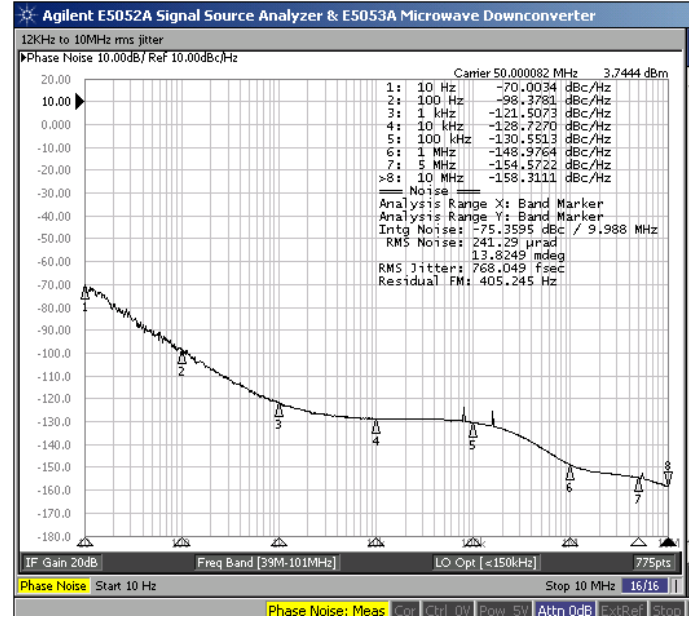

With LVC MOS Output; 120MHz Carrier

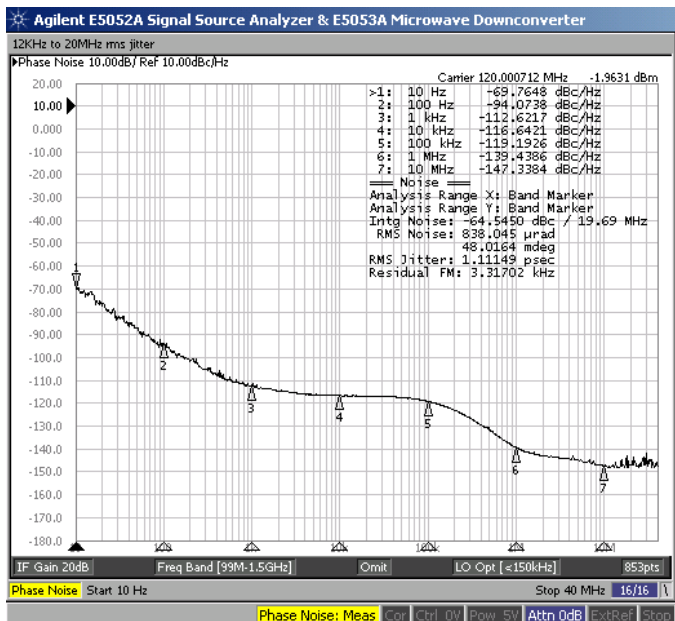

With LVPECL Output; 500MHz Carrier

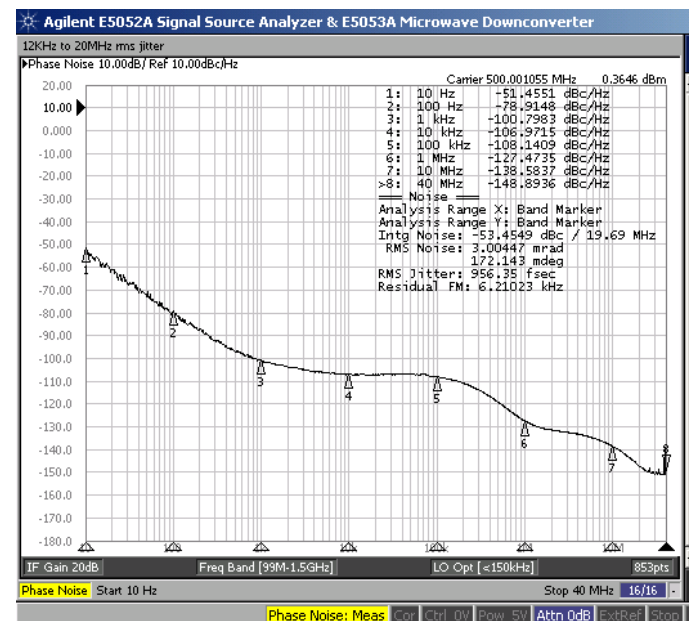

ABRACON IS
ISO9001:2008
CERTIFIED



2 Faraday, Suit#B, Irvine, California 92618 Revised: 10.16.14
tel:949-546-8000 | fax:949-546-8001
Visit www.abracon.com for Terms & Conditions of Sale

Configurable High Performance SMD TCXO/VCTCXO

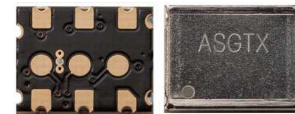

9.0 x 7.0 x 2.24 mm

ASGTX

RoHS/RoHS II Compliant

TYPICAL PHASE NOISE & JITTER CHARACTERISTICS

With LVDS Output; 1.00GHz Carrier

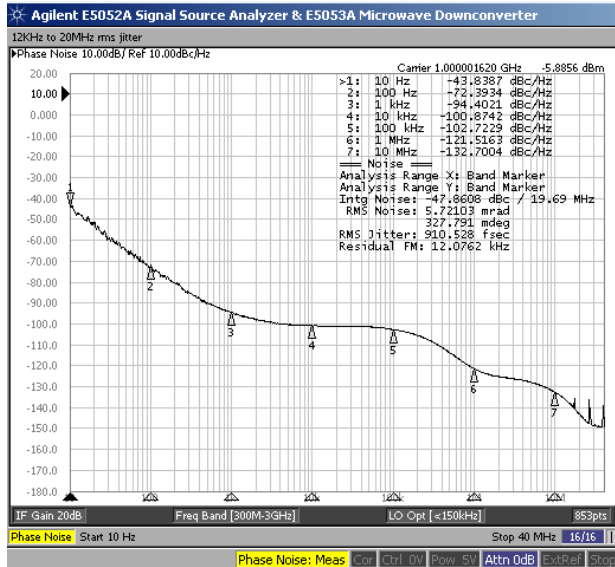

With LVDS Output; 1.2890625GHz Carrier

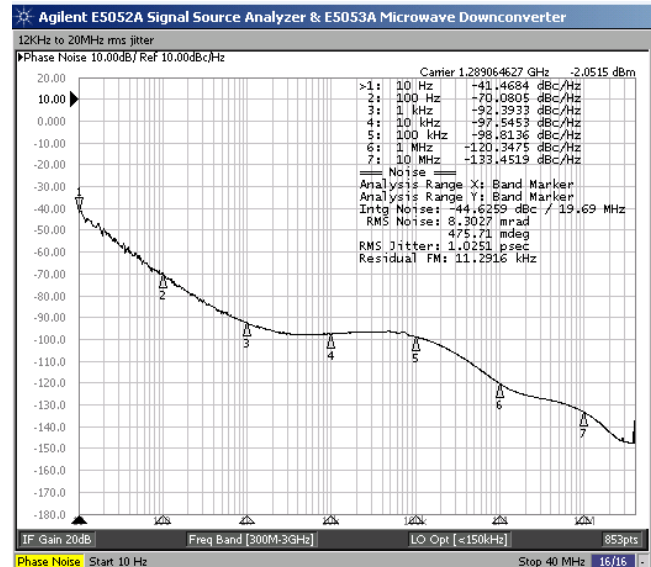

With LVDS Output; 1.50GHz Carrier

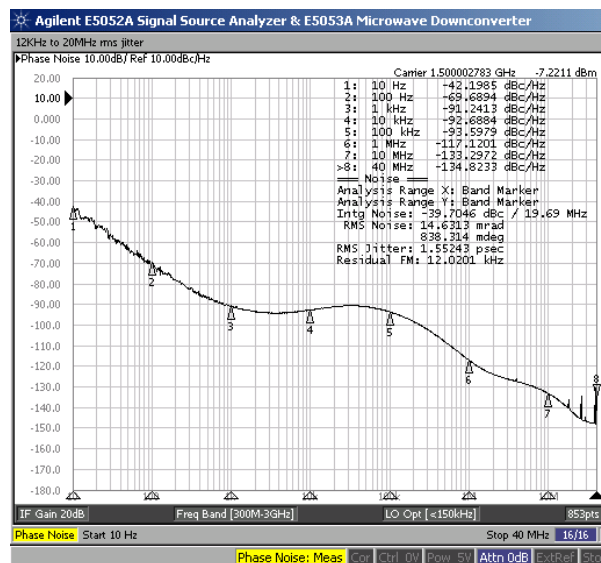

Carrier	RF Output	rms Phase Jitter	Integration Bandwidth
10.00MHz	LVDS	992 fs	12kHz to 5MHz
25.00MHz	LVDS	774 fs	12kHz to 5MHz
50.00MHz	LVDS	768 fs	12kHz to 10MHz
120.00MHz	LVC MOS	1.1 ps	12kHz to 20MHz
500.00MHz	LVPECL	956 fs	12kHz to 20MHz
1.00GHz	LVDS	911 fs	12kHz to 20MHz
1.2890625GHz	LVDS	1.03 ps	12kHz to 20MHz
1.50GHz	LVDS	1.55 ps	12kHz to 20MHz

ABRACON IS
ISO9001:2008
CERTIFIED



2 Faraday, Suit#B, Irvine, California 92618 Revised: 10.16.14
tel:949-546-8000 | fax:949-546-8001
Visit www.abracon.com for Terms & Conditions of Sale

Configurable High Performance SMD TCXO/VCTCXO

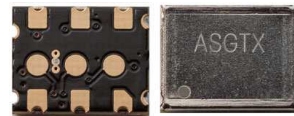

9.0 x 7.0 x 2.24 mm

ASGTX

RoHS/RoHS II Compliant

FREQUENCY STABILITY VS. TEMPERATURE

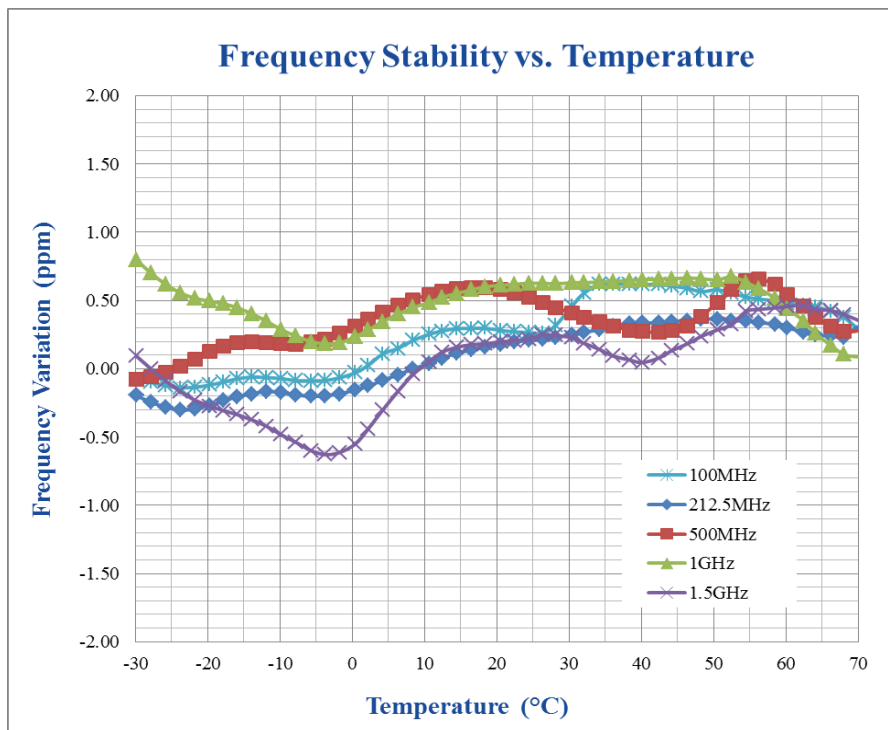

FREQUENCY PULL VS. CONTROL VOLTAGE (VCTCXO MODE)

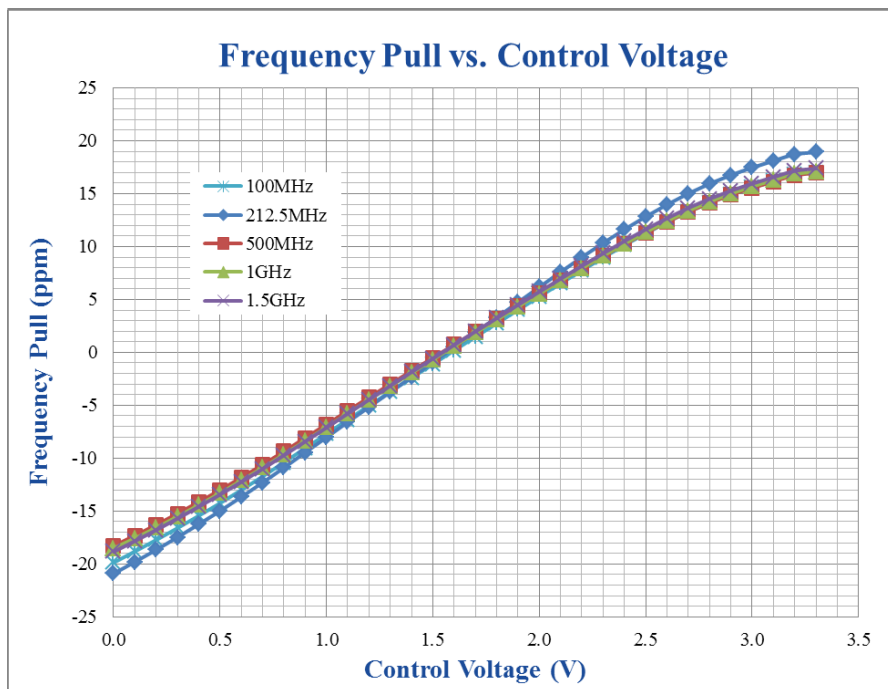

Configurable High Performance SMD TCXO/VCTCXO

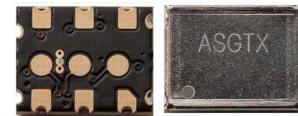

9.0 x 7.0 x 2.24 mm

ASGTX

RoHS/RoHS II Compliant

OUTLINE DIMENSION:

LVC MOS output

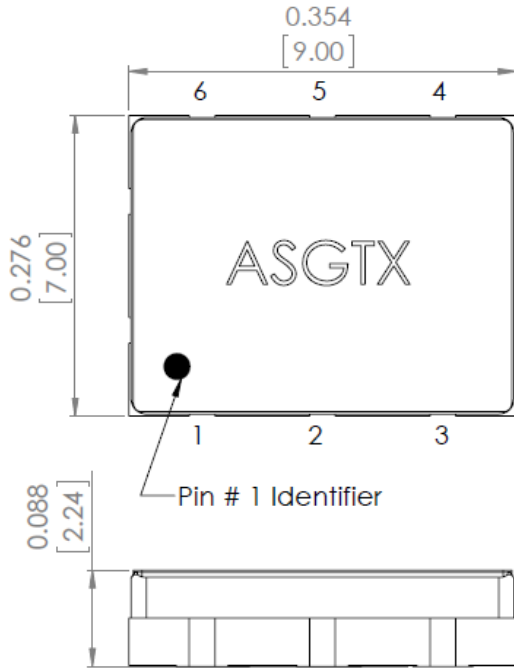

Pin #	Pin Description	
	TCXO	VCTCXO
1	N/C ⁽¹⁾	
2	By-Pass ⁽²⁾	Vc ⁽³⁾
3	GND	
4	RF Output	
5	N/C ⁽¹⁾	
6	Vdd	

N/C ⁽¹⁾ = Please leave these pins electrically floating on the end-PCB

By-Pass ⁽²⁾ = In TCXO configuration, it is recommended that a 1,000pF COG by-pass capacitor is connected between Pin#2 and GND

Vc ⁽³⁾ = Please connect external voltage to pull the oscillator frequency

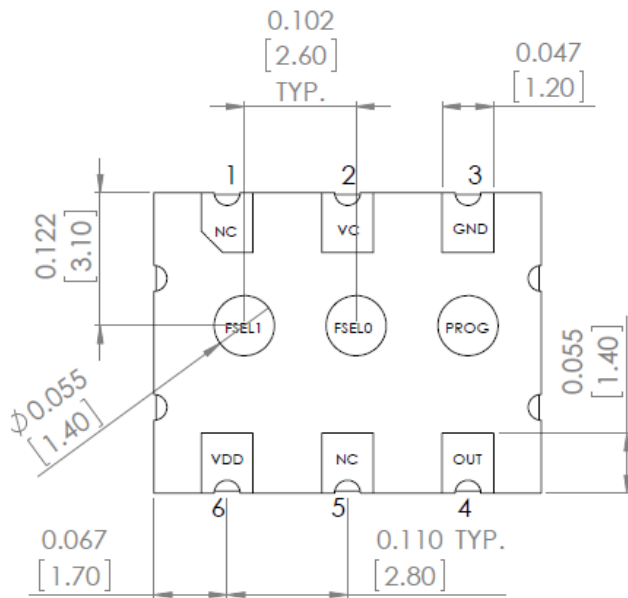

Recommended Land Pattern

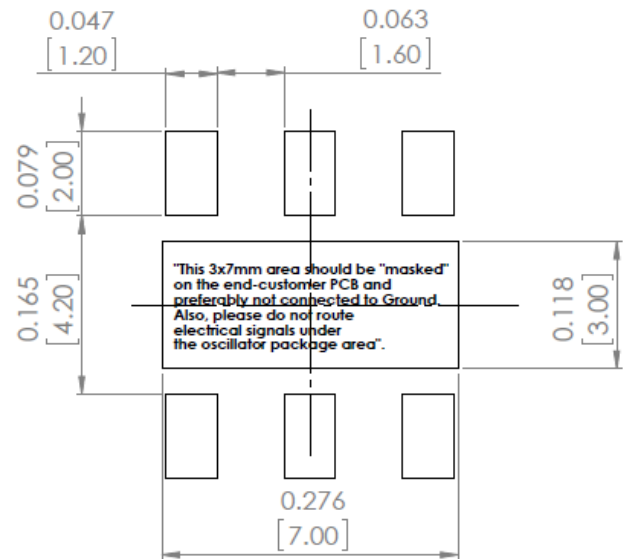

Dimensions: inches [mm]

Configurable High Performance SMD TCXO/VCTCXO

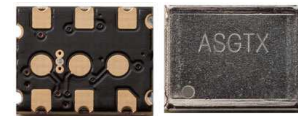

9.0 x 7.0 x 2.24 mm

ASGTX

RoHS/RoHS II Compliant

REFLOW PROFILE:

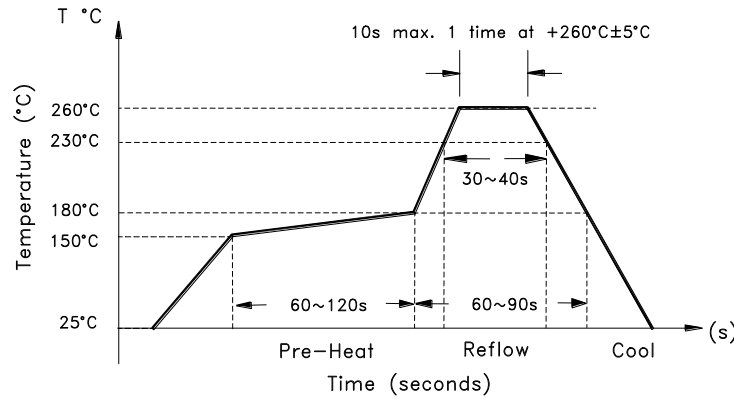

TAPE & REEL:

Packaging: 1000pcs/reel

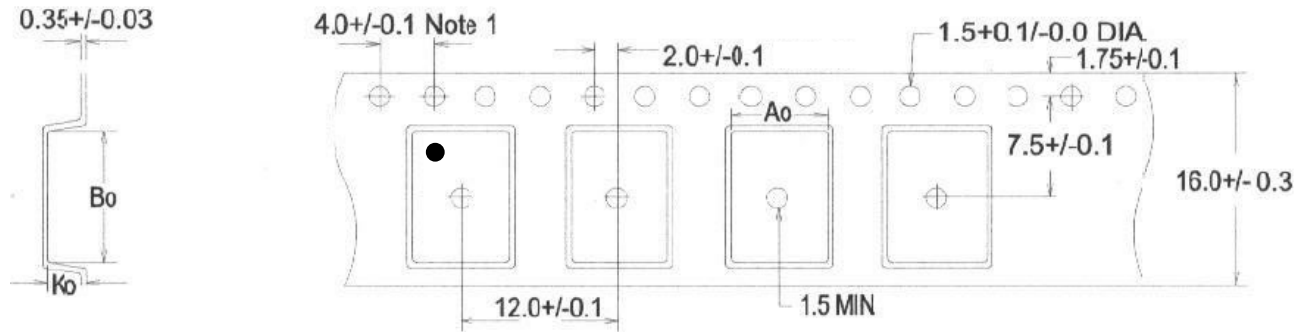

A0	B0	K0
7.10±0.1	9.60±0.1	3.00±0.1

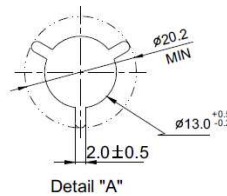
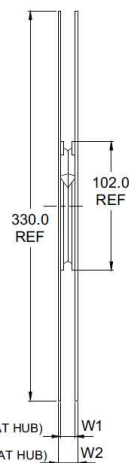
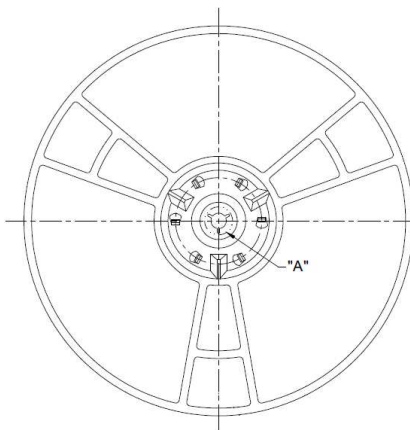

W1	W2
16.8+0.6/-0.4	22.2 max.

Dimensions: mm

ATTENTION: Abracon Corporation's products are COTS – Commercial-Off-The-Shelf products; suitable for Commercial, Industrial and, where designated, Automotive Applications. Abracon's products are not specifically designed for Military, Aviation, Aerospace, Life-dependant Medical applications or any application requiring high reliability where component failure could result in loss of life and/or property. For applications requiring high reliability and/or presenting an extreme operating environment, written consent and authorization from Abracon Corporation is required. Please contact Abracon Corporation for more information.

ABRACON IS
ISO9001:2008
CERTIFIED



2 Faraday, Suit#B, Irvine, California 92618 Revised: 10.16.14

tel:949-546-8000 | fax:949-546-8001

Visit www.abracon.com for Terms & Conditions of Sale