



Chipsmall Limited consists of a professional team with an average of over 10 year of expertise in the distribution of electronic components. Based in Hongkong, we have already established firm and mutual-benefit business relationships with customers from,Europe,America and south Asia,supplying obsolete and hard-to-find components to meet their specific needs.

With the principle of “Quality Parts,Customers Priority,Honest Operation,and Considerate Service”,our business mainly focus on the distribution of electronic components. Line cards we deal with include Microchip,ALPS,ROHM,Xilinx,Pulse,ON,Everlight and Freescale. Main products comprise IC,Modules,Potentiometer,IC Socket,Relay,Connector.Our parts cover such applications as commercial,industrial, and automotives areas.

We are looking forward to setting up business relationship with you and hope to provide you with the best service and solution. Let us make a better world for our industry!



## Contact us

Tel: +86-755-8981 8866 Fax: +86-755-8427 6832

Email & Skype: info@chipsmall.com Web: www.chipsmall.com

Address: A1208, Overseas Decoration Building, #122 Zhenhua RD., Futian, Shenzhen, China



# ASMG-ST00-00001

## 3W Tri-Color High Power LED

---

### Description

The Broadcom® 3W Tri-Color High Power LED Light Source is a high-performance, energy-efficient device that can handle high thermal and high driving current.

The low-profile package design is suitable for a wide variety of applications, especially where height is a constraint.

The package is compatible with the reflow soldering process. This will give more freedom and flexibility to the light source designer.

### Features

- Available in tri-color
- Energy efficient
- Compatible with reflow soldering process
- High current operation
- Long operation life
- Wide viewing angle
- Silicone encapsulation
- MSL 1 products

### Applications

- Sign backlight
- Retail display
- Commercial lighting
- Decorative lighting
- Architectural lighting

**CAUTION!** This LED is Class 1B ESD sensitive per ANSI/ESDA/JEDEC JS-001. Please observe appropriate precautions during handling and processing. Refer to Application Note AN-1142 for additional details.

# Package Dimensions

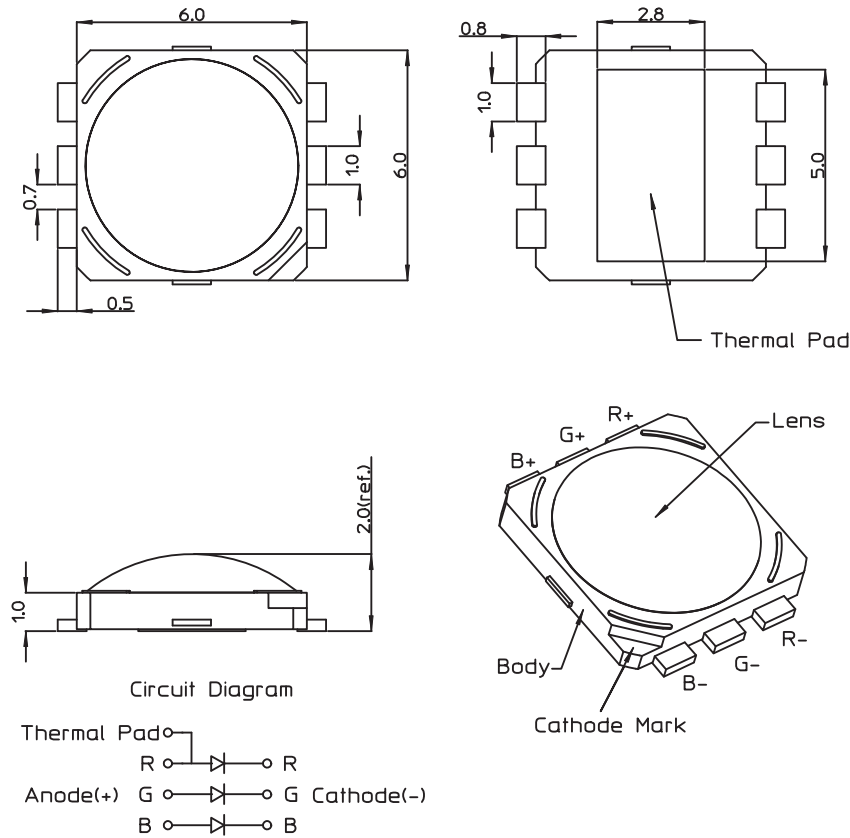

**NOTE:**

1. All dimensions are in millimeters (mm).
2. Tolerance is  $\pm 0.2$  mm unless otherwise specified.
3. Encapsulation = silicone.
4. Terminal finish = silver plating.
5. Thermal pad is connected to the anode of red.

## Device Selection Guide

$T_J = 25^\circ\text{C}$ ,  $I_F = 350$  mA.

Part Number	Color	Luminous Flux, $\Phi_V$ (lm) at 350 mA <sup>a, b</sup>			Dice Technology
		Min.	Typ.	Max.	
ASMG-ST00-00001	Red	45	55	65	AllnGaP
	Green	80	95	112	InGaN
	Blue	18	20	26	InGaN

a.  $\Phi_V$  is the total luminous flux output as measured with an integrating sphere at 25ms mono pulse condition.

b. Luminous flux tolerance =  $\pm 10\%$ .

## Absolute Maximum Ratings

Parameter	AllnGaP	InGaN	Unit
DC Forward Current <sup>a</sup>	350	350	mA
Peak Forward Current <sup>b</sup>	500	500	mA
Power Dissipation	980	1330	mW
Reverse Voltage	Not designed for reverse bias		
LED Junction Temperature	120		°C
Operating Temperature Range	-40 to +100		°C
Storage Temperature Range	-40 to +120		°C

a. Derate linearly as shown in Figure 7 and Figure 8.

b. Duty factor = 10%, frequency = 1 kHz.

## Optical Characteristics

$I_F = 350$  mA,  $T_J = 25^\circ\text{C}$ .

Color	Dominant Wavelength, $\lambda_d$ (nm) <sup>a, b</sup>			Peak Wavelength, $\lambda_p$ (nm)	Viewing Angle, $2\theta_{1/2}$ (°) <sup>c</sup>
	Min.	Typ.	Max.	Typ.	Typ.
Red	613.5	623.0	631.0	631.5	135
Green	515.0	525.0	535.0	518.5	170
Blue	455.0	465.0	475.0	456.5	135

a. The dominant wavelength is derived from the CIE Chromaticity Diagram and represents the perceived color of the device.

b. Tolerance =  $\pm 1$  nm.

c.  $2\theta_{1/2}$  is the off axis angle where the luminous intensity is half of the peak intensity.

## Electrical Characteristics

$T_J = 25^\circ\text{C}$ .

Color	Forward Voltage, $V_F$ (V) <sup>a</sup> at $I_F = 350$ mA			Reverse Current, $I_R$ ( $\mu\text{A}$ ) at $V_R = 5\text{V}$	Thermal Resistance, $R_{\theta J-S}$ (°C/W) <sup>b</sup>
	Min.	Typ.	Max.		Typ.
Red	1.8	2.2	2.8	Not designed for reverse bias	6
Green	2.8	3.4	3.8		10
Blue	2.8	3.4	3.8		6

a. Tolerance =  $\pm 0.1\text{V}$ .

b. Thermal resistance from LED junction to solder point.

# Part Numbering System

A S M G - S T 0 0 - 0 

x <sub>1</sub>	x <sub>2</sub>	x <sub>3</sub>
----------------	----------------	----------------

 1

Code	Description	Option		
x <sub>1</sub> x <sub>2</sub>	Flux bin selection	00	Red:	45–65 lm
			Green:	80–112 lm
			Blue:	18–26 lm
x <sub>3</sub>	Color bin selection	0	Red:	Bins 2 and 4
			Green:	Bins A, 1, 2, and 3
			Blue:	Bins A, 1, 2, and 3

## Bin Information

### Luminous Flux Bin Limit

Color	Luminous flux (lm) at 350 mA	
	Min.	Max.
Red	45	65
Green	80	112
Blue	18	26

Tolerance = ±10%.

### Color Bin Limits (BIN)

Color	Bin ID	Dominant Wavelength (nm) at 350 mA	
		Min.	Max.
Red	2	613.5	620.5
	4	620.5	631.0
Green	A	515.0	520.0
	1	520.0	525.0
	2	525.0	530.0
Blue	3	530.0	535.0
	A	455.0	460.0
	1	460.0	465.0
	2	465.0	470.0
	3	470.0	475.0

Tolerance = ±1 nm.

Example of bin information on reel and packaging label:

BIN: 2A3 → Red color bin 2  
 → Green color bin A  
 → Blue color bin 3

Figure 1: Relative Luminous Flux vs. Mono Pulse Current

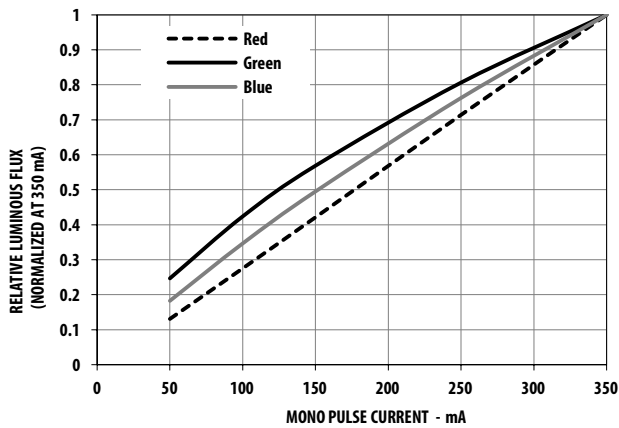

Figure 2: Forward Current vs. Forward Voltage

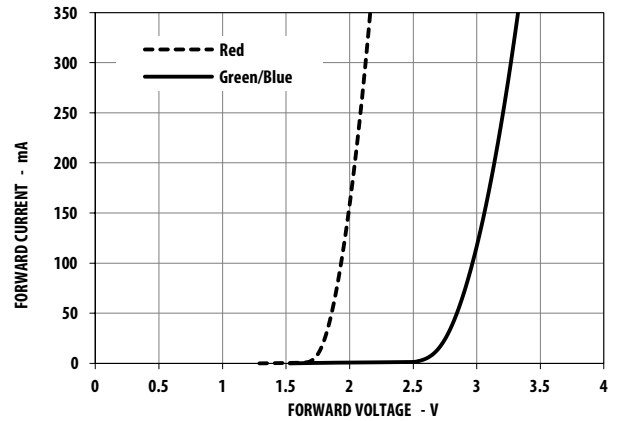

Figure 3: Dominant Wavelength Shift vs. Mono Pulse Current

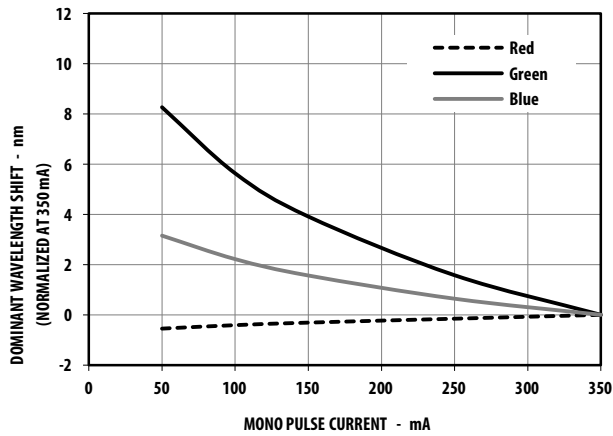

Figure 4: Relative Light Output vs. Junction Temperature

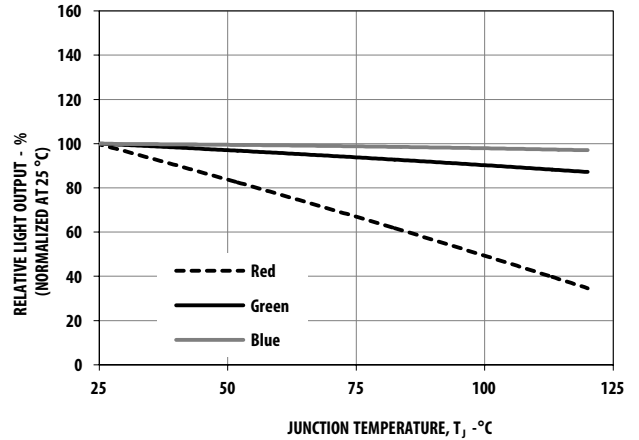

Figure 5: Forward Voltage Shift vs. Junction Temperature

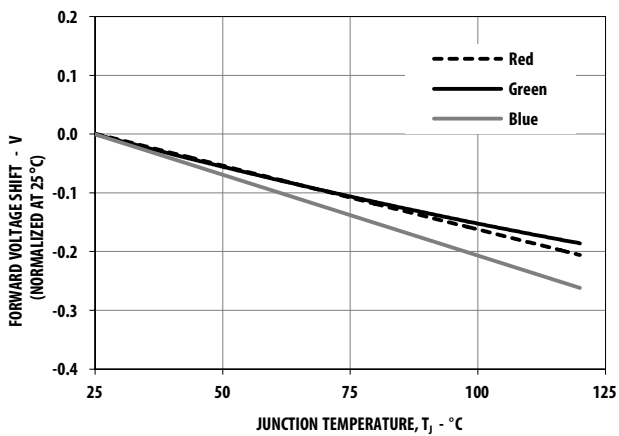
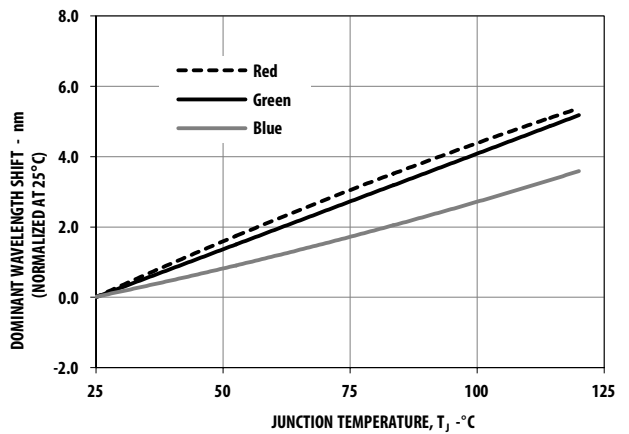
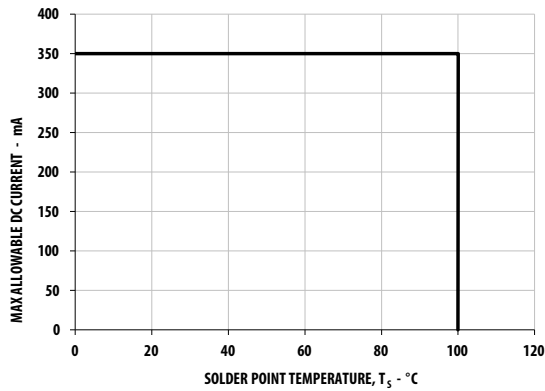

Figure 6: Dominant Wavelength Shift vs. Junction Temperature



**Figure 7: Derating Curve According to Solder Point Temperature ( $T_S$ )**



**Figure 8: Derating Curve According to Ambient Temperature ( $T_A$ )**. Derated based on  $T_{JMAX} = 120^\circ\text{C}$ ,  $R\theta_{J-A} = 30^\circ\text{C/W}$  for Red and Blue and  $R\theta_{J-A} = 34^\circ\text{C/W}$  for Green.

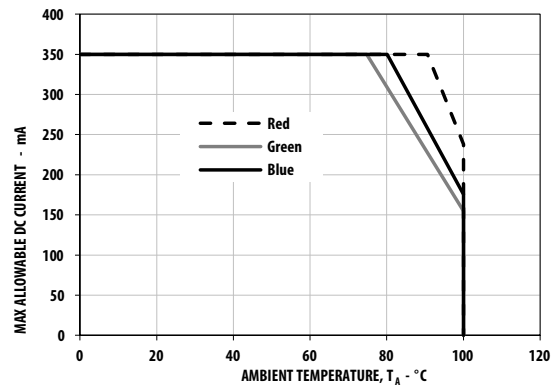

**Figure 9: Pulse Handling Capability at  $T_S \leq 100^\circ\text{C}$  for AlInGaP**

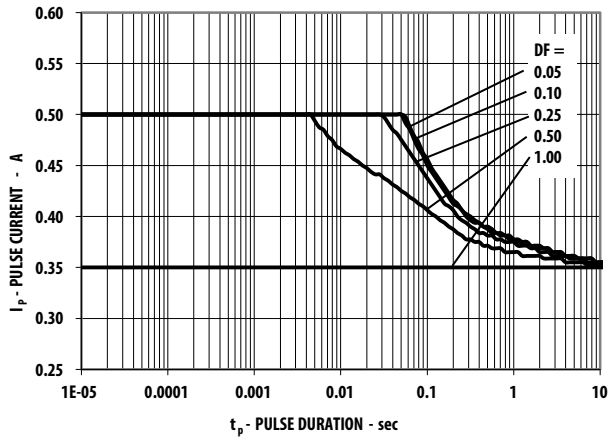

**Figure 10: Pulse Handling Capability at  $T_S \leq 100^\circ\text{C}$  for InGaN**

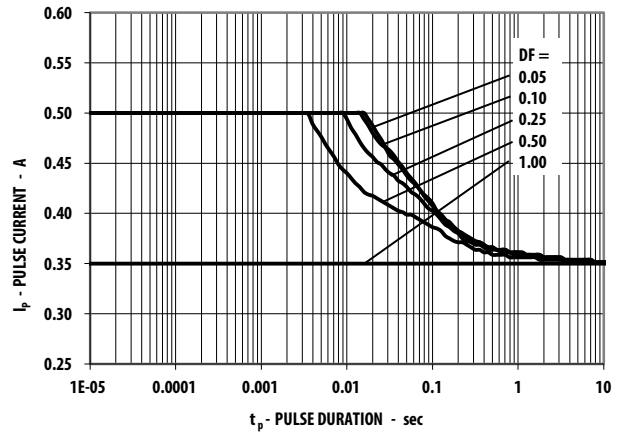

**Figure 11: Radiation Pattern for Red**

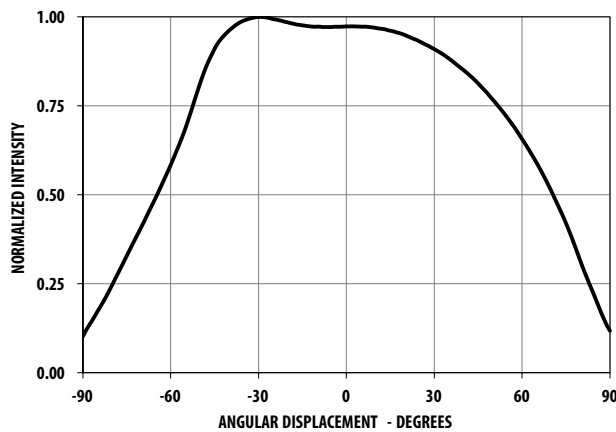

**Figure 12: Radiation Pattern for Green**

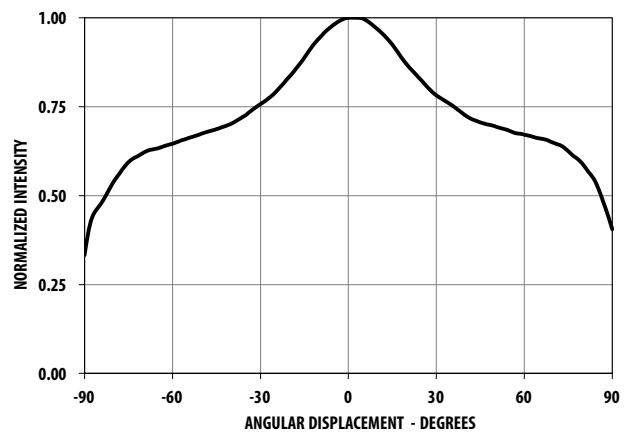

Figure 13: Radiation Pattern for Blue

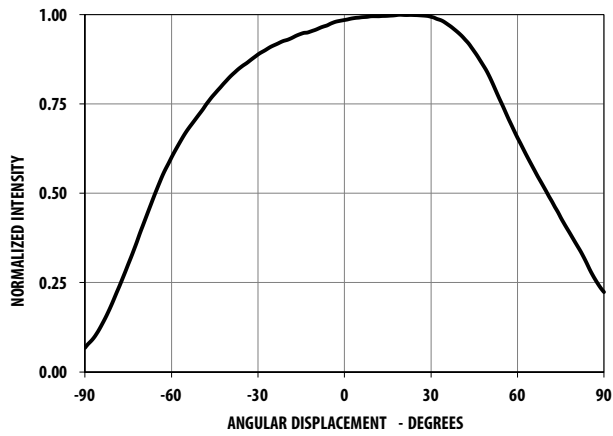

Figure 14: Spectral Power Distribution

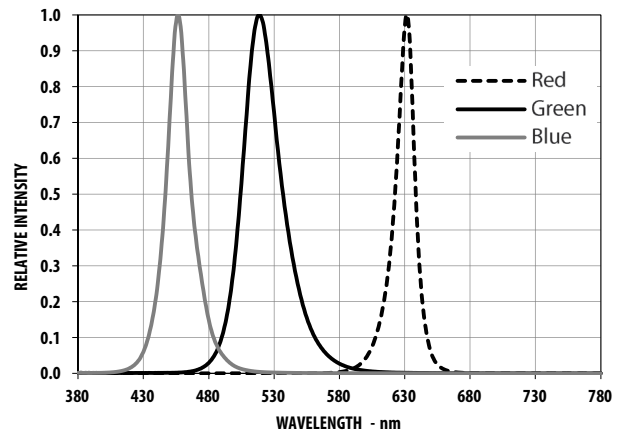
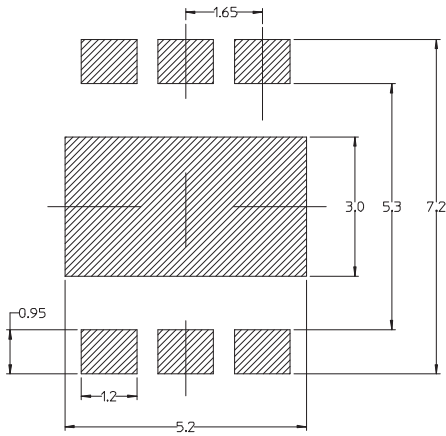

Figure 15: Recommended Soldering Land Pattern (mm)



Units: mm.



**Figure 16: Carrier Tape Dimensions**

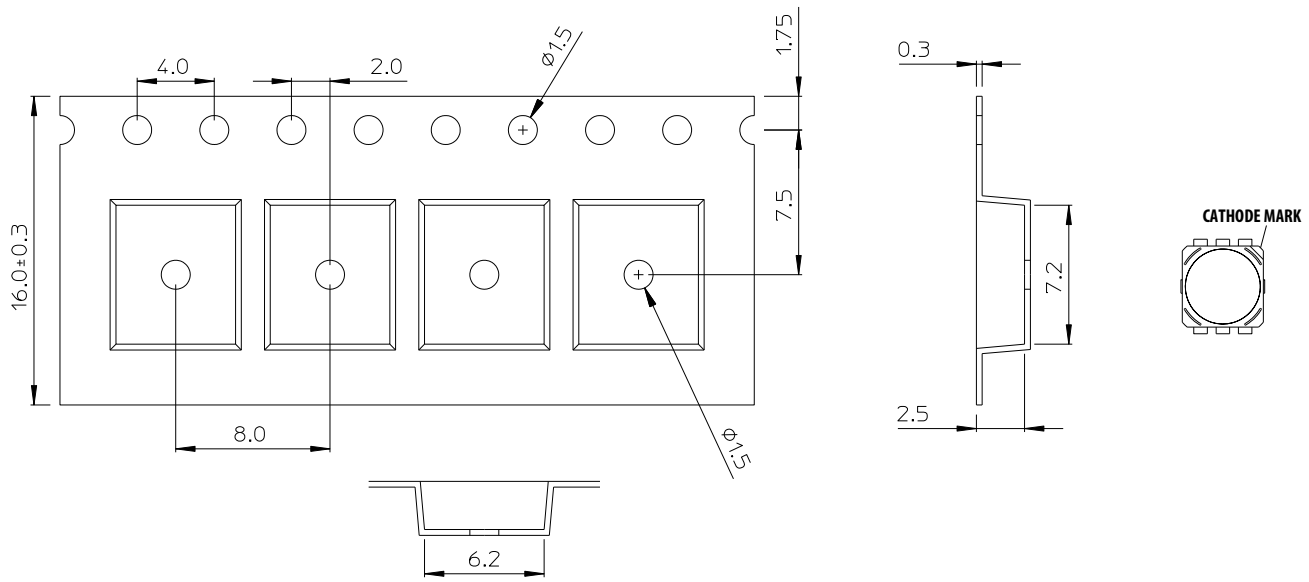

**NOTE:**

1. Drawing not to scale.
2. All dimensions are in millimeters.
3. Tolerance is  $\pm 0.10$  mm unless otherwise specified.

Figure 17: Reel Dimensions

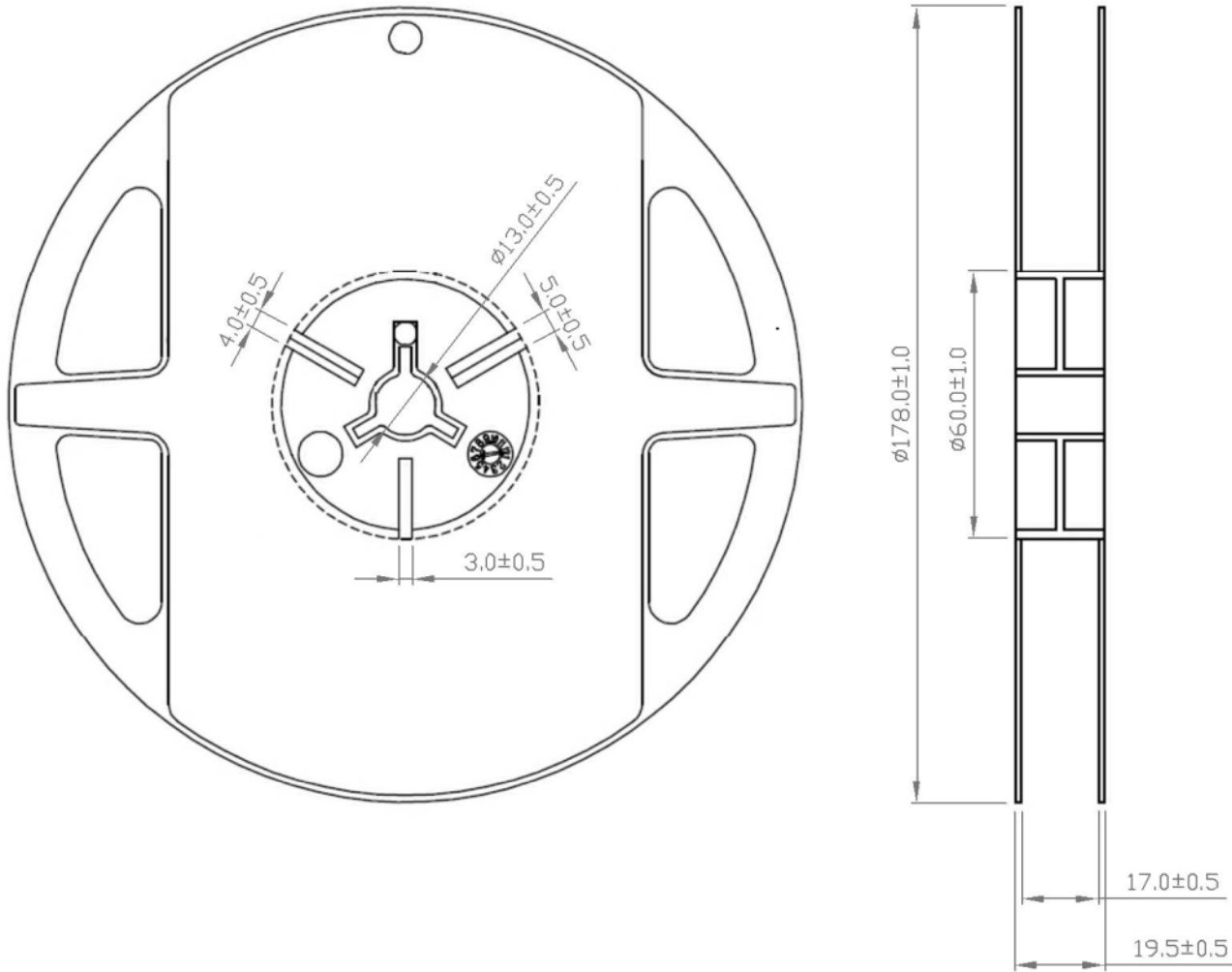

**NOTE:**

1. 500 pieces per reel.
2. Drawing not to scale
3. All dimensions are in millimeters.

## Soldering

Recommended reflow soldering conditions:

**Figure 18: Recommended Reflow Soldering Profile**

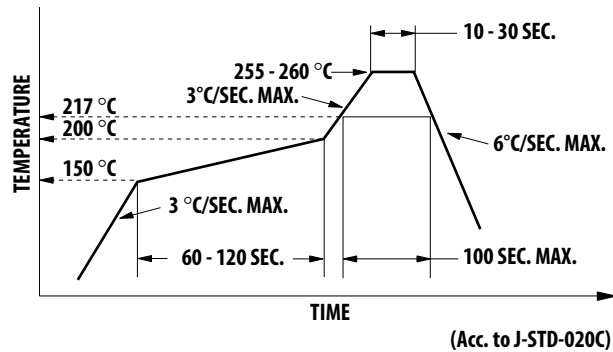

- Do not perform reflow soldering more than twice.
- Do not apply any pressure or force on the LED during reflow and after reflow when the LED is still hot.
- Use reflow soldering to solder the LED. Hot plate should only be used for rework if unavoidable but must be strictly controlled to the following conditions:
  - LED temperature = 260°C max.
  - Time at maximum temperature = 20s max.
- Confirm beforehand whether the functionality and performance of the LED is affected by soldering with hot plate.
- Hand soldering is not recommended.

## Precautionary Notes

### Handling Precautions

The encapsulation material of the LED is made of silicone for better product reliability. Compared to epoxy encapsulant that is hard and brittle, silicone is softer and flexible. Observe special handling precautions during assembly of silicone encapsulated LED products. Failure to comply might lead to damage and premature failure of the LED. Do refer to Application Note AN5288, *Silicone Encapsulation for LED: Advantages and Handling Precautions* for more information.

- Do not poke sharp objects into the silicone encapsulant. Sharp objects, such as tweezers or syringes, might apply excessive force or even pierce through the silicone and induce failures to the LED die or wire bond.

- Do not touch the silicone encapsulant. Uncontrolled force acting on the silicone encapsulant might result in excessive stress on the wire bond. Hold the LED only by the body.
- Do not stack assembled PCBs together. Use an appropriate rack to hold the PCBs.
- The surface of the silicone material attracts dust and dirt easier than epoxy due to its surface tackiness. To remove foreign particles on the surface of silicone, use a cotton bud with isopropyl alcohol (IPA). During cleaning, rub the surface gently without putting too much pressure on the silicone. Ultrasonic cleaning is not recommended.
- For automated pick-and-place, Broadcom has tested the following nozzle size to work well with this LED. However, due to the possibility of variations in other parameters, such as pick-and-place machine maker/model and other settings of the machine, verify that the selected nozzle will not cause damage to the LED.

**Figure 19: Nozzle Size**

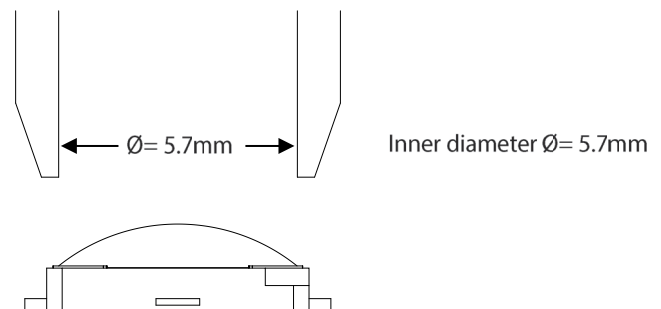

- Storage
  - The soldering terminals of these LEDs are silver plated. If the LEDs are exposed in an ambient environment for too long, the silver plating might be oxidized and thus affecting its solderability performance. As such, keep unused LEDs in a sealed moisture barrier bag (MBB) with desiccant or in desiccator at <5%RH.

## Application Precautions

- The drive current of the LED must not exceed the maximum allowable limit across temperature as stated in the data sheet. Constant current driving is recommended to ensure consistent performance.

- The LED is not intended for reverse bias. Use other appropriate components for such purposes. When driving the LED in matrix form, ensure that the reverse bias voltage does not exceed the allowable limit of the LED.
- Do not use the LED in the vicinity of material with sulfur content, in environments of high gaseous sulfur compound and corrosive elements. Examples of materials that may contain sulfur are rubber gaskets, RTV (room temperature vulcanizing) silicone rubber, rubber gloves, and so on. Prolonged exposure to such environments may affect the optical characteristics and product life.
- Avoid rapid changes in ambient temperature especially in high-humidity environments as this will cause condensation on the LED.
- If the LED is intended to be used in harsh or outdoor environments, protect the LED by means of protective cover against damages caused by rain water, dust, oil, corrosive gases, external mechanical stress, and so on.

To measure the soldering point temperature, a thermocouple can be mounted on the  $T_S$  point as shown in the preceding figure. Verify the  $T_S$  of the LED in the final product to ensure that the LEDs are operated within all maximum ratings stated in the datasheet.

## Eye Safety and Precautions

LEDs may pose optical hazards when in operation. Do not look directly at operating LEDs as it may be harmful to the eyes. For safety reasons, use appropriate shielding or personnel protection equipment.

## Thermal Management

Optical, electrical and reliability characteristics of LED are affected by temperature. The junction temperature ( $T_J$ ) of the LED must be kept below allowable limit at all times.  $T_J$  can be calculated as follows:

$$T_J = T_S + R_{\theta J-S} \times I_F \times V_{Fmax}$$

where  $T_S$  = LED solder point temperature as shown in the following figure ( $^{\circ}\text{C}$ )

$R_{\theta J-S}$  = Thermal resistance from junction to solder point ( $^{\circ}\text{C}/\text{W}$ )

$I_F$  = Forward current (A)

$V_{Fmax}$  = Maximum forward voltage (V)

**Figure 20: Thermal Management**

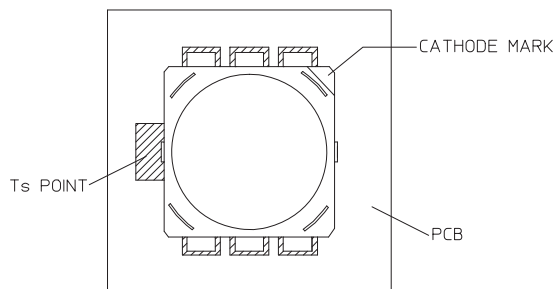

## Disclaimer

Broadcom's products and software are not specifically designed, manufactured, or authorized for sale as parts, components, or assemblies for the planning, construction, maintenance, or direct operation of a nuclear facility or for use in medical devices or applications. The customer is solely responsible, and waives all rights to make claims against Broadcom or its suppliers, for all loss, damage, expense, or liability in connection with such use.

Broadcom, the pulse logo, Connecting everything, Avago Technologies, Avago, and the A logo are among the trademarks of Broadcom and/or its affiliates in the United States, certain other countries, and/or the EU.

Copyright © 2018 Broadcom. All Rights Reserved.

The term "Broadcom" refers to Broadcom Inc. and/or its subsidiaries. For more information, please visit [www.broadcom.com](http://www.broadcom.com).

Broadcom reserves the right to make changes without further notice to any products or data herein to improve reliability, function, or design. Information furnished by Broadcom is believed to be accurate and reliable. However, Broadcom does not assume any liability arising out of the application or use of this information, nor the application or use of any product or circuit described herein, neither does it convey any license under its patent rights nor the rights of others.

