



Chipsmall Limited consists of a professional team with an average of over 10 year of expertise in the distribution of electronic components. Based in Hongkong, we have already established firm and mutual-benefit business relationships with customers from,Europe,America and south Asia,supplying obsolete and hard-to-find components to meet their specific needs.

With the principle of "Quality Parts,Customers Priority,Honest Operation,and Considerate Service",our business mainly focus on the distribution of electronic components. Line cards we deal with include Microchip,ALPS,ROHM,Xilinx,Pulse,ON,Everlight and Freescale. Main products comprise IC,Modules,Potentiometer,IC Socket,Relay,Connector.Our parts cover such applications as commercial,industrial, and automotives areas.

We are looking forward to setting up business relationship with you and hope to provide you with the best service and solution. Let us make a better world for our industry!



## Contact us

Tel: +86-755-8981 8866 Fax: +86-755-8427 6832

Email & Skype: info@chipsmall.com Web: www.chipsmall.com

Address: A1208, Overseas Decoration Building, #122 Zhenhua RD., Futian, Shenzhen, China



### Data Sheet



---

#### Description

This family of SMT LEDs packaged in the form of PLCC-6 with separate heat path for each LED dice, enabling it to be driven at higher current.

Individually addressable pin-outs give higher flexibility in circuitry design. With closely matched radiation pattern along the package's x-axis, these LEDs are suitable for indoor full color display application.

For easy pick & place, the LEDs are shipped in tape and reel. Every reel is shipped from a single intensity and color bin for better uniformity. The full black body of the LED provides extreme contrast enhancement for short distance viewing of fine pitch full color display.

These LEDs are compatible with reflow soldering process.

**CAUTION** LEDs are Class 1C ESD sensitive. Please observe appropriate precautions during handling and processing. Please refer to Avago Application Note AN-1142 for additional details.

#### Features

- Standard PLCC-6 package (Plastic Leaded Chip Carrier) with individual addressable pin-out for higher flexibility of driving configuration
  - High reliability LED package with silicone encapsulation
  - High brightness using AlInGaP and InGaN dice technologies
  - Typical viewing angle 120°
  - Compatible with reflow soldering process
  - JEDEC MSL 2a
  - Water-Resistance (IPX6\*) per IEC 60529:2001
- \* The test is conducted on component level by mounting the components on PCB with proper potting to protect the leads. It is strongly recommended that customers perform necessary tests on the components for their final application.

#### Applications

- Indoor full color display

## Package Dimensions

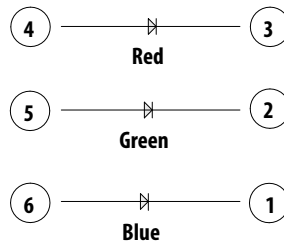
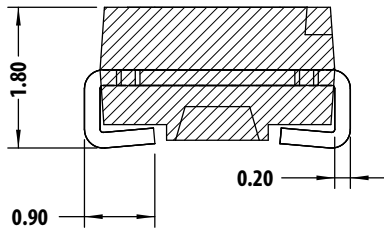
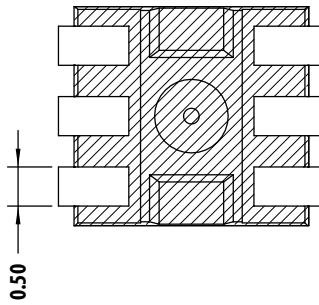
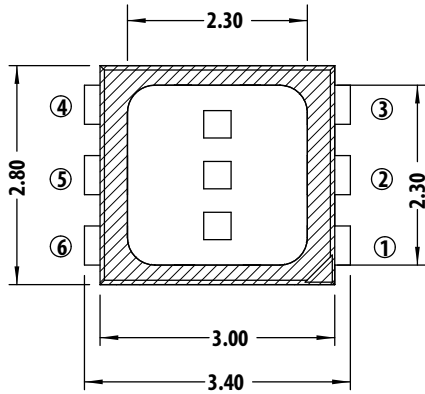

## Lead Configuration

1	Cathode (Blue)
2	Cathode (Green)
3	Cathode (Red)
4	Anode (Red)
5	Anode (Green)
6	Anode (Blue)

### NOTE

1. All dimensions are in millimeters (mm).
2. Unless otherwise specified, tolerance is  $\pm 0.20$  mm.
3. Encapsulation = silicone.
4. Terminal finish = silver plating.

**Table 1. Absolute Maximum Ratings (T<sub>J</sub> = 25 °C)**

Parameter	Red	Green & Blue	Unit
DC forward current <sup>a</sup>	50	30	mA
Peak forward current <sup>b</sup>	100	100	mA
Power dissipation	125	114	mW
Reverse voltage <sup>c</sup>	4		V
Junction temperature	125		°C
Operating temperature range	-40 to +110		°C
Storage temperature range	-40 to +120		°C

- a. Derate linearly as shown in Figure 7 to Figure 10.
- b. Duty Factor = 10%, frequency = 1 kHz.
- c. Driving the LED in reverse bias condition is suitable for the short term only.

**Table 2. Optical Characteristics (T<sub>J</sub> = 25 °C)**

Color	Luminous Intensity, I <sub>V</sub> (mcd) @ I <sub>F</sub> = 20 mA <sup>a</sup>			Dominant Wavelength, λ <sub>d</sub> (nm) @ I <sub>F</sub> = 20 mA <sup>b</sup>			Peak Wavelength, λ <sub>p</sub> (nm) @ I <sub>F</sub> = 20 mA	Viewing Angle, 2θ <sub>1/2</sub> (°) <sup>c</sup>	Luminous Efficacy, η <sub>v</sub> (lm/W) <sup>d</sup>	Luminous Efficiency, η <sub>e</sub> (lm/W)
	Min.	Typ.	Max.	Min.	Typ.	Max.	Typ.	Typ.	Typ.	Typ.
Red	355	450	715	618	622	628	629	120	210	22
Green	450	560	900	525	530	537	521	120	535	25
Blue	140	180	285	465	470	477	464	120	84	5

- a. The luminous intensity I<sub>v</sub> is measured at the mechanical axis of the LED package at a single current pulse condition. The actual peak of the spatial radiation pattern may not be aligned with the axis.
- b. The dominant wavelength is derived from the CIE Chromaticity Diagram and represents the perceived color of the device.
- c. θ<sub>1/2</sub> is the off-axis angle where the luminous intensity is 1/2 the peak intensity.
- d. Φ<sub>v</sub> is the total luminous flux output as measured with an integrating sphere at mono pulse condition.

**Table 3. Electrical Characteristics (T<sub>J</sub> = 25 °C)**

Color	Forward Voltage, V <sub>F</sub> (V) @ I <sub>F</sub> = 20 mA <sup>a</sup>			Reverse Voltage, V <sub>R</sub> @ I <sub>R</sub> = 100 μA <sup>b</sup>	Reverse Voltage, V <sub>R</sub> @ I <sub>R</sub> = 10 μA <sup>b</sup>	Thermal Resistance, Rθ <sub>J-S</sub> (°C/W)	
	Min.	Typ.	Max.	Min.	Min.	1 Chip On	3 Chips On
Red	1.8	2.1	2.5	4.0	—	280	280
Green	2.8	3.2	3.8	—	4.0	180	230
Blue	2.8	3.2	3.8	—	4.0	180	230

- a. Tolerance = ±0.1V.
- b. Indicates product final testing condition. Long-term reverse bias is not recommended.

## Part Numbering System

A S M T - Y T C 2 - 0 A A 0 2

x1

x2 x3 x4 x5

Code	Description	Option		
x1	Package type	C	White surface	
x2	Minimum intensity bin	A	Red: bin T2	Red: bin T2, U1, U2
			Green: bin U1	Green: bin U1, U2, V1
			Blue: bin R1	Blue: bin R2, S1, S2
x3	Number of intensity bins	A	3 intensity bins from minimum	
x4	Color bin combination	0	Red: full distribution	
			Green: bin A, B, C	
			Blue: bin A, B, C, D, E	
x5	Test option	2	Test current = 20 mA	

## Table 4. Bin Information

### Intensity Bins (CAT)

Bin ID	Min (mcd)	Max (mcd)
R2	140.0	180.0
S1	180.0	224.0
S2	224.0	285.0
T1	285.0	355.0
T2	355.0	450.0
U1	450.0	560.0
U2	560.0	715.0
V1	715.0	900.0

Tolerance:  $\pm 12\%$

### Color Bins (BIN) – Green

Bin ID	Dominant Wavelength (nm)		Chromaticity Coordinate (for Reference)	
	Min.	Max.	Cx	Cy
A	525.0	531.0	0.1142	0.8262
			0.1799	0.6783
			0.2138	0.6609
			0.1625	0.8012
B	528.0	534.0	0.1387	0.8148
			0.1971	0.6703
			0.2298	0.6507
			0.1854	0.7867
C	531.0	537.0	0.1625	0.8012
			0.2138	0.6609
			0.2454	0.6397
			0.2077	0.7711

Tolerance:  $\pm 1$  nm.

### Color Bins (BIN) – Red

Bin ID	Dominant Wavelength (nm)		Chromaticity Coordinate (for Reference)	
	Min.	Max.	Cx	Cy
—	618.0	628.0	0.6873	0.3126
			0.6696	0.3136
			0.6866	0.2967
			0.7052	0.2948

Tolerance:  $\pm 1$  nm.

### Color Bins (BIN) – Blue

Bin ID	Dominant Wavelength (nm)		Chromaticity coordinate (for Reference)	
	Min.	Max.	Cx	Cy
A	465.0	469.0	0.1355	0.0399
			0.1751	0.0986
			0.1680	0.1094
			0.1267	0.0534
B	467.0	471.0	0.1314	0.0459
			0.1718	0.1034
			0.1638	0.1167
C	469.0	473.0	0.1267	0.0534
			0.1680	0.1094
			0.1593	0.1255
			0.1158	0.0736
D	471.0	475.0	0.1215	0.0626
			0.1638	0.1167
			0.1543	0.1361
			0.1096	0.0868
E	473.0	477.0	0.1158	0.0736
			0.1593	0.1255
			0.1489	0.1490
			0.1028	0.1029

Tolerance:  $\pm 1$  nm.

## Characteristics

Figure 1 Relative Spectral Emission

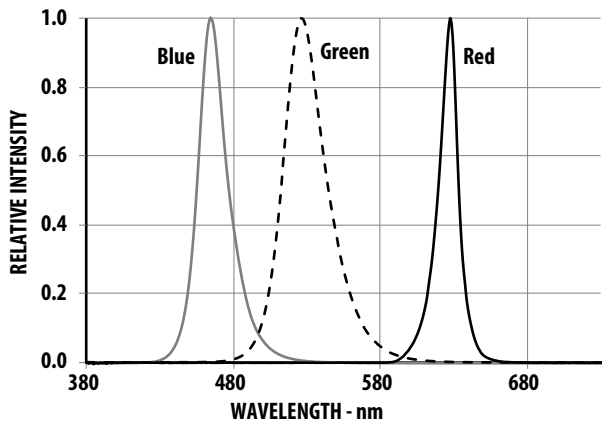

Figure 2 Forward Current vs. Forward Voltage

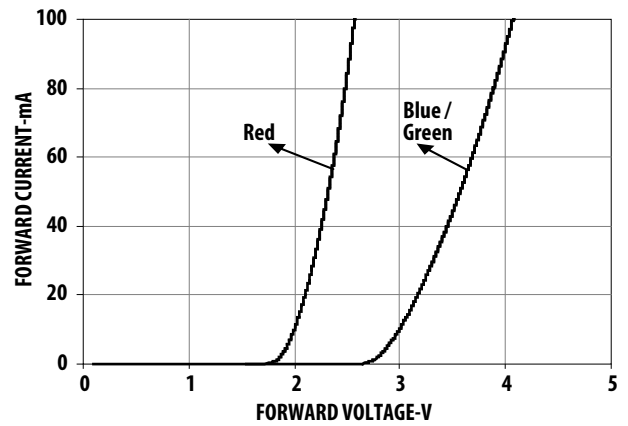

Figure 3 Relative Luminous Intensity vs. Forward Current

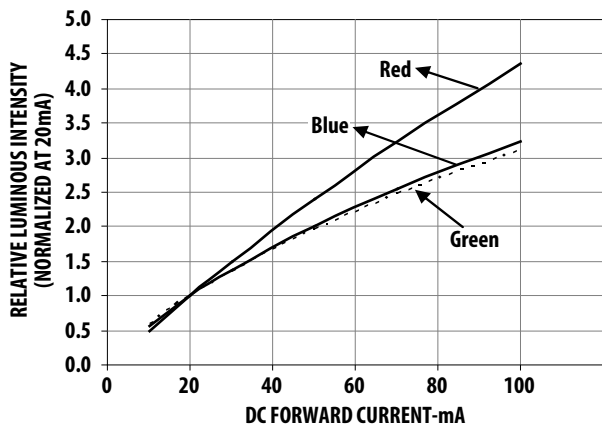

Figure 4 Dominant Wavelength Shift vs. Forward Current

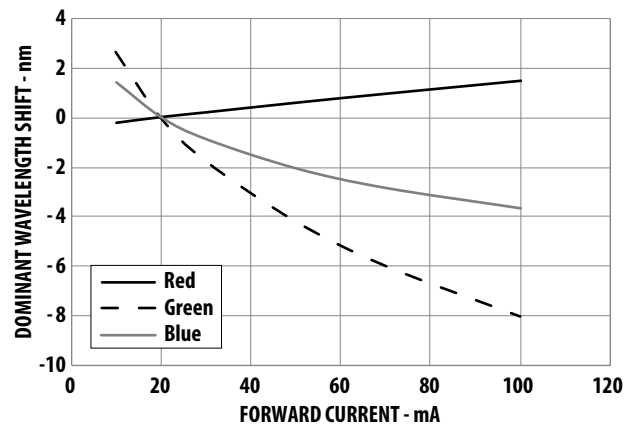

Figure 5 Relative Luminous Intensity vs. Junction Temperature

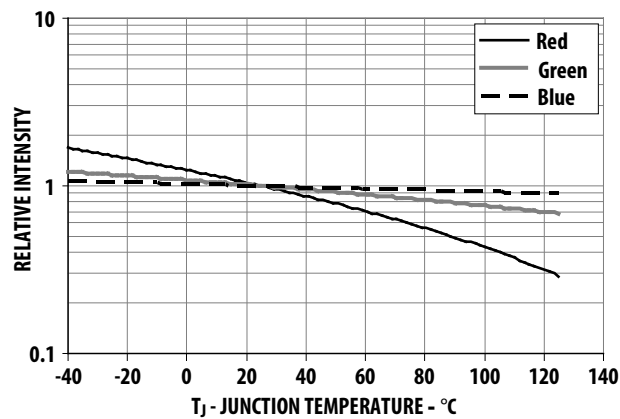
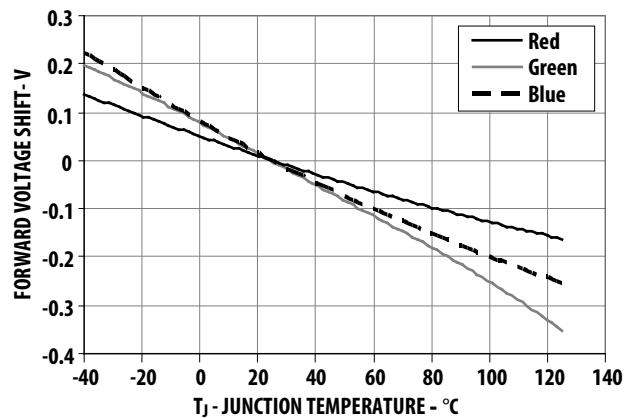
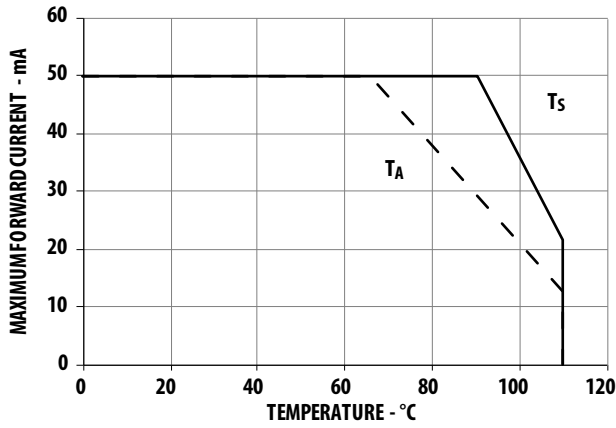

Figure 6 Forward Voltage Shift vs. Junction Temperature



**Figure 7 Maximum Forward Current vs. Temperature for Red (1 Chip On)**



**Figure 8 Maximum Forward Current vs. Temperature for Red (3 Chips On)**

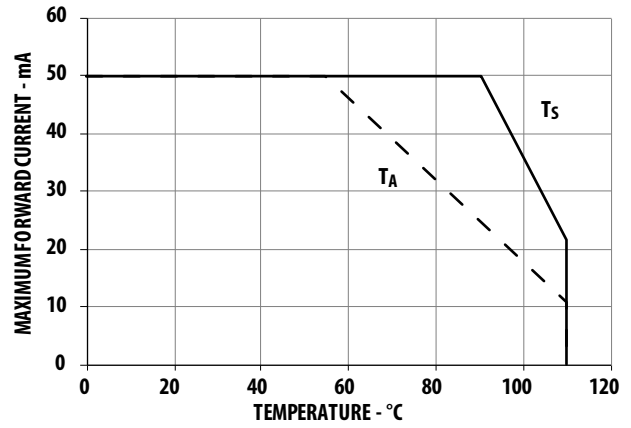

**Figure 9 Maximum Forward Current vs. Temperature for Green and Blue (1 Chip On)**

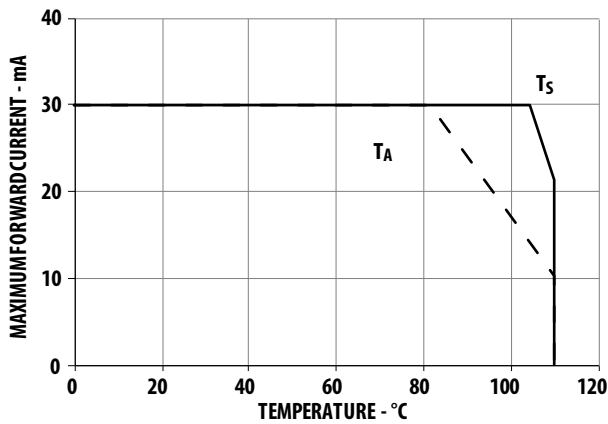

**Figure 10 Maximum Forward Current vs. Temperature for Green and Blue (3 Chips On)**

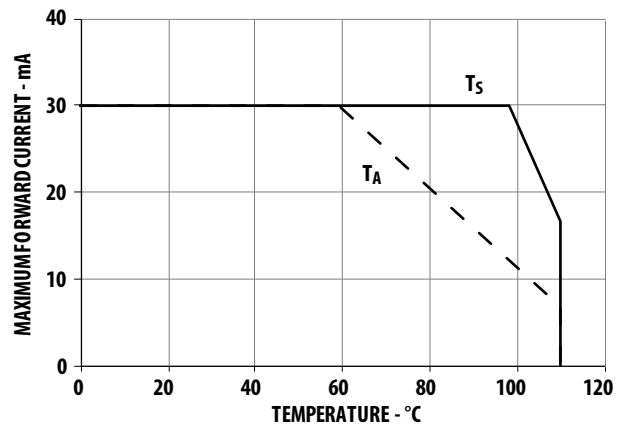

**NOTE** Maximum forward current graphs based on ambient temperature,  $T_A$  are with reference to thermal resistance  $R\theta_{J-A}$  as follows. For more details, see Precautionary Notes (4).

Condition	Thermal Resistance from LED Junction to Ambient, $R\theta_{J-A}$ (°C/W)	
	Red	Green and Blue
1 chip on	473	373
3 chips on	563	563



Figure 11 Radiation Pattern Along X-Axis of the Package

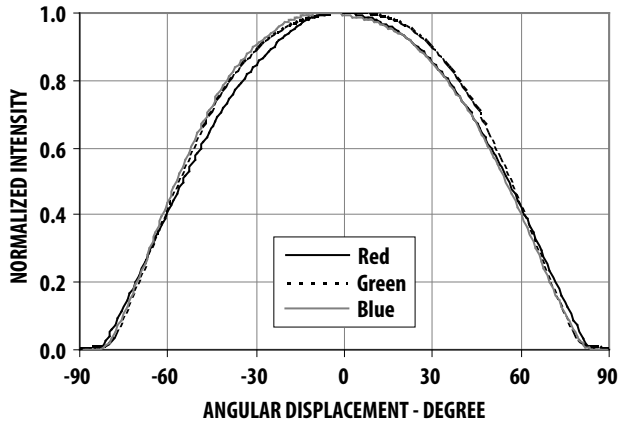

Figure 12 Radiation Pattern Along Y-Axis of the Package

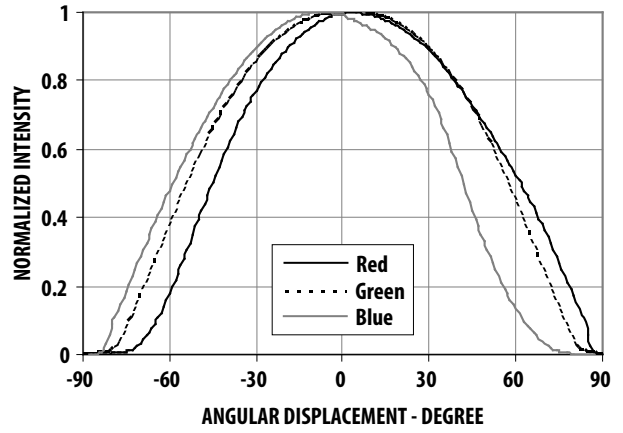
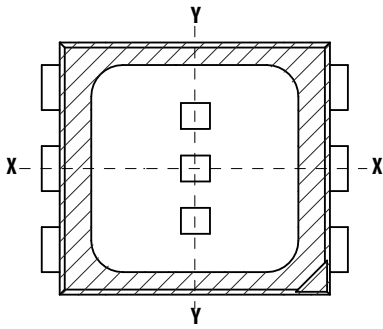
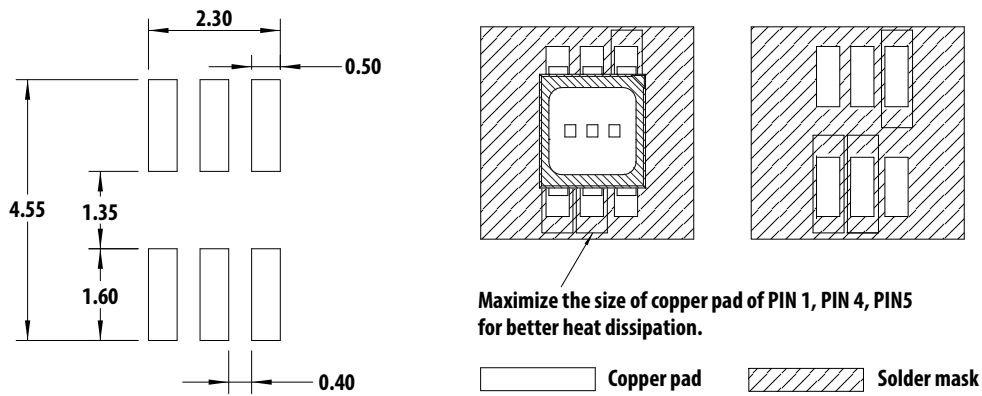

Figure 13 Illustration of Package Axis for Radiation Pattern



**Figure 14 Recommended Soldering Land Pattern**



**Figure 15 Carrier Tape Dimensions**

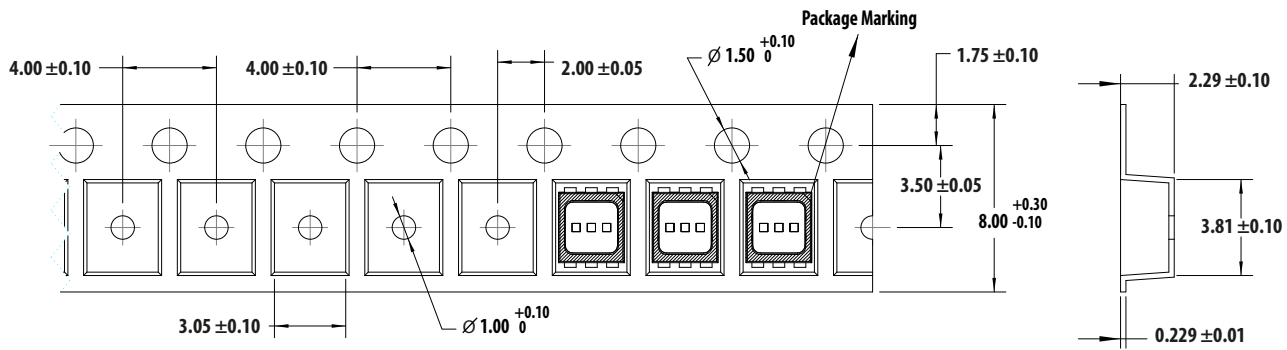

**Figure 16 Reeling Orientation**

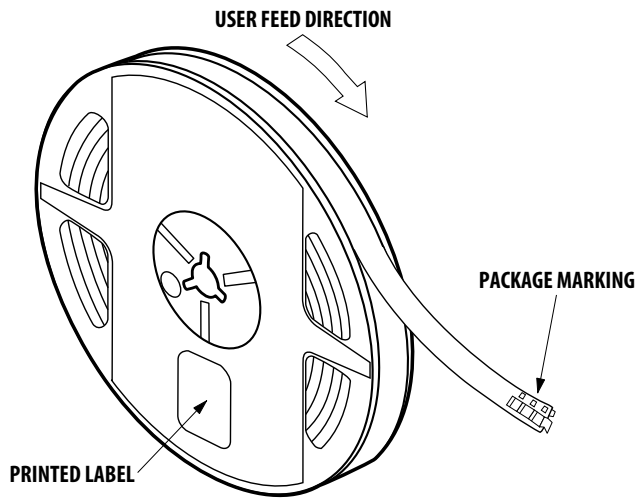

**Figure 17 Reel Dimensions**

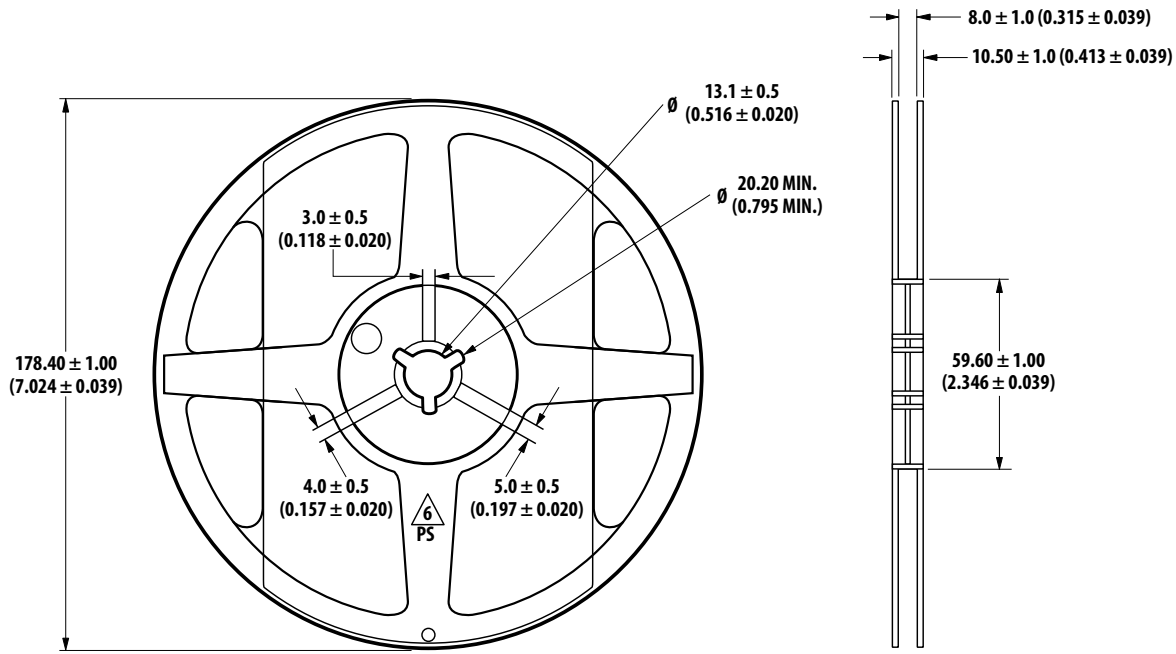









## Packing Label

(i) Standard label (attached on moisture barrier bag)

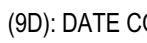
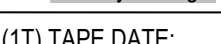
<p>(1P) Item: <b>Part Number</b>  </p>		<p><b>AVAGO</b>          TECHNOLOGIES          STANDARD LABEL LS0002          RoHS Compliant Halogen Free          e4 Max Temp 260C MSL2a</p>	
<p>(1T) Lot: <b>Lot Number</b>  </p>	<p>(Q) QTY: <b>Quantity</b>  </p>		
<p>LPN:  </p>	<p>CAT: <b>Intensity Bin</b>  </p>		
<p>(9D)MFG Date: <b>Manufacturing Date</b>  </p>	<p>BIN: <b>Color Bin</b>  </p>		
<p>(P) Customer Item:  </p>			
<p>(V) Vendor ID:  </p>	<p>(9D) Date Code: <b>Date Code</b>  </p>		
<p>DeptID:  </p>	<p>Made In: <b>Country of Origin</b>  </p>		

(ii) Baby label (attached on plastic reel)

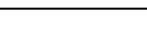
<p>(1P) PART #: <b>Part Number</b>  </p>		<p><b>AVAGO</b>          TECHNOLOGIES          BABY LABEL COSB001B V0.0</p>	
<p>(1T) LOT #: <b>Lot Number</b>  </p>	<p>QUANTITY: <b>Packing Quantity</b>  </p>		
<p>(9D)MFG DATE: <b>Manufacturing Date</b>  </p>	<p>(9D): DATE CODE:  </p>		
<p>C/O: <b>Country of Origin</b>  </p>	<p>D/C: <b>Date Code</b> VF:  </p>		
<p>(1T) TAPE DATE:  </p>	<p>CAT: <b>INTENSITY BIN</b>  </p>		
	<p>BIN: <b>COLOR BIN</b>  </p>		

Example of luminous intensity (lv) bin information on label:

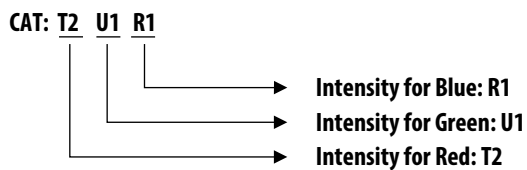

Example of color bin information on label:

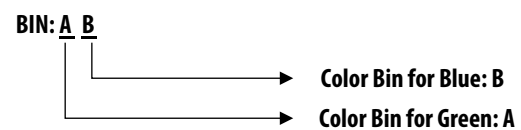

**NOTE** There is no color bin ID for Red color as there is only one range, as stated in Table 4.

## Soldering

Recommended reflow soldering condition

### (i) Leaded Reflow Soldering

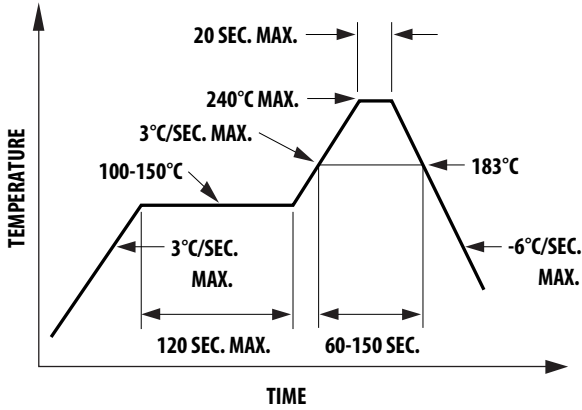

1. Reflow soldering must not be done more than 2 times. Make sure the necessary precautions are observed for handling moisture-sensitive devices as stated in the following section.
2. Recommended board reflow direction:

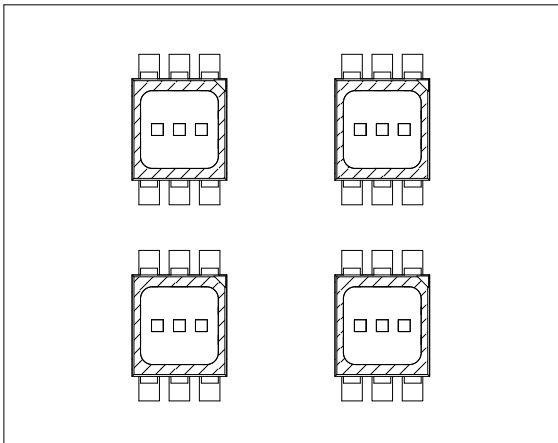

### (ii) Lead-Free Reflow Soldering

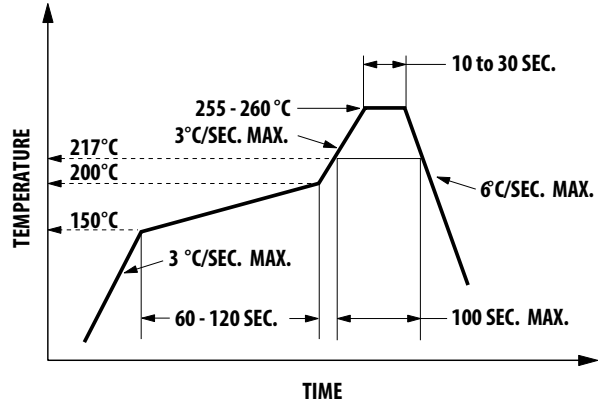

3. Do not apply any pressure or force on the LED during reflow and after reflow when the LED is still hot.
4. It is preferred to use reflow soldering to solder the LED. Use hand soldering for rework if this is unavoidable, but it must be strictly controlled to the following conditions:
  - Soldering iron tip temperature = 320 °C max
  - Soldering duration = 3 sec max
  - Number of cycles = 1 only
  - Power of soldering iron = 50W max
5. Do not touch the LED body with a hot soldering iron except the soldering terminals as it may cause damage to the LED.
6. For de-soldering, it is recommended to use a double flat tip.
7. You are advised to confirm beforehand whether hand soldering will affect the functionality and performance of the LED.

## Precautionary Notes

### 1. Handling precautions

The encapsulation material of the LED is made of silicone for better product reliability. Compared to epoxy encapsulant that is hard and brittle, silicone is softer and flexible. Special handling precautions need to be observed during assembly of silicone encapsulated LED products. Failure to comply might lead to damage and premature failure of the LED. Do refer to Application Note AN5288, *Silicone Encapsulation for LED: Advantages and Handling Precautions* for more information.

- Do not poke sharp objects into the silicone encapsulant. Sharp object like tweezers or syringes might apply excessive force or even pierce through the silicone and induce failures to the LED die or wire bond.
- Do not touch the silicone encapsulant. Uncontrolled force acting on the silicone encapsulant might result in excessive stress on the wire bond. The LED should only be held by the body.
- Do not stack assembled PCBs together. Use an appropriate rack to hold the PCBs.
- Surface of silicone material attracts dust and dirt easier than epoxy due to its surface tackiness. To remove foreign particles on the surface of silicone, a cotton bud can be used with isopropyl alcohol (IPA). During cleaning, rub the surface gently without putting much pressure on the silicone. Ultrasonic cleaning is not recommended.
- For automated pick and place, Avago has tested nozzle size below to be working fine with this LED. However, due to the possibility of variations in other parameters such as pick and place machine maker/model and other settings of the machine, customer is recommended to verify the nozzle selected will not cause damage to the LED.

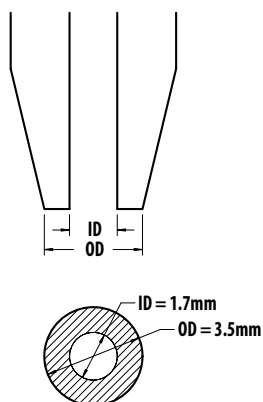

### 2. Handling of moisture sensitive device

This product has a Moisture Sensitive Level 3 rating per JEDEC J-STD-020. Refer to Avago Application Note AN5305, *Handling of Moisture Sensitive Surface Mount Devices*, for additional details and a review of proper handling procedures.

- Before use
  - An unopened moisture barrier bag (MBB) can be stored at  $< 40\text{ }^{\circ}\text{C} / 90\% \text{ RH}$  for 12 months. If the actual shelf life has exceeded 12 months and the humidity indicator card (HIC) indicates that baking is not required, then it is safe to reflow the LEDs per the original MSL rating.
  - It is recommended that the MBB not be opened prior to assembly (e.g., for IQC).
- Control after opening the MBB
  - The humidity indicator card (HIC) shall be read immediately upon opening of MBB.
  - The LEDs must be kept at  $< 30\text{ }^{\circ}\text{C} / 60\% \text{ RH}$  at all times and all high temperature related processes including soldering, curing or rework need to be completed within 168 hours.
- Control for unfinished reel
  - Unused LEDs must be stored in a sealed MBB with desiccant or desiccator at  $< 5\% \text{ RH}$ .
- Control of assembled boards
  - If the PCB soldered with the LEDs is to be subjected to other high temperature processes, the PCB must be stored in a sealed MBB with desiccant or desiccator at  $< 5\% \text{ RH}$  to ensure that all LEDs have not exceeded their floor life of 168 hours.
- Baking is required if:
  - The HIC indicator is not BROWN at 10% and is AZURE at 5%.
  - The LEDs are exposed to condition of  $> 30\text{ }^{\circ}\text{C} / 60\% \text{ RH}$  at any time.
  - The LED floor life exceeded 168 hrs.

The recommended baking condition is:  $60\text{ }^{\circ}\text{C} \pm 5\text{ }^{\circ}\text{C}$  for 20 hrs.

Baking should only be done once.
- Storage
  - The soldering terminals of these Avago LEDs are silver plated. If the LEDs are exposed in ambient environment for too long, the silver plating might be oxidized and thus affect its solderability performance. As such, unused LEDs must be kept in a sealed MBB with desiccant or in desiccator at  $< 5\% \text{ RH}$ .

### 3. Application precautions

- a. Drive current of the LED must not exceed the maximum allowable limit across temperature as stated in the data sheet. Constant current driving is recommended to ensure consistent performance.
- b. LEDs do exhibit slightly different characteristics at different drive currents that might result in larger variation their performance (i.e., intensity, wavelength and forward voltage). User is recommended to set the application current as close as possible to the test current in order to minimize these variations.
- c. LED is not intended for reverse bias. Do use other appropriate components for such purpose. When driving the LED in matrix form, it is crucial to ensure that the reverse bias voltage is not exceeding the allowable limit of the LED.
- d. Do not use the LED in the vicinity of material with sulfur content, in environment of high gaseous sulfur compound and corrosive elements. Examples of material that may contain sulfur are rubber gasket, RTV (room temperature vulcanizing) silicone rubber, rubber gloves, etc. Prolonged exposure to such environment may affect the optical characteristics and product life.
- e. Avoid rapid change in ambient temperature especially in high humidity environment as this will cause condensation on the LED.
- f. Although the LED is rated as IPx6 according to IEC60529: Degree of protection provided by enclosure, the test condition may not represent actual exposure during application. If the LED is intended to be used in outdoor or harsh environment, the LED must be protected against damages caused by rain water, dust, oil, corrosive gases, external mechanical stress, etc.

### 4. Thermal management

Optical, electrical, and reliability characteristics of the LED are affected by temperature. The junction temperature ( $T_J$ ) of the LED must be kept below allowable limit at all times.  $T_J$  can be calculated as below:

$$T_J = T_A + R_{\theta J-A} \times I_F \times V_{Fmax}$$

where;

$T_A$  = ambient temperature (°C)

$R_{\theta J-A}$  = thermal resistance from LED junction to ambient (°C/W)

$I_F$  = forward current (A)

$V_{Fmax}$  = maximum forward voltage (V)

The complication of using this formula lies in  $T_A$  and  $R_{\theta J-A}$ . Actual  $T_A$  is sometimes subjective and hard to determine.  $R_{\theta J-A}$  varies from system to system depending on design and is usually not known.

Another way of calculating  $T_J$  is by using solder point temperature  $T_S$  as shown below:

$$T_J = T_S + R_{\theta J-S} \times I_F \times V_{Fmax}$$

where;

$T_S$  = LED solder point temperature as shown in the following illustration (°C)

$R_{\theta J-S}$  = thermal resistance from junction to solder point (°C/W)

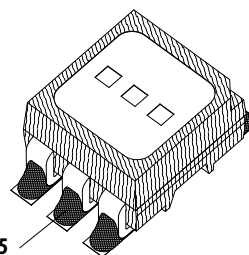

$T_S$  can be measured easily by mounting a thermocouple on the soldering joint as shown in preceding illustration, while  $R_{\theta J-S}$  is provided in the data sheet. The user is advised to verify the  $T_S$  of the LED in the final product to ensure that the LEDs are operated within all maximum ratings stated in the data sheet.

### 5. Eye safety precautions

LEDs may pose optical hazards when in operation. It is not advisable to view directly at operating LEDs as it may be harmful to the eyes. For safety reasons, use appropriate shielding or personal protective equipment.

### 6. Disclaimer

Avago's products are not specifically designed, manufactured, or authorized for sale as parts, components or assemblies for the planning, construction, maintenance, or direct operation of a nuclear facility or for use in medical devices or applications. Customer is solely responsible, and waives all rights to make claims against Avago or its suppliers, for all loss, damage, expense, or liability in connection with such use.

---

For product information and a complete list of distributors, please go to our web site:

[www.avagotech.com](http://www.avagotech.com)

Avago Technologies and the A logo are trademarks of Avago Technologies in the United States and other countries. All other brand and product names may be trademarks of their respective companies.

Data subject to change. Copyright © 2015–2016 Avago Technologies. All Rights Reserved.

AV02-2589EN – April 15, 2016

**AVAGO**  
TECHNOLOGIES



Lead (Pb) Free  
RoHS 6 fully  
compliant