



Chipsmall Limited consists of a professional team with an average of over 10 year of expertise in the distribution of electronic components. Based in Hongkong, we have already established firm and mutual-benefit business relationships with customers from,Europe,America and south Asia,supplying obsolete and hard-to-find components to meet their specific needs.

With the principle of "Quality Parts,Customers Priority,Honest Operation,and Considerate Service",our business mainly focus on the distribution of electronic components. Line cards we deal with include Microchip,ALPS,ROHM,Xilinx,Pulse,ON,Everlight and Freescale. Main products comprise IC,Modules,Potentiometer,IC Socket,Relay,Connector.Our parts cover such applications as commercial,industrial, and automotives areas.

We are looking forward to setting up business relationship with you and hope to provide you with the best service and solution. Let us make a better world for our industry!



## Contact us

Tel: +86-755-8981 8866 Fax: +86-755-8427 6832

Email & Skype: info@chipsmall.com Web: www.chipsmall.com

Address: A1208, Overseas Decoration Building, #122 Zhenhua RD., Futian, Shenzhen, China



# SMD SHIELDED INDUCTOR

ASPI-0403S



**RoHS**  
Compliant



6.6 x 4.45 x 2.92 mm

## FEATURES:

- Low DCR
- High reliability
- Magnetically shielded
- High energy storage capacity
- High heat resistance, ideal for reflow soldering

## APPLICATIONS:

- PDAs and Pagers
- Mobile phone
- Notebook
- Battery Charger
- Flash memory programmer
- Entertainment electronic devices

## STANDARD SPECIFICATIONS:

### PARAMETERS

ABRACON P/N:	ASPI-0403S-xxx Series
Operating temperature:	-40°C to + 85°C
Storage temperature:	-40°C to + 85°C

Part#	Inductance (μH)	Tol. (%)	RDC (Ω)	IDC (A)
ASPI-0403S-1R0M	1.0	M	0.040	3.00
ASPI-0403S-1R5M	1.5	M	0.045	2.80
ASPI-0403S-1R8M	1.8	M	0.048	2.30
ASPI-0403S-2R2M	2.2	M	0.050	1.80
ASPI-0403S-3R3M	3.3	M	0.055	1.60
ASPI-0403S-4R7M	4.7	M	0.060	1.40
ASPI-0403S-5R6M	5.6	M	0.062	1.30
ASPI-0403S-6R8M	6.8	M	0.065	1.20
ASPI-0403S-100M	10	M	0.075	1.00
ASPI-0403S-150M	15	M	0.090	0.80
ASPI-0403S-220M	22	M	0.110	0.70
ASPI-0403S-330M	33	M	0.190	0.60
ASPI-0403S-470M	47	M	0.230	0.50
ASPI-0403S-680M	68	M	0.290	0.40
ASPI-0403S-101M	100	M	0.480	0.30
ASPI-0403S-151M	150	M	0.590	0.26
ASPI-0403S-221M	220	M	0.770	0.22
ASPI-0403S-331M	330	M	1.400	0.20
ASPI-0403S-471M	470	M	1.800	0.19
ASPI-0403S-681M	680	M	2.200	0.18
ASPI-0403S-102M	1000	M	3.400	0.15
ASPI-0403S-152M	1500	M	4.200	0.12
ASPI-0403S-222M	2200	M	8.500	0.10
ASPI-0403S-332M	3300	M	11.000	0.08
ASPI-0403S-472M	4700	M	13.900	0.06
ASPI-0403S-682M	6800	M	25.000	0.04
ASPI-0403S-822M	8200	M	29.810	0.03
ASPI-0403S-103M	10000	M	32.800	0.02

Test Frequency is 100KHz. DCR & IDC listed are all Max. value. Tolerance: M=±20%, M tolerance is standard

## PART IDENTIFICATIONS:

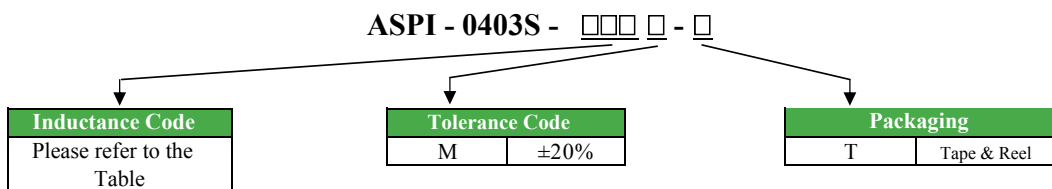

ABRACON IS  
ISO 9001:2008  
CERTIFIED



**ABRACON**  
CORPORATION

Visit [www.abracon.com](http://www.abracon.com) for Terms & Conditions of Sale

30332 Esperanza, Rancho Santa Margarita, California 92688  
tel 949-546-8000 | fax 949-546-8001 | [www.abracon.com](http://www.abracon.com)

**Revised: 07.08.14**

# SMD SHIELDED INDUCTOR

ASPI-0403S

**Pb** RoHS  
Compliant



6.6 x 4.45 x 2.92 mm

## INDUCTANCE VS CURRENT

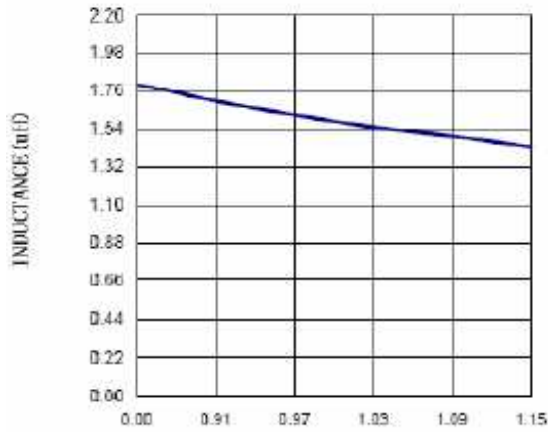

1R8M  
CURRENT (A)

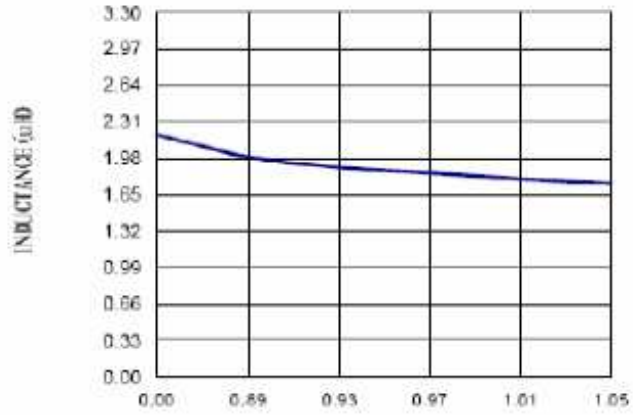

2R2M  
CURRENT (A)

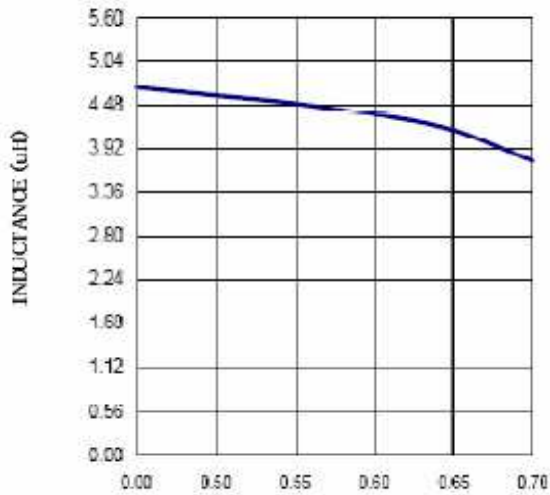

4R7M  
CURRENT (A)

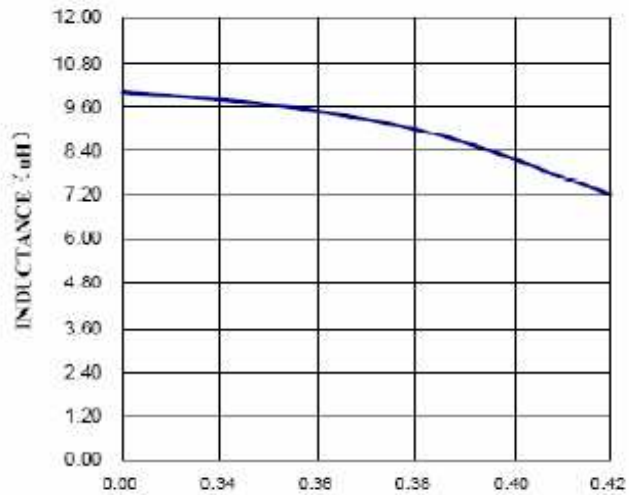

100M  
CURRENT (A)

# SMD SHIELDED INDUCTOR

ASPI-0403S



6.6 x 4.45 x 2.92 mm

## INDUCTANCE VS CURRENT

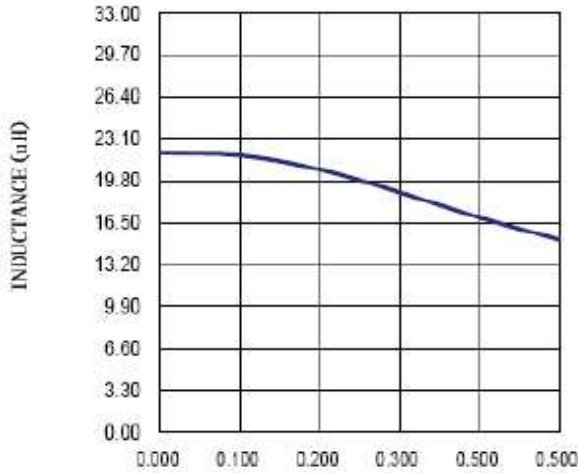

220M  
CURRENT (A)

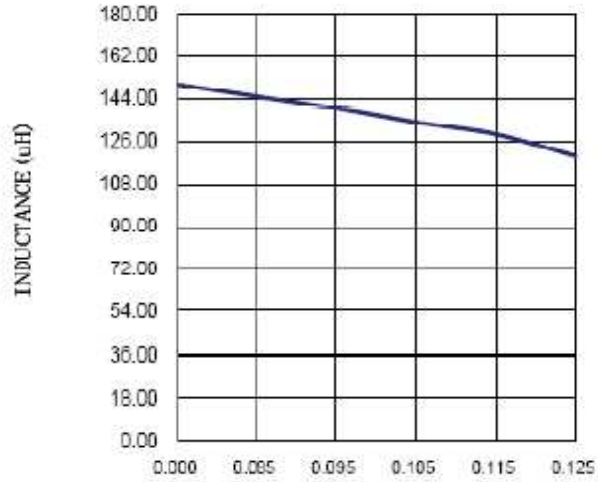

151M  
CURRENT (A)

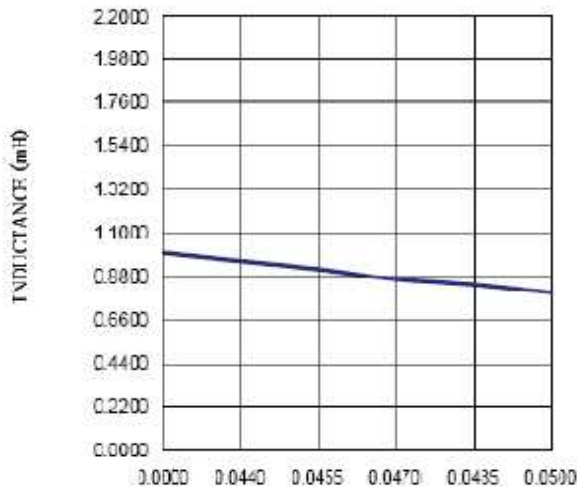

102M  
CURRENT (A)

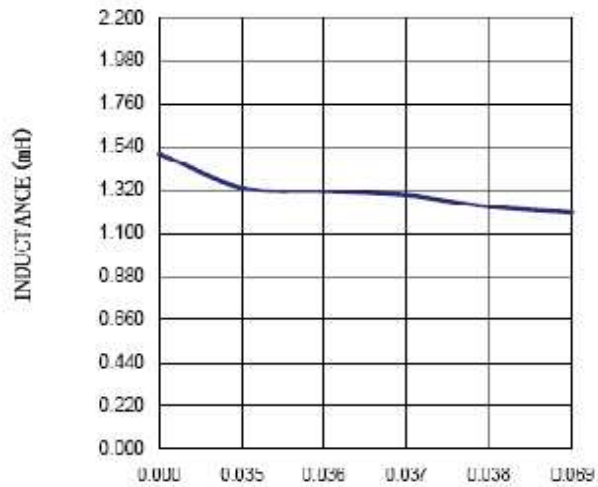

152M  
CURRENT (A)

# SMD SHIELDED INDUCTOR

ASPI-0403S



6.6 x 4.45 x 2.92 mm

## OUTLINE DIMENSION:

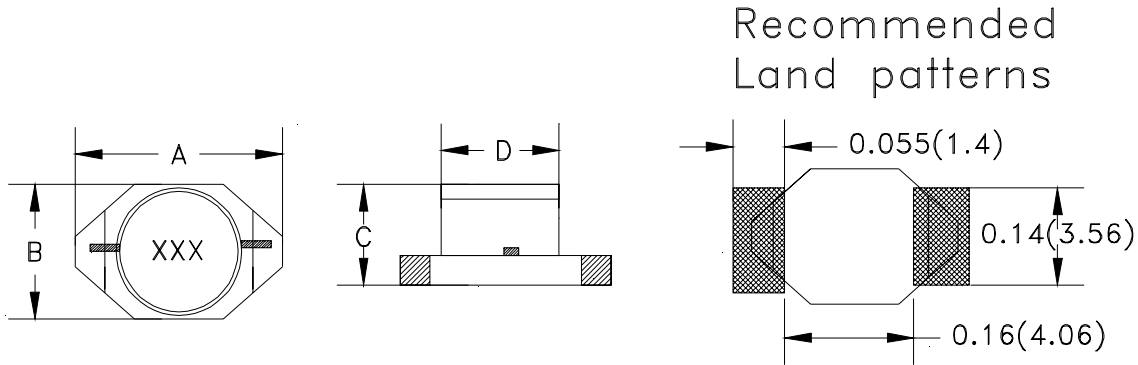

Part	A	B	C	D
ASPI-0403S-xxx	0.260 Max (6.60) Max	0.175 Max (4.45) Max	0.115 Max (2.92) Max	0.157±0.012 (4.0±0.3)

Dimensions: Inches (mm)

## REFLOW PROFILE:

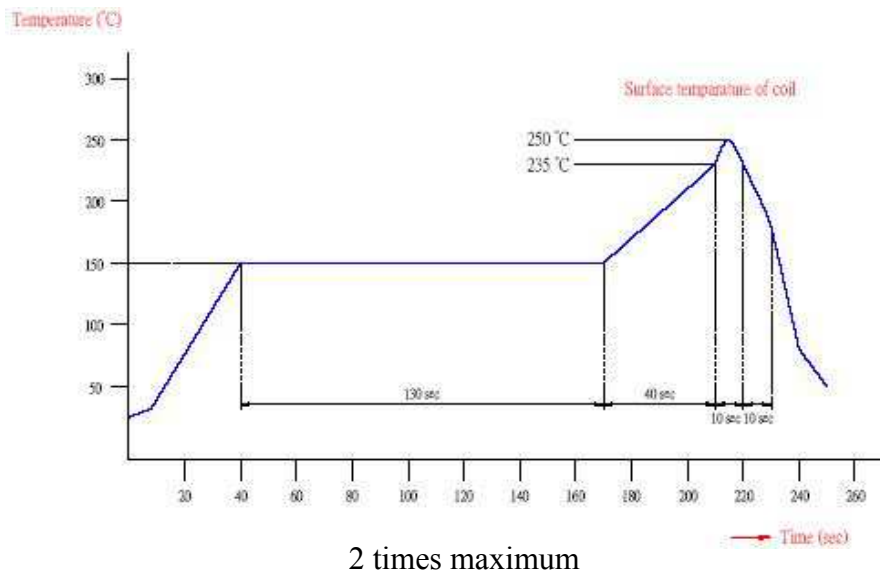

# SMD SHIELDED INDUCTOR

ASPI-0403S



RoHS  
Compliant



6.6 x 4.45 x 2.92 mm

## TAPE & REEL:

T= tape and reel (2,500 pcs per reel)

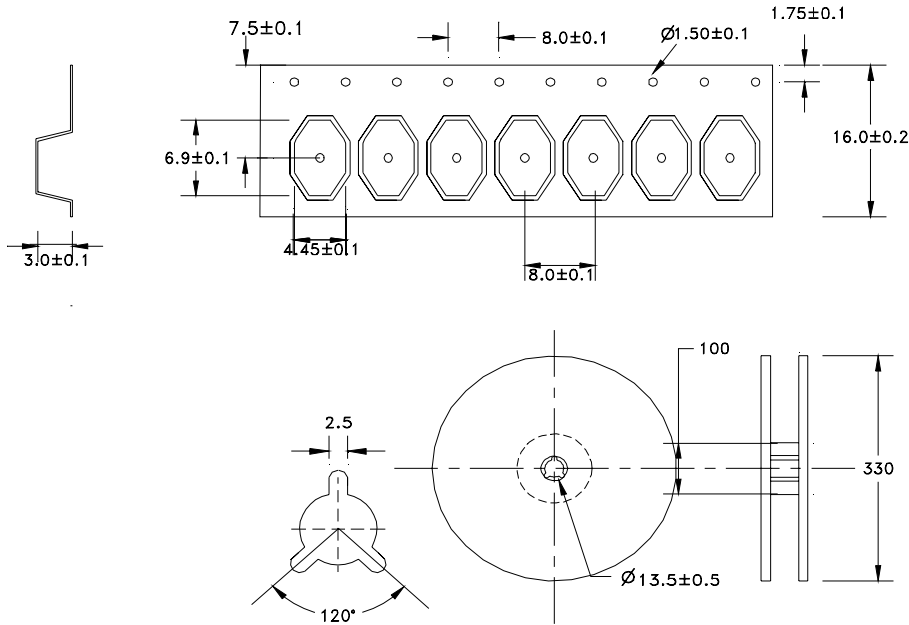

**ATTENTION:** Abracon Corporation's products are COTS – Commercial-Off-The-Shelf products; suitable for Commercial, Industrial and, where designated, Automotive Applications. Abracon's products are not specifically designed for Military, Aviation, Aerospace, Life-dependant Medical applications or any application requiring high reliability where component failure could result in loss of life and/or property. For applications requiring high reliability and/or presenting an extreme operating environment, written consent and authorization from Abracon Corporation is required. Please contact Abracon Corporation for more information.

ABRACON IS  
ISO 9001:2008  
CERTIFIED



Visit [www.abracon.com](http://www.abracon.com) for Terms & Conditions of Sale **Revised: 07.08.14**  
30332 Esperanza, Rancho Santa Margarita, California 92688  
tel 949-546-8000 | fax 949-546-8001 | [www.abracon.com](http://www.abracon.com)