



Chipsmall Limited consists of a professional team with an average of over 10 year of expertise in the distribution of electronic components. Based in Hongkong, we have already established firm and mutual-benefit business relationships with customers from,Europe,America and south Asia,supplying obsolete and hard-to-find components to meet their specific needs.

With the principle of "Quality Parts,Customers Priority,Honest Operation,and Considerate Service",our business mainly focus on the distribution of electronic components. Line cards we deal with include Microchip,ALPS,ROHM,Xilinx,Pulse,ON,Everlight and Freescale. Main products comprise IC,Modules,Potentiometer,IC Socket,Relay,Connector.Our parts cover such applications as commercial,industrial, and automotives areas.

We are looking forward to setting up business relationship with you and hope to provide you with the best service and solution. Let us make a better world for our industry!



## Contact us

Tel: +86-755-8981 8866 Fax: +86-755-8427 6832

Email & Skype: info@chipsmall.com Web: www.chipsmall.com

Address: A1208, Overseas Decoration Building, #122 Zhenhua RD., Futian, Shenzhen, China



# Precision SMD TCXO/VCTCXO

AST3TQ-50



ESD Sensitive



RoHS/RoHS II Compliant

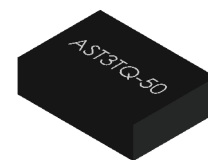

7.0 x 5.0 x 1.9mm

Moisture Sensitivity Level (MSL) – 3

## FEATURES:

- Standard available frequencies: 10.00, 12.80, 16.384, 19.20, 19.44, 20.00, 24.576, 25.00, 26.00, 30.72, 40.00 MHz
- LVC MOS Output or Clipped Sine Wave output
- Frequency stability:  $\pm 50$ ppb over  $-40^{\circ}\text{C}$  to  $+85^{\circ}\text{C}$  operating temperature range
- Excellent Phase Noise, Harmonics and Spurious content
- Typical rms jitter of 400fs @ 40MHz carrier & 1.0ps @ 10MHz carrier over 12kHz to 20MHz BW

## APPLICATIONS:

- COTS Military Radios & other Communication Hardware
- WiMax,
- LTE, BTS
- CATV, LAN, LMDS
- GPS Tracking with Hold-Over accuracy
- Test & Measurement Equipment
- Point-to-Point communication networks

## STANDARD SPECIFICATIONS:

### Maximum Rating

Parameters	Rating
Storage Temperature Range	$-55$ to $+125^{\circ}\text{C}$
Supply Voltage	$-0.5$ to $6\text{V}$
Control Voltage	$0$ to $3\text{V}$
ESD, HBM/CDM/MM	$4\text{kV}/2\text{kV}/200\text{V}$

### Key Electrical Specifications

Parameters	Minimum	Typical	Maximum	Units	Notes
Frequency Range	10		40	MHz	
Standard Frequencies	10.00, 12.80, 16.384, 19.20, 19.44, 20.00, 24.576, 25.00, 26.00, 30.72, 40.00			MHz	
Initial Frequency Tolerance (@ $+25^{\circ}\text{C}$ ) at shipping			$\pm 500$	ppb	Relative to carrier
<b>Frequency Stability Options</b>					
$-40^{\circ}\text{C}$ to $+85^{\circ}\text{C}$			$\pm 50$	ppb	
Frequency Stability vs. Supply Voltage Change ( $V_{\text{dd}}\pm 5\%$ )			$\pm 100$	ppb	
Frequency Stability vs. Load Change ( $\text{Load}\pm 5\%$ )			$\pm 200$	ppb	
Aging (first year @ $+25^{\circ}\text{C}$ )			$\pm 1.0$	ppm	
Aging (20 years @ $+25^{\circ}\text{C}$ )		$\pm 3.0$	$\pm 4.6$	ppm	
Supply Voltage ( $V_{\text{dd}}$ )	$+3.135$	$+3.3$	$+3.465$	V	
Supply Current ( $I_{\text{cc}}$ )		3.0	4.0	mA	@10MHz carrier
			5.5		7.0
<b>Control Port (Applicable for VCTCXO only)</b>					
Control Voltage Range ( $V_{\text{c}}$ )	$+0.5$	$+1.5$	$+2.5$	V	
Center Control Voltage ( $V_{\text{c}}$ )		$+1.5$		V	To be with-in $\pm 500$ ppb of $F_{\text{c}}$ @ $25^{\circ}\text{C}$ (at shipping)
Frequency Tuning Range	$\pm 5.00$	$\pm 7.00$	$<\pm 13.00$	ppm	( $V_{\text{c}} = 1.5\text{V}\pm 1.0\text{V}$ )
Tuning Slope	Positive				
Linearity			$\pm 1$	%	
Port Impedance	100			$\text{k}\Omega$	

# Precision SMD TCXO/VCTCXO

AST3TQ-50



ESD Sensitive



RoHS/RoHS II Compliant



7.0 x 5.0 x 1.9mm

## STANDARD SPECIFICATIONS:

(Continued)

Parameters	Minimum	Typical	Maximum	Unites	Notes
Phase Noise (10MHz carrier frequency @25°C):			-95	dBc/Hz	Offset @10Hz
			-120		Offset @100Hz
			-140		Offset @1kHz
			-145		Offset @10kHz
			-150		Offset @100kHz
RMS Jitter (@12kHz~5MHz BW)	0.4		1.3	ps	Carrier Dependent
<b>Clipped Sine Wave</b>					
Output Level	0.8			Vp-p	
Output Load	10kΩ//10pF				
<b>LVC MOS Output (Square Wave)</b>					
V <sub>OH</sub>	2.4			V	Output Load=15pF
V <sub>OL</sub>			0.4	V	Output Load=15pF
Output Load			15	pF	
Duty Cycle	45		55	%	@(V <sub>OH</sub> - V <sub>OL</sub> )/2
Rise/Fall Time			6	ns	Output Load=15pF

## PART IDENTIFICATION:

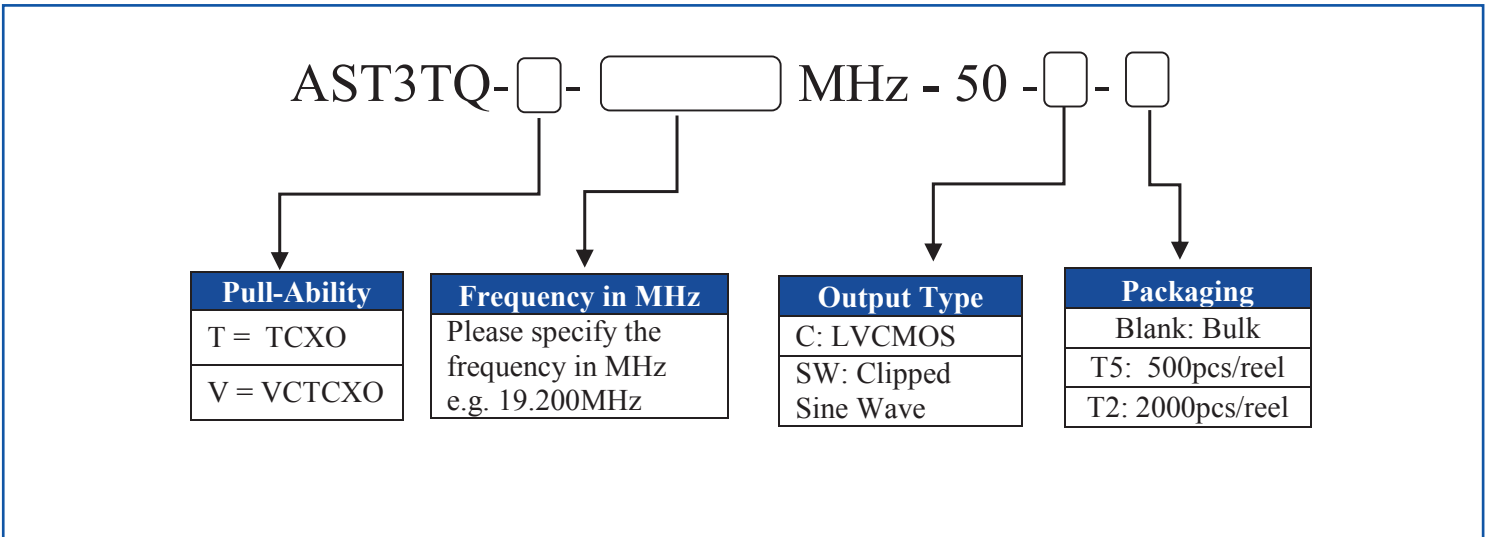



## TYPICAL FREQUENCY STABILITY VS. TEMPERATURE

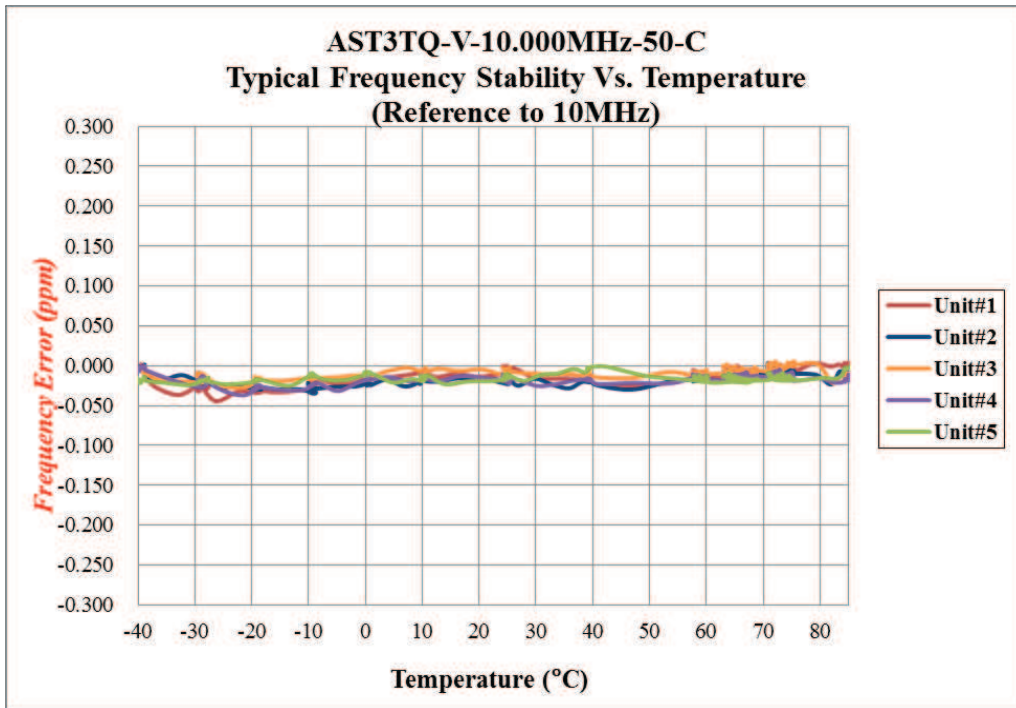

## TYPICAL SHORT TERM STABILITY

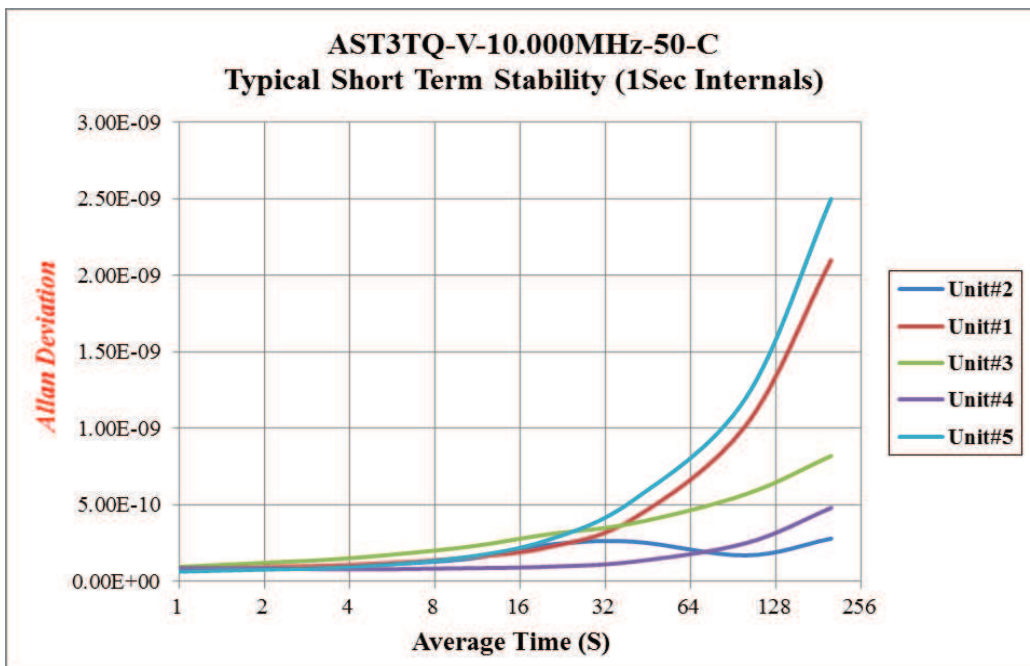

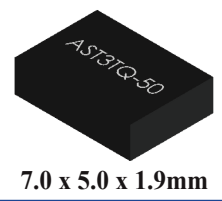

AST3TQ-50



ESD Sensitive



RoHS/RoHS II Compliant

7.0 x 5.0 x 1.9mm

## TYPICAL FREQUENCY PULL VS. CONTROL VOLTAGE

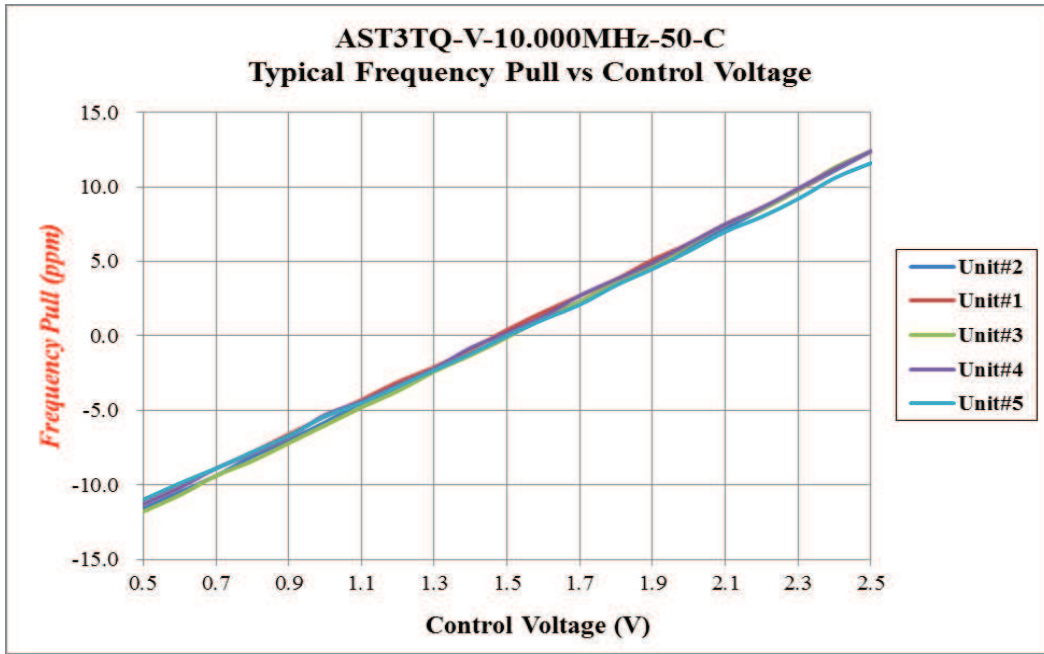

## TYPICAL PHASE NOISE

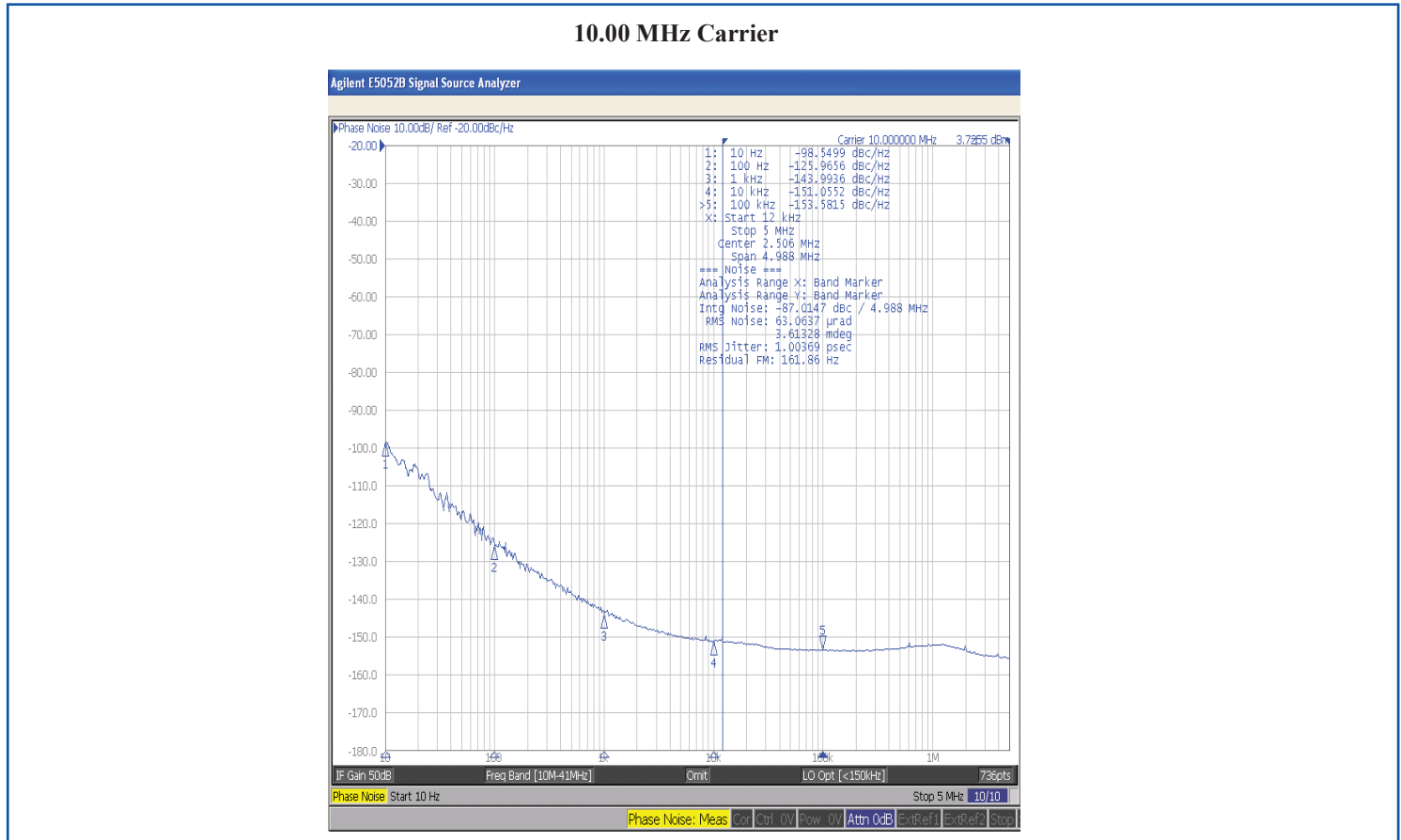

# Precision SMD TCXO/VCTCXO

AST3TQ-50



ESD Sensitive



RoHS/RoHS II Compliant



7.0 x 5.0 x 1.9mm

## TYPICAL AGING:

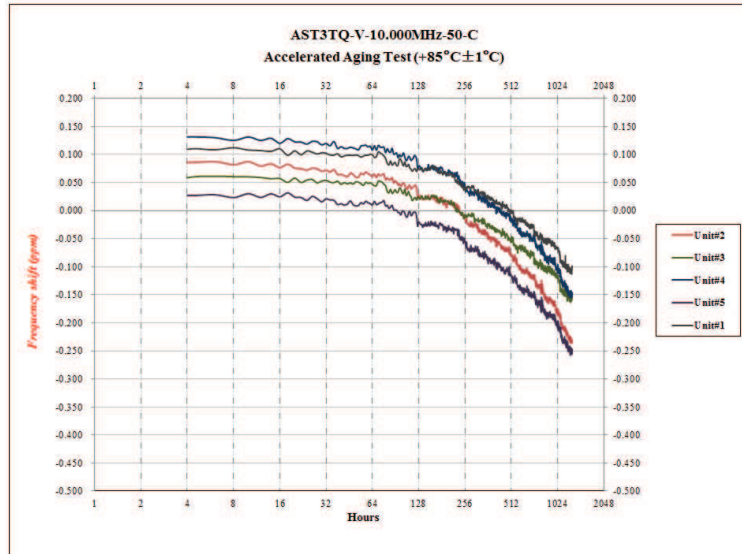

Aging Test Conditions	
Series	AST3TQ-50
Frequency	10MHz
Acquisition Mode	Cycle
Acquisition Time	1129 hours
Test Temperature	+85°C ± 1°C
Number of Samples	5pcs

Aging Data			
No.	Aging Time (hrs)	Aging/Day (ppm)	Projected Aging/year (ppm)
#1	1129	-0.0039	-0.3896
#2	1129	-0.0059	-0.5925
#3	1129	-0.0042	-0.4202
#4	1129	-0.0056	-0.5555
#5	1129	-0.0055	-0.5492

## OUTLINE DIMENSION:

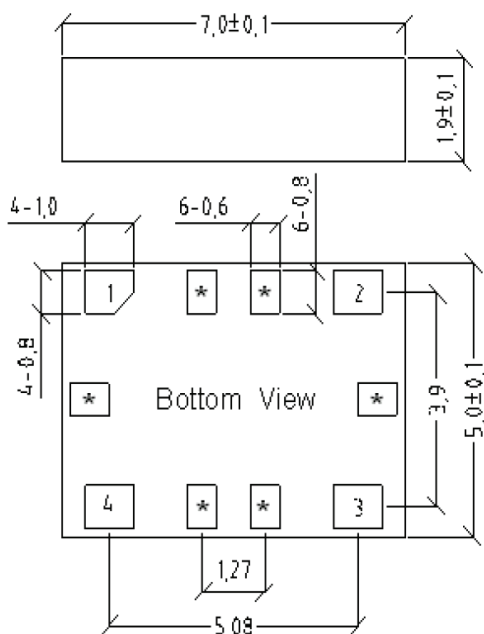

Dimensions: mm

## Recommended Land Pattern

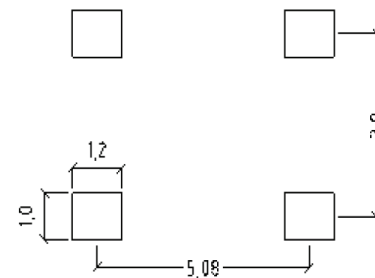

Pin	Function
1	NC (for TCXO) Vc (for VCTCXO)
2	GND
3	Output
4	Vdd
*	For factory test only

ABRACON IS  
ISO9001:2008  
CERTIFIED



2 Faraday, Suite# B | Irvine | CA 92618 Revised: 04.02.15

Ph. 949.546.8000 | Fax. 949.546.8001

Visit [www.abracon.com](http://www.abracon.com) for Terms and Conditions of Sale

# Precision SMD TCXO/VCTCXO

AST3TQ-50



ESD Sensitive



RoHS/RoHS II Compliant

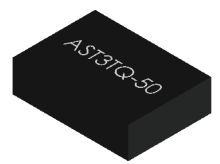

7.0 x 5.0 x 1.9mm

## REFLOW PROFILE:

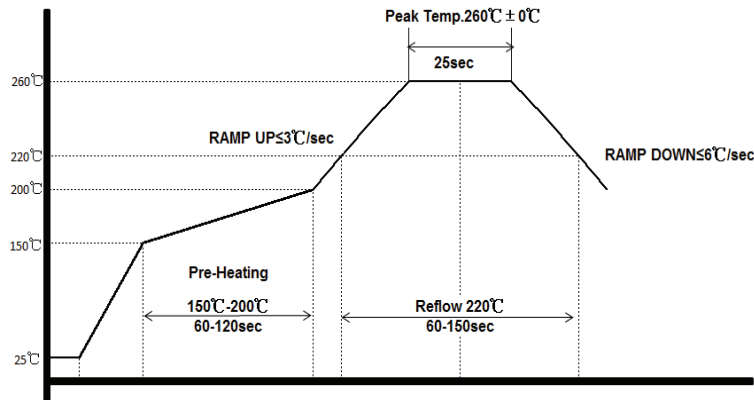

## TAPE & REEL:

### Packaging:

T5: 500pcs/reel

T2: 2,000pcs/reel

**MSL-3 packaging applies to MOQ=25 units (cut tape) & T5 and T2.**

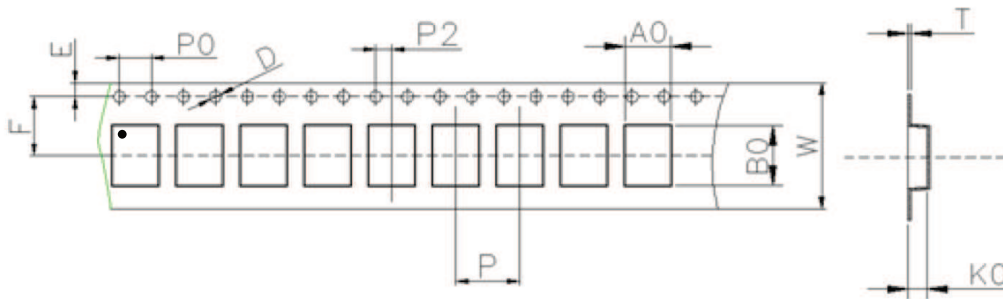

W	A0	B0	K0	P	F
16.0±0.3	5.7±0.15	7.6±0.15	2.4±0.15	8.0±0.1	7.5±0.1
E	D	P0	P2	T	
1.75±0.1	1.5+0.1/-0.0	4.0±0.1	2.0±0.1	0.3±0.05	

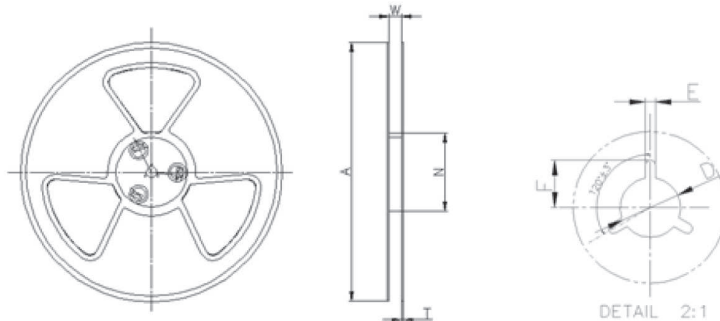

Dimensions: mm

W	A	N	T	E	F	D
16.5±0.4	330±0.5	100±0.3	1.8±0.2	2.1±0.3	10.75±0.3	13.5+0.5/-0.2

**ATTENTION:** Abracon Corporation's products are COTS – Commercial-Off-The-Shelf products; suitable for Commercial, Industrial and, where designated, Automotive Applications. Abracon's products are not specifically designed for Military, Aviation, Aerospace, Life-dependant Medical applications or any application requiring high reliability where component failure could result in loss of life and/or property. For applications requiring high reliability and/or presenting an extreme operating environment, written consent and authorization from Abracon Corporation is required. Please contact Abracon Corporation for more information.

ABRACON IS  
ISO9001:2008  
CERTIFIED



2 Faraday, Suite# B | Irvine | CA 92618 **Revised: 04.02.15**

Ph. 949.546.8000 | Fax. 949.546.8001

Visit [www.abracon.com](http://www.abracon.com) for Terms and Conditions of Sale