



Chipsmall Limited consists of a professional team with an average of over 10 year of expertise in the distribution of electronic components. Based in Hongkong, we have already established firm and mutual-benefit business relationships with customers from,Europe,America and south Asia,supplying obsolete and hard-to-find components to meet their specific needs.

With the principle of “Quality Parts,Customers Priority,Honest Operation,and Considerate Service”,our business mainly focus on the distribution of electronic components. Line cards we deal with include Microchip,ALPS,ROHM,Xilinx,Pulse,ON,Everlight and Freescale. Main products comprise IC,Modules,Potentiometer,IC Socket,Relay,Connector.Our parts cover such applications as commercial,industrial, and automotives areas.

We are looking forward to setting up business relationship with you and hope to provide you with the best service and solution. Let us make a better world for our industry!



Contact us

Tel: +86-755-8981 8866 Fax: +86-755-8427 6832

Email & Skype: info@chipsmall.com Web: www.chipsmall.com

Address: A1208, Overseas Decoration Building, #122 Zhenhua RD., Futian, Shenzhen, China



4		3		2		1	
ITEM	CONNECTOR PART NO.	DESCRIPTION	IPI CHECK	EOR CHECK	Applicable Tooling		
1	SVM-61T-P2.0	VL CONNECTOR - MALE CONTACT			APPLICATOR		
2	UL1015, 14 AWG	BLACK			Applicable Housings		

NO. OF CIRCUITS	HOUSING PART NO. WITH PANEL LOCKS	HOUSING PART NO. WITHOUT PANEL LOCKS
1	-	VLR-01VF
2	VLR-02V	VLR-02VF
3	VLR-03V	-
4	VLR-04V	VLR-04VF
4	VLR-04VN	-
6	VLR-06V	-
8	VLR-08V	-
12	VLR-12V	-

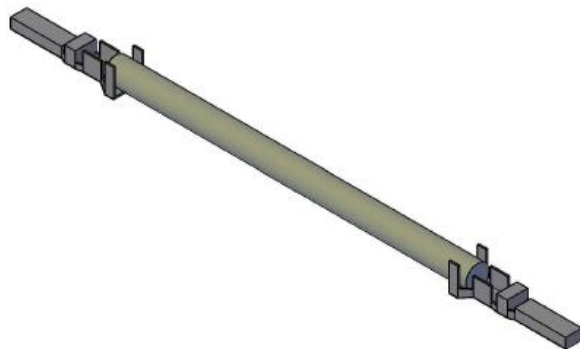
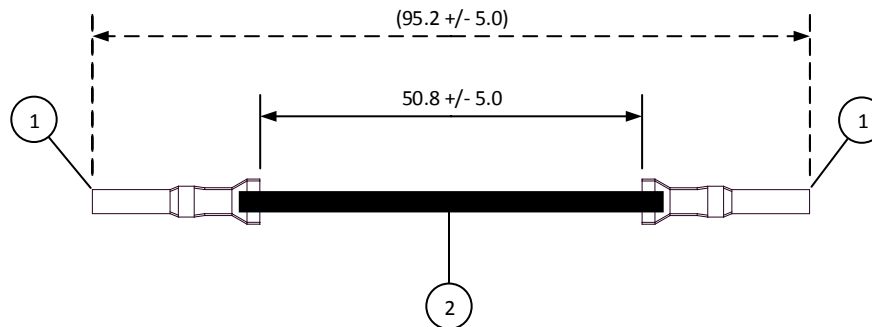

JST

SCALE	CUSTOMER NAME	CUSTOMER PART NO.
1:1		
DIMENSIONS	DESCRIPTION	
All dimensions are in MM with a tolerance of +/- 3.0 unless otherwise specified.	6.2 mm Pitch VL Series Standard Leads - 2" Inside Length DOUBLE-END LEADS, M-M	
DRAWN BY	ASSEMBLY PART NO.	
STEVEN PILKINGTON	ASVMSVM14K51	
CHECKED BY	DRAWING NO. & REVISION	REVISED
JUSTIN BAKER	GAM-094	3/9/2016

REV.	DESCRIPTION	DATE	BY

4 | 3 | 2 | 1