



Chipsmall Limited consists of a professional team with an average of over 10 year of expertise in the distribution of electronic components. Based in Hongkong, we have already established firm and mutual-benefit business relationships with customers from,Europe,America and south Asia,supplying obsolete and hard-to-find components to meet their specific needs.

With the principle of “Quality Parts,Customers Priority,Honest Operation,and Considerate Service”,our business mainly focus on the distribution of electronic components. Line cards we deal with include Microchip,ALPS,ROHM,Xilinx,Pulse,ON,Everlight and Freescale. Main products comprise IC,Modules,Potentiometer,IC Socket,Relay,Connector.Our parts cover such applications as commercial,industrial, and automotives areas.

We are looking forward to setting up business relationship with you and hope to provide you with the best service and solution. Let us make a better world for our industry!



## Contact us

Tel: +86-755-8981 8866 Fax: +86-755-8427 6832

Email & Skype: info@chipsmall.com Web: www.chipsmall.com

Address: A1208, Overseas Decoration Building, #122 Zhenhua RD., Futian, Shenzhen, China



# AT-41511, AT-41533

## General Purpose, Low Noise NPN Silicon Bipolar Transistors



### Data Sheet



#### Description

Avago's AT-41511 and AT-41533 are general purpose NPN bipolar transistors that offer excellent high frequency performance at an economical price. The AT-41533 uses the 3 lead SOT-23, while the AT-41511 places the same die in the lower parasitic 4 lead SOT-143. Both packages are industry standard, and compatible with high volume surface mount assembly techniques.

The 4 micron emitter-to-emitter pitch of these transistors yields high performance products that can perform a multiplicity of tasks. The 14 emitter finger interdigitated geometry yields an intermediate-sized transistor with easy to match to impedances, low noise figure, and moderate power.

Optimized for best performance from a 5 to 8 volt bias supply, these transistors are also good performers at 2.7 V. Applications include use in wireless systems as an LNA, gain stage, buffer, oscillator, or active mixer.

An optimum noise match near 50 ohms at 900 MHz makes these devices particularly easy to use as LNAs. Typical amplifier designs at 900 MHz yield 1 dB noise figures with 15 dB or more associated gain at a 5 V, 5 mA bias, with good gain and noise figure obtainable at biases as low as 2 mA.

The AT-415 series bipolar transistors are fabricated using Avago's 10 GHz  $f_T$  Self-Aligned-Transistor (SAT) process. The die are nitride passivated for surface protection. Excellent device uniformity, performance and reliability are produced by the use of ion-implantation, self-alignment techniques, and gold metalization in the fabrication of these devices.

#### Features

- General Purpose NPN Bipolar Transistor
- 900 MHz Performance:
  - AT-41511: 1 dB NF, 15.5 dB  $G_A$
  - AT-41533: 1 dB NF, 14.5 dB  $G_A$
- Characterized for 3, 5, and 8 Volt Use
- SOT-23 and SOT-143 SMT Plastic Packages
- Tape-and-Reel Packaging Option Available
- Lead-free

#### Pin Connections and Package Marking

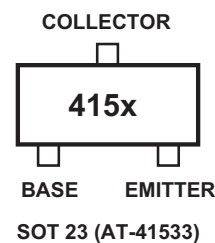
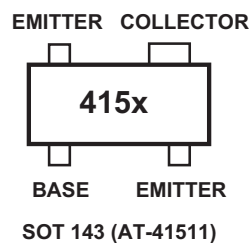

#### Notes:

Top View. Package Marking provides orientation and identification. "x" is the date code.

## AT-41511, AT-41533 Absolute Maximum Ratings

Symbol	Parameter	Units	Absolute Maximum <sup>[1]</sup>
V <sub>EBO</sub>	Emitter-Base Voltage	V	1.5
V <sub>CBO</sub>	Collector-Base Voltage	V	20
V <sub>CEO</sub>	Collector-Emitter Voltage	V	12
I <sub>C</sub>	Collector Current	mA	50
P <sub>T</sub>	Power Dissipation <sup>[2,3]</sup>	mW	225
T <sub>j</sub>	Junction Temperature	°C	150
T <sub>STG</sub>	Storage Temperature	°C	-65 to 150

### Thermal Resistance:<sup>[2]</sup>

$$\theta_{jc} = 550^{\circ}\text{C}/\text{W}$$

#### Notes:

1. Operation of this device above any one of these parameters may cause permanent damage.

2. T<sub>Mounting Surface</sub> = 25°C.

3. Derate at 1.82 mW/°C for T<sub>C</sub> > 26°C.

## Electrical Specifications, T<sub>A</sub> = 25°C

Symbol	Parameters and Test Conditions	Units	AT-41511			AT-41533		
			Min	Typ	Max	Min	Typ	Max
h <sub>FE</sub>	Forward Current Transfer Ratio V <sub>CE</sub> = 5 V, I <sub>C</sub> = 5 mA	-	30	150	270	30	150	270
I <sub>CBO</sub>	Collector Cutoff Current	μA			0.2			0.2
I <sub>EBO</sub>	Emitter Cutoff Current	μA			1.0			1.0

## Characterization Information, T<sub>A</sub> = 25°C

Symbol	Parameters and Test Conditions	Units	AT-41511		AT-41533	
			Min	Typ	Min	Typ
NF	Noise Figure V <sub>CE</sub> = 5 V, I <sub>C</sub> = 5 mA	f = 0.9 GHz		1.0	1.0	
		f = 2.4 GHz		1.7	1.6	
G <sub>A</sub>	Associated Gain V <sub>CE</sub> = 5 V, I <sub>C</sub> = 5 mA	f = 0.9 GHz		15.5	14.5	
		f = 2.4 GHz		11	9	
P <sub>1dB</sub>	Power at 1 dB Gain Compression (opt tuning) V <sub>CE</sub> = 5 V, I <sub>C</sub> = 25 mA	f = 0.9 GHz		14.5	14.5	
G <sub>1dB</sub>	Gain at 1 dB Gain Compression (opt tuning) V <sub>CE</sub> = 5 V, I <sub>C</sub> = 25 mA	f = 0.9 GHz		17.5	14.5	
IP <sub>3</sub>	Output Third Order Intercept Point, V <sub>CE</sub> = 5 V, I <sub>C</sub> = 25 mA (opt tuning)	f = 0.9 GHz		25	25	
S <sub>21E</sub>   <sup>2</sup>	Gain in 50 Ω system; V <sub>CE</sub> = 5 V, I <sub>C</sub> = 5 mA	f = 0.9 GHz	13.5	15.5	10.8	12.8
		f = 2.4 GHz		7.9		5.2

## AT-41511, AT-41533 Typical Performance

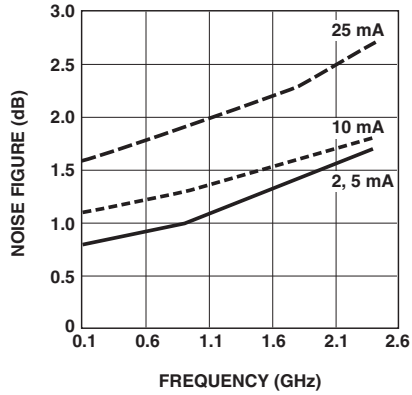

Figure 1. AT-41511 and AT-41533 Minimum Noise Figure vs. Frequency and Current at  $V_{CE} = 2.7$  V.

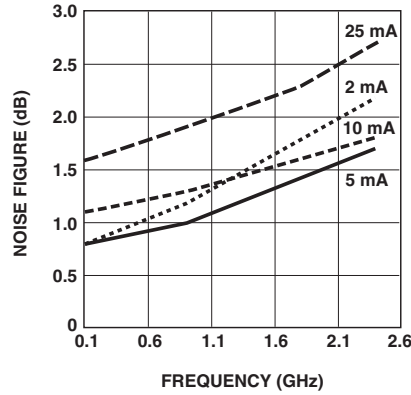

Figure 2. AT-41511 and AT-41533 Minimum Noise Figure vs. Frequency and Current at  $V_{CE} = 5$  V.

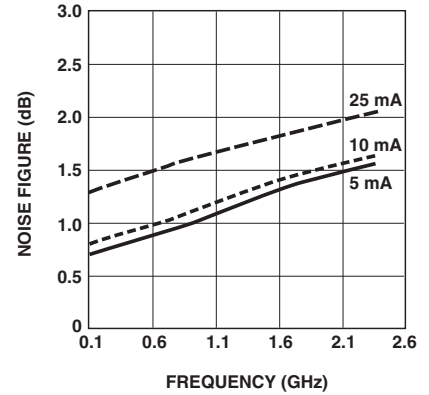

Figure 3. AT-41511 and AT-41533 Minimum Noise Figure vs. Frequency and Current at  $V_{CE} = 8$  V.

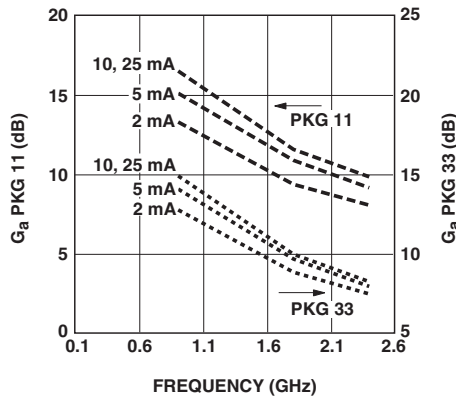

Figure 4. AT-41511 and AT-41533 Associated Gain vs. Frequency and Current at  $V_{CE} = 2.7$  V.

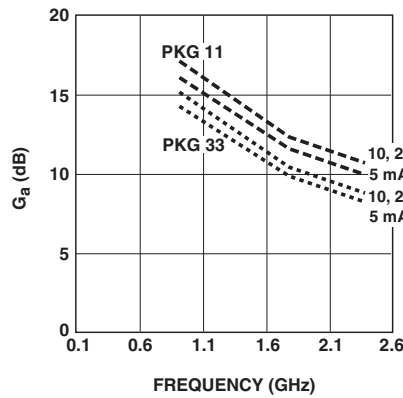

Figure 5. AT-41511 and AT-41533 Associated Gain vs. Frequency and Current at  $V_{CE} = 5$  V.

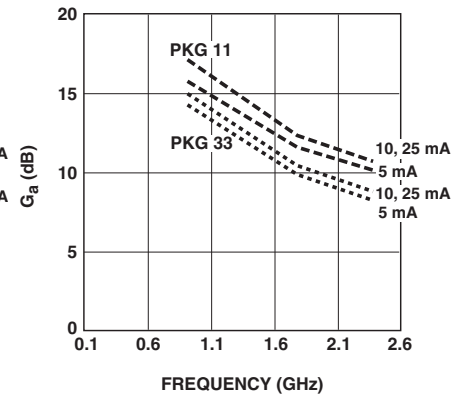

Figure 6. AT-41511 and AT-41533 Associated Gain vs. Frequency and Current at  $V_{CE} = 8$  V.

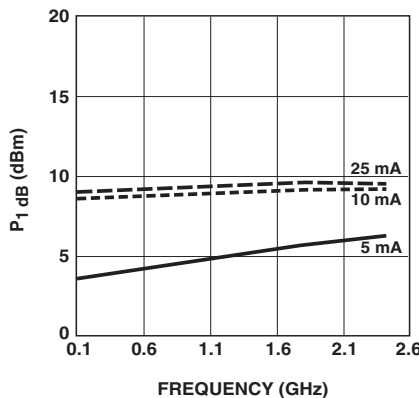

Figure 7. AT-41511 and AT-41533  $P_{1dB}$  vs. Frequency and Bias at  $V_{CE} = 2.7$  V, with Optimal Tuning.

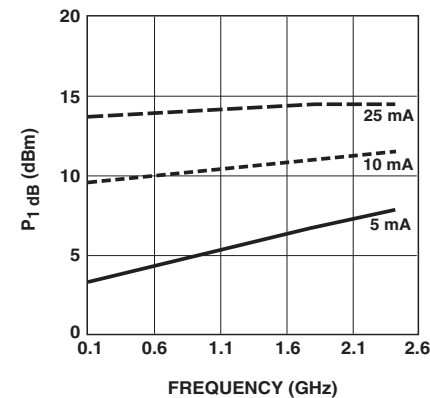

Figure 8. AT-41511 and AT-41533  $P_{1dB}$  vs. Frequency and Bias at  $V_{CE} = 5$  V, with Optimal Tuning.

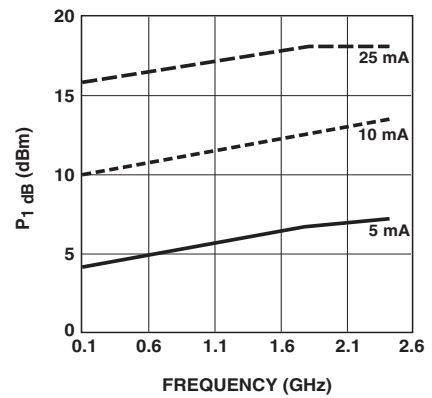

Figure 9. AT-41511 and AT-41533  $P_{1dB}$  vs. Frequency and Bias at  $V_{CE} = 8$  V, with Optimal Tuning.

**AT-41511 Typical Scattering Parameters, Common Emitter,  $Z_o = 50 \Omega, V_{CE} = 2.7 V, I_C = 5 \text{ mA}$**

Freq. GHz	$S_{11}$			$S_{21}$			$S_{12}$		$S_{22}$	
	Mag	Ang	dB	Mag	Ang	dB	Mag	Ang	Mag	Ang
0.1	0.84	-27	23.44	14.854	161	-34.89	0.018	76	0.95	-11
0.5	0.59	-102	19.01	8.924	115	-24.88	0.057	48	0.65	-34
0.9	0.49	-141	15.09	5.684	93	-22.97	0.071	43	0.51	-39
1.0	0.48	-149	14.30	5.189	89	-22.73	0.073	43	0.49	-39
1.5	0.46	-176	11.15	3.61	72	-21.21	0.087	44	0.44	-43
1.8	0.46	170	9.69	3.051	64	-20.26	0.097	45	0.43	-45
2.0	0.46	162	8.86	2.774	59	-19.74	0.103	45	0.42	-47
2.4	0.47	148	7.37	2.337	50	-18.64	0.117	46	0.42	-51
3.0	0.5	130	5.58	1.901	36	-17.14	0.139	45	0.41	-59
4.0	0.56	106	3.25	1.454	17	-14.89	0.18	42	0.4	-73
5.0	0.61	87	1.36	1.17	0	-12.96	0.225	37	0.4	-91

**AT-41511 Typical Noise Parameters,  
Common Emitter,  $Z_o = 50 \Omega, V_{CE} = 2.7 V, I_C = 5 \text{ mA}$**

Freq GHz	$F_{min}$	$\Gamma_{opt}$		$R_n$
	dB	Mag	Ang	
0.1	0.8	0.45	6	0.25
0.9	1.0	0.39	63	0.19
1.8	1.4	0.32	137	0.12
2.4	1.7	0.40	177	0.09

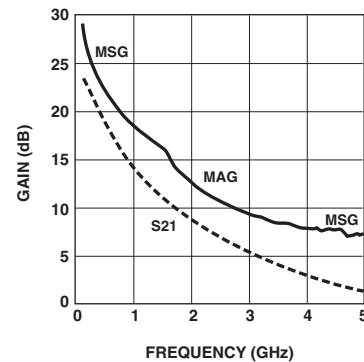

Figure 10. AT-41511 Gains vs. Frequency at  $V_{CE} = 2.7 V, I_C = 5 \text{ mA}$ .

**AT-41533 Typical Scattering Parameters, Common Emitter,  $Z_o = 50 \Omega, V_{CE} = 2.7 V, I_C = 5 \text{ mA}$**

Freq. GHz	$S_{11}$			$S_{21}$			$S_{12}$		$S_{22}$	
	Mag	Ang	dB	Mag	Ang	dB	Mag	Ang	Mag	Ang
0.1	0.78	-30	23.43	14.834	155	-33.98	0.020	75	0.94	-12
0.5	0.35	-99	16.91	7.004	103	-24.58	0.059	60	0.62	-28
0.9	0.23	-144	12.50	4.219	84	-21.21	0.087	62	0.55	-30
1.0	0.21	-154	11.65	3.826	80	-20.54	0.094	63	0.54	-31
1.5	0.20	162	8.50	2.661	64	-17.46	0.134	64	0.52	-36
1.8	0.22	144	7.09	2.261	56	-15.97	0.159	63	0.51	-40
2.0	0.23	134	6.30	2.065	51	-15.09	0.176	63	0.51	-42
2.4	0.26	118	4.97	1.773	42	-13.39	0.214	61	0.50	-48
3.0	0.30	101	3.45	1.488	30	-11.21	0.275	56	0.48	-58
4.0	0.37	80	1.66	1.211	13	-8.20	0.389	46	0.45	-80
5.0	0.44	62	0.35	1.041	-1	-5.90	0.507	33	0.42	-104

**AT-41533 Typical Noise Parameters,  
Common Emitter,  $Z_o = 50 \Omega, V_{CE} = 2.7 V, I_C = 5 \text{ mA}$**

Freq GHz	$F_{min}$	$\Gamma_{opt}$		$R_n$
	dB	Mag	Ang	
0.1	0.7	0.45	8	0.20
0.9	1.0	0.25	94	0.13
1.8	1.4	0.38	-159	0.08
2.4	1.6	0.54	-122	0.16

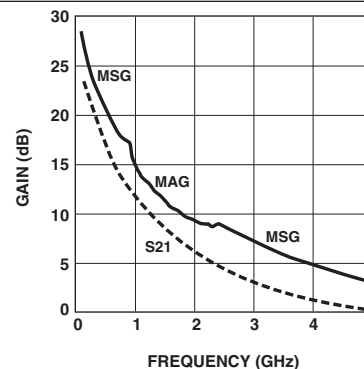

Figure 11. AT-41533 Gains vs. Frequency at  $V_{CE} = 2.7 V, I_C = 5 \text{ mA}$ .

**AT-41511 Typical Scattering Parameters, Common Emitter,  $Z_o = 50 \Omega$ ,  $V_{CE} = 2.7 V$ ,  $I_C = 25 mA$**

Freq. GHz	$S_{11}$			$S_{21}$			$S_{12}$		$S_{22}$	
	Mag	Ang	dB	Mag	Ang	dB	Mag	Ang	Mag	Ang
0.1	0.49	-91	29.26	29.048	136	-37.72	0.013	62	0.73	-22
0.5	0.53	-168	18.55	8.459	92	-30.46	0.030	61	0.45	-23
0.9	0.53	172	13.62	4.798	79	-26.56	0.047	66	0.42	-26
1.0	0.53	169	12.73	4.330	76	-25.68	0.052	67	0.42	-27
1.5	0.54	153	9.34	2.932	63	-22.50	0.075	67	0.42	-34
1.8	0.55	145	7.86	2.473	57	-21.01	0.089	66	0.42	-38
2.0	0.56	140	6.97	2.232	52	-20.09	0.099	66	0.42	-41
2.4	0.57	129	5.47	1.877	44	-18.49	0.119	64	0.42	-48
3.0	0.60	116	3.67	1.525	32	-16.54	0.149	59	0.41	-58
4.0	0.64	95	1.30	1.162	14	-13.98	0.200	51	0.40	-75
5.0	0.67	79	-0.58	0.935	-1	-11.90	0.254	43	0.39	-96

**AT-41511 Typical Noise Parameters,**

Common Emitter,  $Z_o = 50 \Omega$ ,  $V_{CE} = 2.7 V$ ,  $I_C = 25 mA$

Freq GHz	$F_{min}$ dB	$\Gamma_{opt}$ Mag	$\Gamma_{opt}$ Ang	$R_n$ -
0.1	1.6	0.13	18	0.16
0.9	1.9	0.24	-162	0.13
1.8	2.3	0.40	-137	0.23
2.4	2.7	0.50	-122	0.35

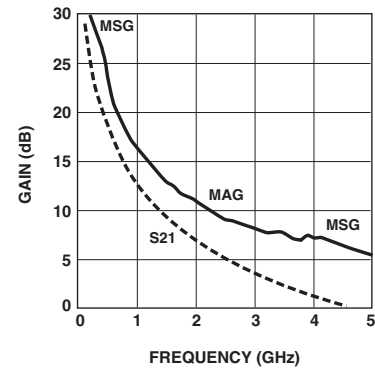

Figure 12. AT-41511 Gains vs. Frequency at  $V_{CE} = 2.7 V$ ,  $I_C = 25 mA$ .

**AT-41533 Typical Scattering Parameters, Common Emitter,  $Z_o = 50 \Omega$ ,  $V_{CE} = 2.7 V$ ,  $I_C = 25 mA$**

Freq. GHz	$S_{11}$			$S_{21}$			$S_{12}$		$S_{22}$	
	Mag	Ang	dB	Mag	Ang	dB	Mag	Ang	Mag	Ang
0.1	0.34	-75	29.37	29.404	127	-37.08	0.014	72	0.71	-21
0.5	0.19	-168	17.63	7.614	88	-25.68	0.052	76	0.47	-20
0.9	0.20	161	12.73	4.329	74	-20.82	0.091	74	0.46	-24
1.0	0.20	154	11.84	3.909	71	-19.91	0.101	74	0.45	-26
1.5	0.24	132	8.56	2.679	59	-16.42	0.151	70	0.45	-33
1.8	0.25	121	7.12	2.271	52	-14.85	0.181	67	0.44	-38
2.0	0.27	115	6.32	2.071	47	-13.94	0.201	65	0.44	-41
2.4	0.29	105	4.99	1.777	39	-12.32	0.242	61	0.43	-48
3.0	0.33	93	3.46	1.489	27	-10.31	0.305	54	0.41	-59
4.0	0.39	76	1.69	1.215	11	-7.66	0.414	42	0.37	-81
5.0	0.45	60	0.40	1.047	-3	-5.73	0.517	29	0.33	-106

**AT-41533 Typical Noise Parameters,**

Common Emitter,  $Z_o = 50 \Omega$ ,  $V_{CE} = 2.7 V$ ,  $I_C = 25 mA$

Freq GHz	$F_{min}$ dB	$\Gamma_{opt}$ Mag	$\Gamma_{opt}$ Ang	$R_n$ -
0.1	1.3	0.10	24	0.12
0.9	1.6	0.25	-158	0.11
1.8	1.9	0.48	-122	0.19
2.4	2.1	0.59	-101	0.37

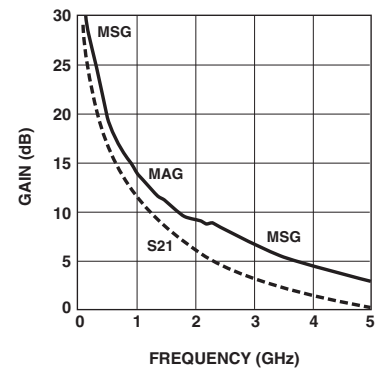

Figure 13. AT-41533 Gains vs. Frequency at  $V_{CE} = 2.7 V$ ,  $I_C = 25 mA$ .

**AT-41511 Typical Scattering Parameters, Common Emitter,  $Z_o = 50 \Omega$ ,  $V_{CE} = 5 V$ ,  $I_C = 5 mA$**

Freq. GHz	$S_{11}$			$S_{21}$			$S_{12}$		$S_{22}$	
	Mag	Ang	dB	Mag	Ang	dB	Mag	Ang	Mag	Ang
0.1	0.88	-25	23.47	14.918	162	-34.89	0.018	77	0.95	-11
0.5	0.61	-96	19.31	9.234	116	-25.04	0.056	49	0.66	-33
0.9	0.50	-135	15.49	5.948	94	-23.22	0.069	44	0.52	-38
1.0	0.48	-142	14.70	5.433	90	-22.85	0.072	43	0.50	-39
1.5	0.45	-170	11.59	3.796	74	-21.31	0.086	44	0.45	-42
1.8	0.45	176	10.13	3.210	66	-20.45	0.095	45	0.44	-44
2.0	0.45	168	9.31	2.921	61	-19.91	0.101	46	0.43	-46
2.4	0.45	154	7.85	2.469	52	-18.86	0.114	46	0.42	-51
3.0	0.48	136	6.06	2.009	39	-17.33	0.136	46	0.42	-58
4.0	0.53	111	3.77	1.544	19	-15.09	0.176	43	0.40	-72
5.0	0.58	92	1.91	1.246	2	-13.07	0.222	39	0.40	-90

**AT-41511 Typical Noise Parameters, Common Emitter,  $Z_o = 50 \Omega$ ,  $V_{CE} = 5 V$ ,  $I_C = 5 mA$**

Freq	$F_{min}$	$\Gamma_{opt}$		$R_n$
GHz	dB	Mag	Ang	-
0.1	0.8	0.46	5	0.30
0.9	1.0	0.39	60	0.22
1.8	1.4	0.34	130	0.13
2.4	1.7	0.39	173	0.09

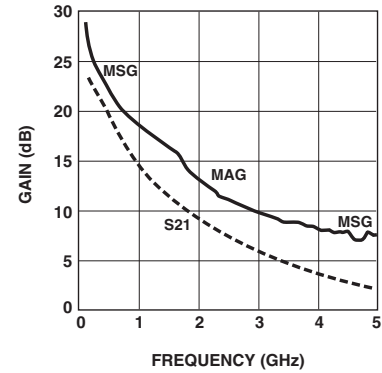

Figure 14. AT-41511 Gains vs. Frequency at  $V_{CE} = 5 V$ ,  $I_C = 5 mA$ .

**AT-41533 Typical Scattering Parameters, Common Emitter,  $Z_o = 50 \Omega$ ,  $V_{CE} = 5 V$ ,  $I_C = 5 mA$**

Freq. GHz	$S_{11}$			$S_{21}$			$S_{12}$		$S_{22}$	
	Mag	Ang	dB	Mag	Ang	dB	Mag	Ang	Mag	Ang
0.1	0.79	-28	23.48	14.932	155	-34.89	0.018	76	0.95	-11
0.5	0.36	-94	17.15	7.200	104	-25.35	0.054	61	0.65	-25
0.9	0.22	-137	12.77	4.349	84	-21.94	0.080	63	0.58	-27
1.0	0.20	-148	11.93	3.948	81	-21.21	0.087	64	0.57	-29
1.5	0.18	165	8.77	2.746	65	-18.20	0.123	65	0.56	-34
1.8	0.19	145	7.34	2.328	58	-16.65	0.147	65	0.55	-37
2.0	0.21	134	6.56	2.128	53	-15.70	0.164	65	0.55	-39
2.4	0.24	118	5.22	1.823	44	-14.02	0.199	63	0.54	-45
3.0	0.28	100	3.68	1.527	32	-11.77	0.258	59	0.53	-55
4.0	0.35	80	1.87	1.240	14	-8.61	0.371	50	0.50	-74
5.0	0.42	61	0.52	1.062	0	-6.18	0.491	37	0.47	-97

**AT-41533 Typical Noise Parameters, Common Emitter,  $Z_o = 50 \Omega$ ,  $V_{CE} = 5 V$ ,  $I_C = 5 mA$**

Freq	$F_{min}$	$\Gamma_{opt}$		$R_n$
GHz	dB	Mag	Ang	-
0.1	0.7	0.46	7	0.21
0.9	1.0	0.29	86	0.13
1.8	1.4	0.36	-163	0.07
2.4	1.6	0.53	-126	0.15

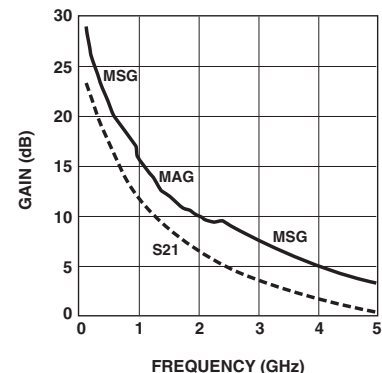

Figure 15. AT-41533 Gains vs. Frequency at  $V_{CE} = 5 V$ ,  $I_C = 5 mA$ .

**AT-41511 Typical Scattering Parameters, Common Emitter,  $Z_o = 50 \Omega$ ,  $V_{CE} = 5V$ ,  $I_C = 25 \text{ mA}$**

Freq. GHz	$S_{11}$			$S_{21}$			$S_{12}$		$S_{22}$	
	Mag	Ang	dB	Mag	Ang	dB	Mag	Ang	Mag	Ang
0.1	0.51	-74	30	32.792	140	-39	0.011	65	0.80	-19
0.5	0.46	-161	20	10.259	95	-31	0.028	62	0.51	-21
0.9	0.47	177	15	5.830	80	-27	0.043	66	0.48	-23
1.0	0.47	173	14	5.257	78	-27	0.047	67	0.48	-24
1.5	0.48	157	11	3.553	65	-23	0.068	68	0.47	-30
1.8	0.49	148	9	2.983	58	-22	0.081	68	0.48	-34
2.0	0.49	142	9	2.692	54	-21	0.090	67	0.48	-36
2.4	0.51	132	7	2.254	46	-19	0.108	65	0.48	-42
3.0	0.54	118	5	1.825	34	-17	0.135	61	0.47	-51
4.0	0.59	97	3	1.386	16	-15	0.183	54	0.46	-66
5.0	0.63	81	1	1.113	0	-13	0.234	47	0.46	-84

**AT-41511 Typical Noise Parameters,**

Common Emitter,  $Z_o = 50 \Omega$ ,  $V_{CE} = 5V$ ,  $I_C = 25 \text{ mA}$

Freq	$F_{min}$	$\Gamma_{opt}$		$R_n$
GHz	dB	Mag	Ang	-
0.1	1.6	0.08	14	0.18
0.9	1.9	0.11	165	0.16
1.8	2.3	0.28	-153	0.18
2.4	2.7	0.39	-134	0.22

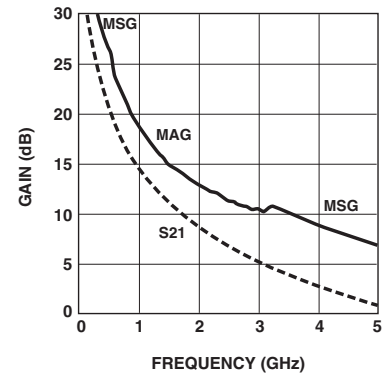

Figure 16. AT-41511 Gains vs. Frequency at  $V_{CE} = 5V$ ,  $I_C = 25 \text{ mA}$ .

**AT-41533 Typical Scattering Parameters, Common Emitter,  $Z_o = 50 \Omega$ ,  $V_{CE} = 5V$ ,  $I_C = 25 \text{ mA}$**

Freq. GHz	$S_{11}$			$S_{21}$			$S_{12}$		$S_{22}$	
	Mag	Ang	dB	Mag	Ang	dB	Mag	Ang	Mag	Ang
0.1	0.37	-62	30.00	31.606	129	-37.72	0.013	73	0.74	-19
0.5	0.13	-153	18.46	8.375	89	-26.20	0.049	76	0.51	-19
0.9	0.13	163	13.56	4.764	76	-21.31	0.086	75	0.49	-23
1.0	0.13	154	12.68	4.305	73	-20.45	0.095	74	0.49	-25
1.5	0.17	128	9.38	2.945	61	-16.95	0.142	71	0.48	-31
1.8	0.19	117	7.93	2.493	54	-15.39	0.170	68	0.48	-35
2.0	0.20	111	7.14	2.274	50	-14.47	0.189	66	0.48	-38
2.4	0.23	102	5.80	1.949	42	-12.84	0.228	62	0.47	-44
3.0	0.27	90	4.25	1.632	31	-10.84	0.287	56	0.45	-54
4.0	0.33	76	2.48	1.331	14	-8.13	0.392	45	0.42	-74
5.0	0.39	60	1.19	1.147	-1	-6.09	0.496	32	0.38	-97

**AT-41533 Typical Noise Parameters,**

Common Emitter,  $Z_o = 50 \Omega$ ,  $V_{CE} = 5V$ ,  $I_C = 25 \text{ mA}$

Freq	$F_{min}$	$\Gamma_{opt}$		$R_n$
GHz	dB	Mag	Ang	-
0.1	1.3	0.08	13	0.12
0.9	1.6	0.19	-170	0.10
1.8	1.9	0.42	-126	0.16
2.4	2.1	0.55	-105	0.32

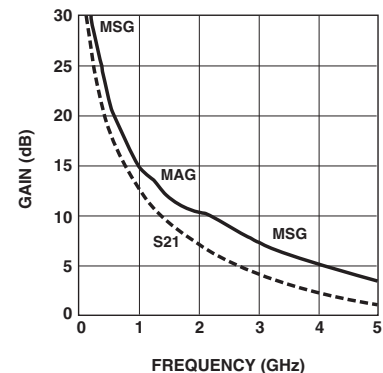

Figure 17. AT-41533 Gains vs. Frequency at  $V_{CE} = 5V$ ,  $I_C = 25 \text{ mA}$ .



**AT-41511 Typical Scattering Parameters, Common Emitter,  $Z_o = 50 \Omega$ ,  $V_{CE} = 8V$ ,  $I_C = 10 \text{ mA}$**

Freq. GHz	$S_{11}$			$S_{21}$			$S_{12}$		$S_{22}$	
	Mag	Ang	dB	Mag	Ang	dB	Mag	Ang	Mag	Ang
0.1	0.75	-36	27.71	24.305	155	-37.72	0.013	73	0.92	-13
0.5	0.47	-119	21.24	11.535	106	-28.87	0.036	53	0.60	-27
0.9	0.41	-155	16.80	6.921	88	-26.20	0.049	55	0.51	-28
1.0	0.40	-161	15.96	6.281	84	-25.68	0.052	56	0.50	-29
1.5	0.39	174	12.66	4.294	70	-23.10	0.070	58	0.48	-32
1.8	0.40	162	11.16	3.615	63	-21.83	0.081	59	0.48	-35
2.0	0.40	155	10.29	3.269	59	-21.11	0.088	58	0.48	-37
2.4	0.42	143	8.77	2.745	50	-19.66	0.104	58	0.48	-41
3.0	0.44	126	6.95	2.226	38	-17.86	0.128	55	0.47	-48
4.0	0.51	104	4.60	1.698	19	-15.44	0.169	50	0.46	-61
5.0	0.56	87	2.73	1.370	3	-13.39	0.214	45	0.46	-76

**AT-41511 Typical Noise Parameters, Common Emitter,  $Z_o = 50 \Omega$ ,  $V_{CE} = 8V$ ,  $I_C = 10 \text{ mA}$**

Freq GHz	$F_{min}$ dB	$\Gamma_{opt}$		$R_n$ -
		Mag	Ang	
0.1	1.1	0.40	7	0.27
0.9	1.3	0.33	62	0.20
1.8	1.6	0.27	135	0.13
2.4	1.8	0.35	178	0.10

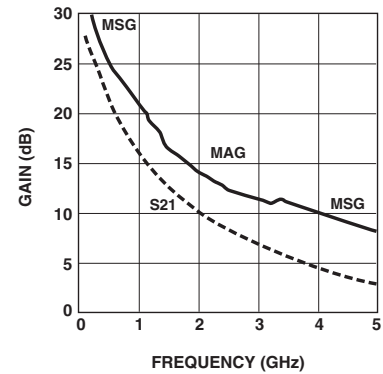

Figure 18. AT-41511 Gains vs. Frequency at  $V_{CE} = 8V$ ,  $I_C = 10 \text{ mA}$ .

**AT-41533 Typical Scattering Parameters, Common Emitter,  $Z_o = 50 \Omega$ ,  $V_{CE} = 8V$ ,  $I_C = 10 \text{ mA}$**

Freq. GHz	$S_{11}$			$S_{21}$			$S_{12}$		$S_{22}$	
	Mag	Ang	dB	Mag	Ang	dB	Mag	Ang	Mag	Ang
0.1	0.65	-37	27.45	23.576	145	-35.92	0.016	73	0.88	-15
0.5	0.20	-100	18.60	8.509	97	-26.20	0.049	69	0.57	-23
0.9	0.11	-146	13.89	4.947	81	-21.83	0.081	71	0.54	-25
1.0	0.09	-161	13.03	4.482	78	-20.92	0.090	70	0.53	-26
1.5	0.11	144	9.77	3.081	64	-17.59	0.132	69	0.52	-32
1.8	0.13	125	8.34	2.611	58	-16.03	0.158	67	0.51	-35
2.0	0.14	116	7.53	2.379	53	-15.09	0.176	65	0.51	-38
2.4	0.17	104	6.20	2.041	45	-13.47	0.212	62	0.50	-43
3.0	0.22	91	4.66	1.710	33	-11.40	0.269	57	0.49	-52
4.0	0.28	77	2.90	1.396	16	-8.61	0.371	47	0.46	-71
5.0	0.35	62	1.61	1.204	1	-6.45	0.476	35	0.43	-92

**AT-41533 Typical Noise Parameters, Common Emitter,  $Z_o = 50 \Omega$ ,  $V_{CE} = 8V$ ,  $I_C = 10 \text{ mA}$**

Freq GHz	$F_{min}$ dB	$\Gamma_{opt}$		$R_n$ -
		Mag	Ang	
0.1	0.8	0.40	13	0.18
0.9	1.1	0.20	93	0.12
1.8	1.5	0.32	-154	0.09
2.4	1.7	0.49	-121	0.17

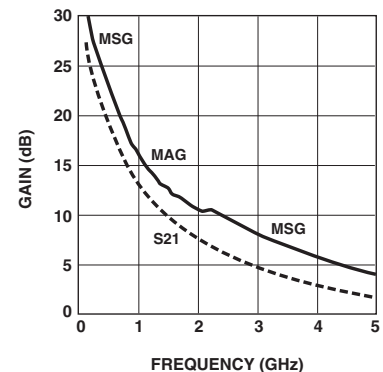

Figure 19. AT-41533 Gains vs. Frequency at  $V_{CE} = 8V$ ,  $I_C = 10 \text{ mA}$ .

**AT-41511 Typical Scattering Parameters, Common Emitter,  $Z_o = 50 \Omega$ ,  $V_{CE} = 8V$ ,  $I_C = 25 \text{ mA}$**

Freq. GHz	$S_{11}$			$S_{21}$			$S_{12}$		$S_{22}$	
	Mag	Ang	dB	Mag	Ang	dB	Mag	Ang	Mag	Ang
0.1	0.55	-65	30.44	33.264	142	-39.17	0.011	66	0.82	-17
0.5	0.44	-155	20.69	10.832	96	-31.37	0.027	61	0.54	-21
0.9	0.44	-179	15.83	6.190	81	-27.54	0.042	66	0.50	-22
1.0	0.44	176	14.95	5.588	78	-26.74	0.046	67	0.50	-23
1.5	0.45	159	11.55	3.779	66	-23.61	0.066	67	0.49	-29
1.8	0.46	150	10.03	3.173	59	-22.16	0.078	67	0.50	-32
2.0	0.46	144	9.14	2.865	55	-21.31	0.086	66	0.50	-35
2.4	0.48	133	7.61	2.401	46	-19.66	0.104	65	0.50	-40
3.0	0.51	119	5.78	1.945	35	-17.72	0.130	61	0.49	-48
4.0	0.57	99	3.39	1.477	17	-15.09	0.176	55	0.49	-63
5.0	0.61	83	1.49	1.187	1	-12.92	0.226	48	0.48	-80

**AT-41511 Typical Noise Parameters, Common Emitter,  $Z_o = 50 \Omega$ ,  $V_{CE} = 8V$ ,  $I_C = 25 \text{ mA}$**

Freq	$F_{min}$	$\Gamma_{opt}$		$R_n$
GHz	dB	Mag	Ang	-
0.1	1.6	0.08	10	0.20
0.9	1.9	0.10	100	0.19
1.8	2.3	0.22	-170	0.18
2.4	2.7	0.32	-147	0.18

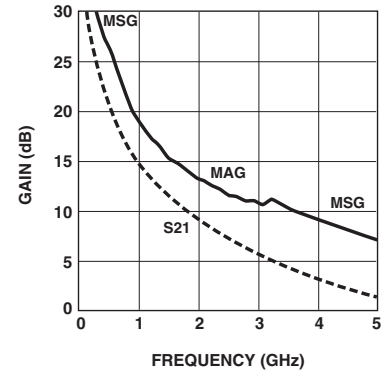

Figure 20. AT-41511 Gains vs. Frequency at  $V_{CE} = 8V$ ,  $I_C = 25 \text{ mA}$ .

**AT-41533 Typical Scattering Parameters, Common Emitter,  $Z_o = 50 \Omega$ ,  $V_{CE} = 8V$ ,  $I_C = 25 \text{ mA}$**

Freq. GHz	$S_{11}$			$S_{21}$			$S_{12}$		$S_{22}$	
	Mag	Ang	dB	Mag	Ang	dB	Mag	Ang	Mag	Ang
0.1	0.41	-57	30.11	32.026	130	-37.72	0.013	73	0.76	-18
0.5	0.11	-138	18.75	8.664	90	-26.38	0.048	76	0.52	-19
0.9	0.10	168	13.87	4.938	77	-21.51	0.084	75	0.50	-22
1.0	0.10	156	12.99	4.460	74	-20.63	0.093	74	0.50	-24
1.5	0.14	126	9.70	3.054	62	-17.14	0.139	71	0.49	-31
1.8	0.16	115	8.25	2.585	55	-15.60	0.166	68	0.49	-34
2.0	0.17	108	7.45	2.359	51	-14.66	0.185	66	0.49	-37
2.4	0.20	99	6.11	2.020	43	-13.03	0.223	62	0.48	-43
3.0	0.24	89	4.56	1.691	32	-11.03	0.281	56	0.46	-53
4.0	0.30	75	2.80	1.380	15	-8.31	0.384	45	0.43	-72
5.0	0.37	61	1.51	1.190	0	-6.25	0.487	33	0.39	-94

**AT-41533 Typical Noise Parameters, Common Emitter,  $Z_o = 50 \Omega$ ,  $V_{CE} = 8V$ ,  $I_C = 25 \text{ mA}$**

Freq	$F_{min}$	$\Gamma_{opt}$		$R_n$
GHz	dB	Mag	Ang	-
0.1	1.3	0.07	18	0.16
0.9	1.6	0.12	164	0.12
1.8	1.9	0.36	-134	0.15
2.4	2.1	0.51	-109	0.28

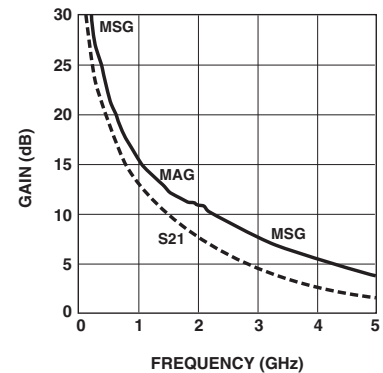

Figure 21. AT-41533 Gains vs. Frequency at  $V_{CE} = 8V$ ,  $I_C = 25 \text{ mA}$ .

## Ordering Information

Part Numbers		No. of Devices	Comments
AT-41511-BLKG	AT-41533-BLKG	100	Bulk
AT-41511-TR1G	AT-41533-TR1G	3000	7" Reel
AT-41511-TR2G	AT-41533-TR2G	10000	13" Reel

## Package Dimensions

### SOT-23 Plastic Package

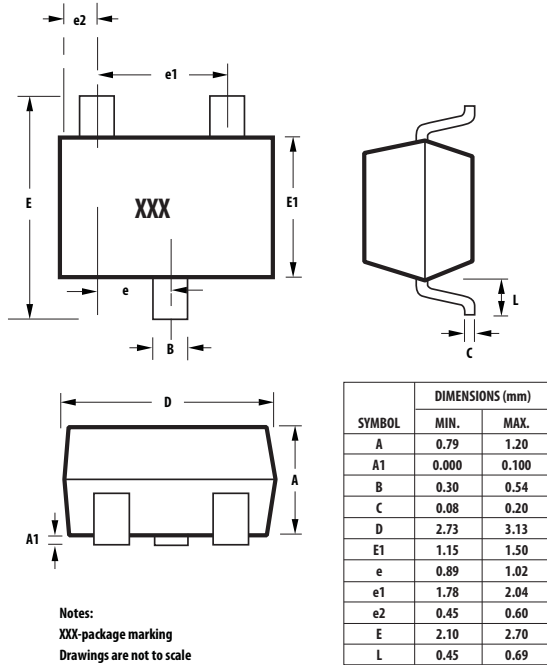

### SOT-143 Plastic Package

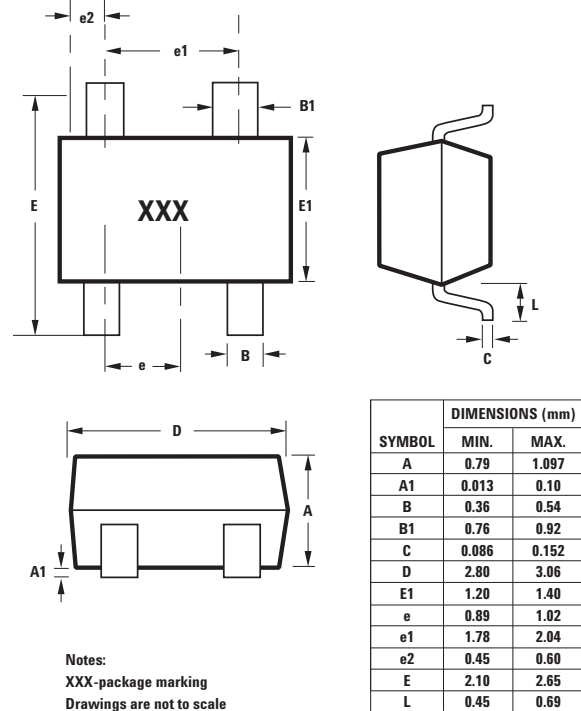

For product information and a complete list of distributors, please go to our web site: [www.avagotech.com](http://www.avagotech.com)

Avago, Avago Technologies, and the A logo are trademarks of Avago Technologies in the United States and other countries. Data subject to change. Copyright © 2005-2009 Avago Technologies. All rights reserved. Obsoletes 5989-2649EN AV02-0798EN - December 23, 2009

**Avago**  
TECHNOLOGIES