



Chipsmall Limited consists of a professional team with an average of over 10 year of expertise in the distribution of electronic components. Based in Hongkong, we have already established firm and mutual-benefit business relationships with customers from,Europe,America and south Asia,supplying obsolete and hard-to-find components to meet their specific needs.

With the principle of “Quality Parts,Customers Priority,Honest Operation,and Considerate Service”,our business mainly focus on the distribution of electronic components. Line cards we deal with include Microchip,ALPS,ROHM,Xilinx,Pulse,ON,Everlight and Freescale. Main products comprise IC,Modules,Potentiometer,IC Socket,Relay,Connector.Our parts cover such applications as commercial,industrial, and automotives areas.

We are looking forward to setting up business relationship with you and hope to provide you with the best service and solution. Let us make a better world for our industry!



Contact us

Tel: +86-755-8981 8866 Fax: +86-755-8427 6832

Email & Skype: info@chipsmall.com Web: www.chipsmall.com

Address: A1208, Overseas Decoration Building, #122 Zhenhua RD., Futian, Shenzhen, China



REVISIONS					
REV	ECO	DESCRIPTION	DATE	BY	APPR
A	-	RELEASE	19SEP13	DRP	-

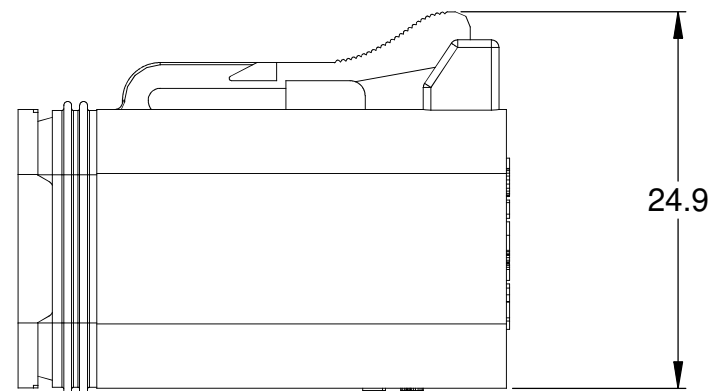
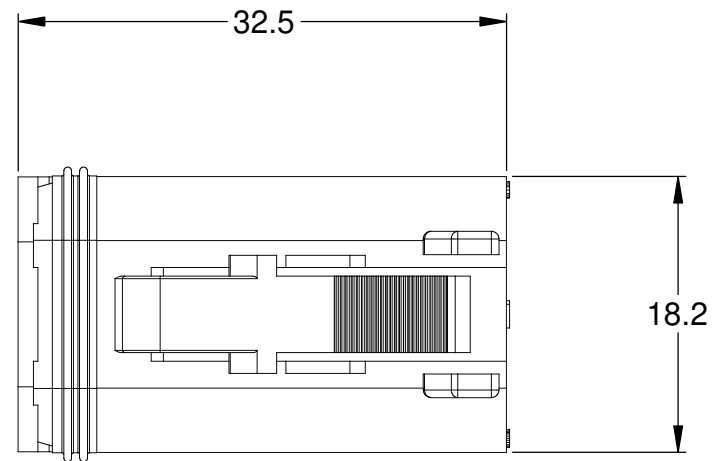

REFERENCE DIMENSIONS - ASSEMBLED

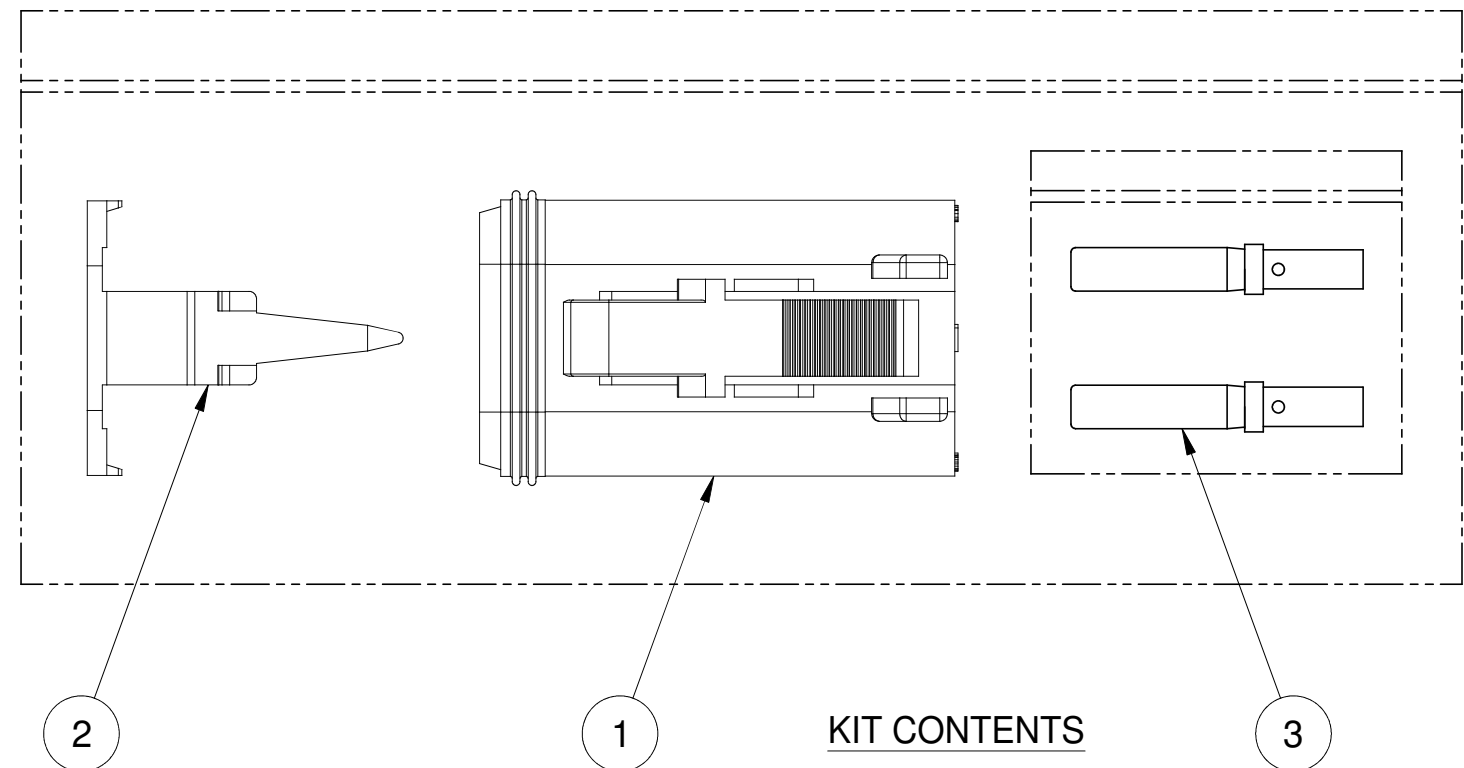
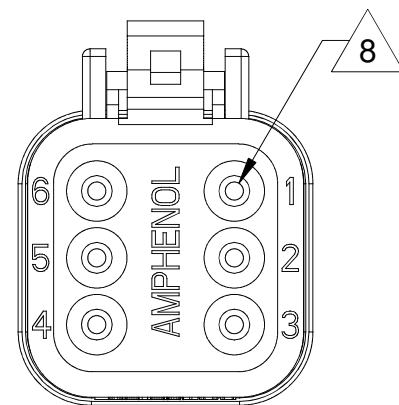

KIT CONTENTS

NOTES: UNLESS OTHERWISE SPECIFIED

1. MATERIAL:

HOUSING: THERMOPLASTIC; COLOR: GREY
 WEDGELOCK: THERMOPLASTIC; COLOR: GREEN
 SEALS: SILICONE RUBBER
 CONTACTS: COPPER ALLOY; NICKEL PLATED

2. SPECIFICATIONS:

- 2.1 CURRENT RATING: 13 AMPS
- 2.2 OPERATING TEMPERATURE: -55°C TO +125°C
- 2.3 DIELECTRIC WITHSTANDING VOLTAGE: LESS THAN 2 MILLIAMPS CURRENT LEAKAGE @ 1500 VOLTS AC.
- 2.4 INSULATION RESISTANCE: 1000 MEGOHMS MIN @ 25°C.
- 2.5 CONTACT MILLIVOLT DROP: 60 MILLIVOLT DROP @ 13 AMP TEST CURRENT.
- 2.6 MOISTURE RESISTANCE: IP67 (MATED CONDITION)
- 2.7 CONNECTOR MATING CYCLE DURABILITY: 100 CYCLES

- 3. MATING PART: AT04-6P* RECEPTACLE (* = MODIFICATIONS AND COLORS)
- 4. AVAILABLE HAND CRIMPER: CA-5D12
- 5. ALL COMPONENTS ARE RoHS COMPLIANT.
- 6. ALL DIMENSIONS ARE FOR REFERENCE USE ONLY.

7 WIRE RANGE OF CONTACTS INCLUDED IN KIT: 16 - 20 AWG

8 CONTACT SIZE AND REAR SEAL WIRE RANGE:

CONTACT SIZE	MIN. INSUL. O.D.	MAX. INSUL. O.D.	TYPICAL WIRE RANGE
16	2.24 mm (.088 in)	3.68 mm (.145 in)	14 - 20 AWG

QUANTITY	PART NUMBER	DESCRIPTION	ITEM
6	AT62-201-16141	CONTACT, SOCKET, SOLID, SIZE 16, 16 - 20 AWG	3
1	AW6S	S-WEDGELOCK, 6 POSITION, AT SERIES	2
1	AT06-6S	PLUG, 6 SOCKET, AT SERIES	1

MATERIALS LIST

UNLESS OTHERWISE SPECIFIED 1) All dimensions are in metric(mm). 2) Tolerances are as follows: 1 PL DEC ±0.30 2 PL DEC ±0.15 3 PL DEC ±0.08 Fractions ±1/64 Angles ±1° 3) Note reference = X		SIGNATURES DRAWN: D.PARKS CHECKED: ENGINEER: APPROVAL:	DATE 19SEP13	<h1>Amphenol</h1> <p>Sine Systems - www.amphenol-sine.com 44724 Morley Drive Clinton Township, MI 48036</p>
MATERIAL SPECIFICATIONS:	CUSTOMER:	THIS DRAWING IS SUPPLIED FOR INFORMATION ONLY. DESIGN FEATURES, SPECIFICATIONS AND PERFORMANCE DATA SHOWN HEREON ARE THE PROPERTY OF THE AMPHENOL CORPORATION. NO RIGHTS OF REPRODUCTION ARE IMPLIED. ALL DIMENSIONS ARE SUBJECT TO NORMAL MANUFACTURING VARIATIONS.		
PROCESS SPECIFICATIONS:	KIT, AT SERIES, 6 POSITION PLUG, CONTACTS, AND WEDGELOCK		SIZE: B C- SCALE: NONE	DWG NO: AT06-6S-KIT01 REVISION: A
NEXT ASSY:	SHEET 1 OF 1			

TITLE: KIT, AT SERIES, 6 POS PLUG, CONTACTS, AND WEDGELOCK
 DWG NO: AT06-6S-KIT01
 REV: A
 SH: 1
 OF: 1