



Chipsmall Limited consists of a professional team with an average of over 10 year of expertise in the distribution of electronic components. Based in Hongkong, we have already established firm and mutual-benefit business relationships with customers from,Europe,America and south Asia,supplying obsolete and hard-to-find components to meet their specific needs.

With the principle of “Quality Parts,Customers Priority,Honest Operation,and Considerate Service”,our business mainly focus on the distribution of electronic components. Line cards we deal with include Microchip,ALPS,ROHM,Xilinx,Pulse,ON,Everlight and Freescale. Main products comprise IC,Modules,Potentiometer,IC Socket,Relay,Connector.Our parts cover such applications as commercial,industrial, and automotives areas.

We are looking forward to setting up business relationship with you and hope to provide you with the best service and solution. Let us make a better world for our industry!



Contact us

Tel: +86-755-8981 8866 Fax: +86-755-8427 6832

Email & Skype: info@chipsmall.com Web: www.chipsmall.com

Address: A1208, Overseas Decoration Building, #122 Zhenhua RD., Futian, Shenzhen, China



Distinctive Characteristics

DSA

- Environmentally friendly, contains no mercury.
- High contact reliability due to sealed body.
- The switch is triggered when tilted beyond $\pm 10^\circ$ of the horizontal.
- PCB adaptor available as an accessory.



DSB

- Photo interrupter, rather than contacts, ensures high reliability. 1 million operations minimum.
- Sealed construction for protection from environmental elements, including hydrogen sulfide, sulfur dioxide, and nitrogen hydroxide. Terminals are made of ammonia-resistant materials.
- Totally sealed body allows process compatibility for time- and money-saving automatic soldering and cleaning.
- Space-saving compact dimensions allow high density mounting.
- Internal steel ball movement allows functionality of 360° circumference rotation.
- The DSB series switch is well-suited to meet product safety concerns due to normally closed (on) status.
- Crimped terminals ensure secure mounting and prevent dislodging during wave soldering.
- The switch is triggered when tilted beyond $\pm 30^\circ$ of the horizontal.

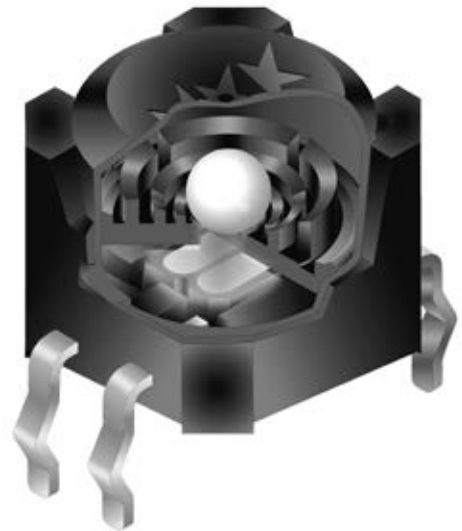

Actual Sizes

DSA

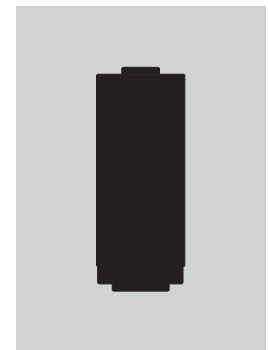

DSB

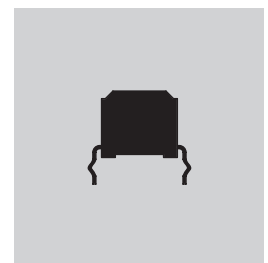

Toggles

Rockers

Pushbuttons

Illuminated PB

Programmable

Keylocks

Rotaries

Slides

Tactiles

K Tilt

Touch

Indicators

Accessories

Supplement

DSA SWITCH PART NUMBER & DESCRIPTION



DSA SWITCH SPECIFICATIONS

Mechanical & Electrical Specifications

Poles and Circuits:	Single Pole Single Throw ON - OFF
Operating Range:	ON Angle = 10° ~ 170°; OFF Angle = 190° ~ 350°
Resistive Load:	0.1A @ 12V DC
Contact Resistance:	100 milliohms maximum
Insulation Resistance:	50 megohms minimum @ 250V DC
Dielectric Strength:	250V AC for 1 minute minimum between terminals
Mechanical Life:	100,000 operations minimum
Electrical Life:	100,000 operations minimum

Materials & Finishes

Housing:	PBT
Rubber Rings:	Nitrile Butadiene Rubber
Contact Balls:	Brass with Silver Plating
Terminals:	Brass with Silver Plating

Environmental Specifications

Operating Temperature Range:	-10°C ~ +70°C (+14°F ~ +158°F)
Storage Temperature Range:	-25°C ~ +85°C (-13°F ~ +185°F)
Contact Bounce (for reference):	500ms maximum
Humidity:	90% humidity for 96 hours @ 40°C (104°F)
Vibration (for reference):	Frequency range 10Hz ~ 500Hz for 2 hours; 2 directions; Acceleration: 0.2G
Notes:	1. Do not install switch near vibration source. 2. Terminals should not be exposed to liquid.

Processing for AT094 PCB Adaptor

Soldering (with PCB Mount Holder):	Wave Soldering: See Profile A in Supplement section. Manual Soldering: See Profile B in Supplement section.
Automated Cleaning:	Hand clean locally using alcohol based solution.

DSA SWITCH SPECIFICATIONS (CONTINUED)

Operating Range

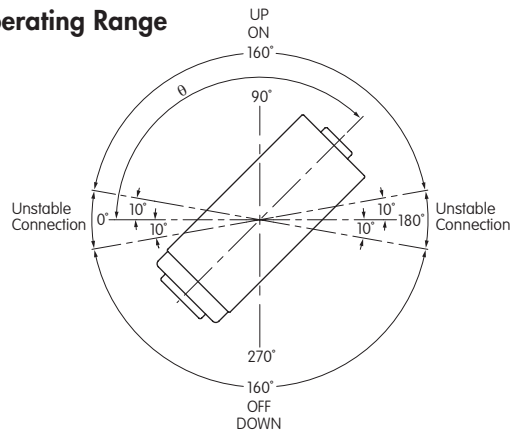

Cross Section

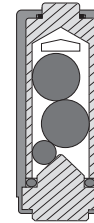

Allow 500ms settling time between states.

TYPICAL SWITCH DIMENSIONS

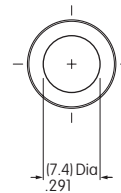
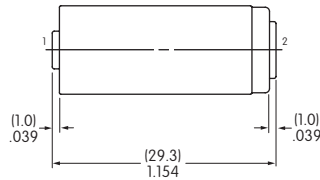
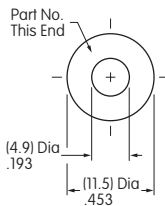

DSA01

Terminal numbers are not on the switch.

OPTIONAL ADAPTOR



AT094
PCB Adaptor for DSA01

Materials:
Holder: Polypropylene
Spring: Spring Steel with Nickel Plating
PC Pins: Brass with Nickel Plating



Assembled DSA Switch & Adaptor

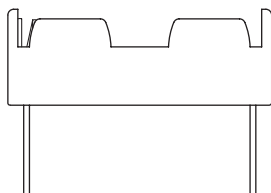
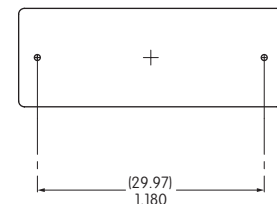
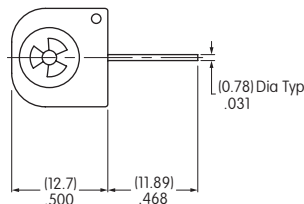
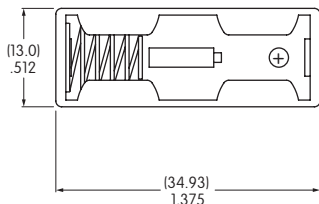

PCB Footprint

DSB SWITCH PART NUMBERS & DESCRIPTION

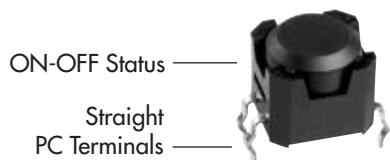

DSBA1P

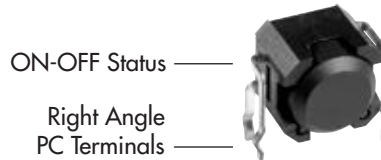

DSBA1H

DSB SWITCH SPECIFICATIONS

Absolute Maximum Ratings Temperature at 25°C

		Symbol	Rating	Unit
Input	Forward Current	I_F	50	mA
	Reverse Voltage	V_R	5	V
	Power Dissipation	P_D	75	mW
Output	Collector-Emitter Voltage	V_{CEO}	30	V
	Emitter-Collector Voltage	V_{ECO}	3	V
	Collector Current	I_C	20	mA
	Collector Power Dissipation	P_C	50	mW
	Total Power Dissipation	P_{tot}	100	mW

Mechanical Specifications

Mechanical Life:	1,000,000 operations minimum
Electrical Life:	1,000,000 operations minimum using applicable circuit

Materials & Finishes

Housing:	Glass fiber reinforced polyamide (UL94V-0 flammability rating)
Base:	Glass fiber reinforced polyamide (UL94V-0 flammability rating)
Terminals:	Phosphor bronze with tin plating

Environmental Specifications

Operating Temperature Range:	-25°C ~ +80°C (-13°F ~ +176°F)
Storage Temperature Range:	-30°C ~ +85°C (-22°F ~ +185°F)
Humidity:	85% humidity for 500 hours @ +85°C (+185°F)
Vibration:	10Hz with peak-to-peak amplitude of 10mm traversing the frequency range & returning in 1 minute; 3 right angled directions for 500,000 cycles
Shock:	100G (981m/s ²) acceleration (tested in 6 right angled directions, with 5 shocks in each direction)
Notes:	<ol style="list-style-type: none"> 1. Prevent exposure to magnetic fields. 2. Do not install switch near vibration source.

DSB SWITCH SPECIFICATIONS (CONTINUED)

Operating Characteristics

Circuit Characteristics (ON-OFF)	Operating Angle	Return Angle
	$\pm 30^\circ$ to $\pm 60^\circ$	Minimum 10°
	Output $V_{OL} \rightarrow V_{OH}$	Output $V_{OH} \rightarrow V_{OL}$

Output Characteristics V_{OL} with Photo transistor ON: 1.0V maximum (horizontal)

Output Characteristics V_{OH} with Photo transistor OFF: 4.0V minimum (inclined at an angle of -60° minimum)

Output Characteristics

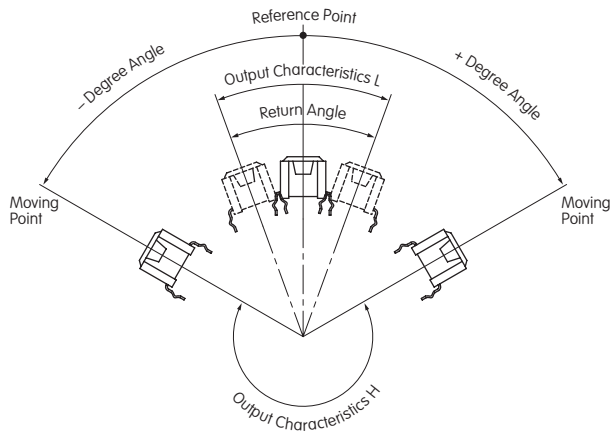

Straight PC

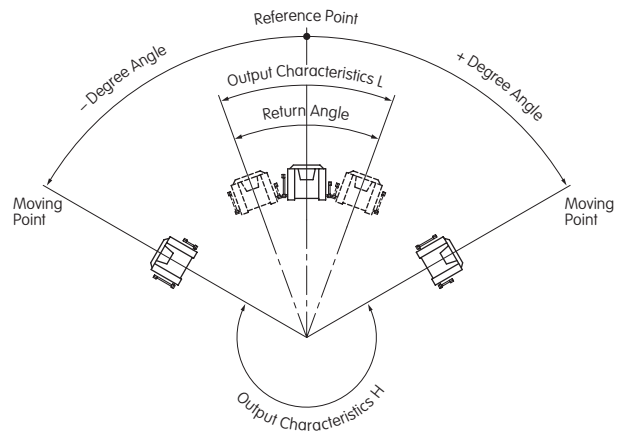

Right Angle PC

Circuit Design Considerations

$V_{CC} = 5V$
 $R_2 = 100k\Omega$
 $I_F = 19mA$ ($V_{CC} = 5V, R_1 = 200\Omega$)
 V_F of the LED Maximum = 1.3V

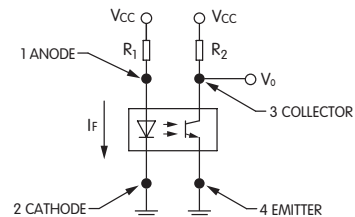

PCB Processing

Soldering : Wave Soldering: See Profile A in Supplement section.
 Manual Soldering: See Profile A in Supplement section.

Automated Cleaning: Use alcohol based solution at $50^\circ C$ maximum. Do not submerge over 2.0" (5.0cm) for 1 minute maximum. Do not use organic solvents.

MOUNTING OPTIONS

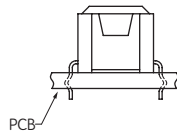

PCB mounting option for Straight PC

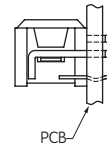

PCB mounting option for Right Angle PC

Install switch at an angle less than $\pm 3^\circ$ from the mounting surface.

TYPICAL SWITCH DIMENSIONS

Straight PC

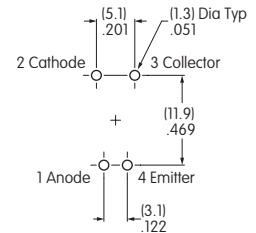
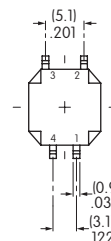
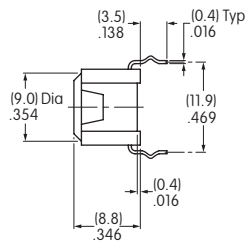
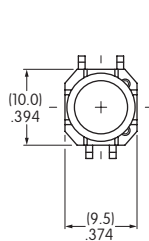

DSBA1P

Terminal numbers are on bottom of switch.

Right Angle PC

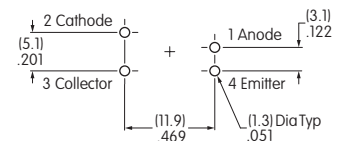
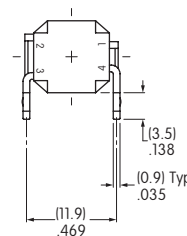
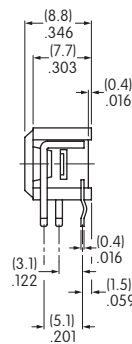
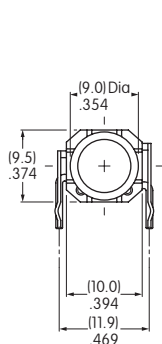

DSBA1H

Terminal numbers are on bottom of switch.