



Chipsmall Limited consists of a professional team with an average of over 10 year of expertise in the distribution of electronic components. Based in Hongkong, we have already established firm and mutual-benefit business relationships with customers from,Europe,America and south Asia,supplying obsolete and hard-to-find components to meet their specific needs.

With the principle of “Quality Parts,Customers Priority,Honest Operation,and Considerate Service”,our business mainly focus on the distribution of electronic components. Line cards we deal with include Microchip,ALPS,ROHM,Xilinx,Pulse,ON,Everlight and Freescale. Main products comprise IC,Modules,Potentiometer,IC Socket,Relay,Connector.Our parts cover such applications as commercial,industrial, and automotives areas.

We are looking forward to setting up business relationship with you and hope to provide you with the best service and solution. Let us make a better world for our industry!



## Contact us

Tel: +86-755-8981 8866 Fax: +86-755-8427 6832

Email & Skype: info@chipsmall.com Web: www.chipsmall.com

Address: A1208, Overseas Decoration Building, #122 Zhenhua RD., Futian, Shenzhen, China



## Features

- EE Programmable 262,144 x 1-, 524,288 x 1-, 1,048,576 x 1-, 2,097,152 x 1-, and 4,194,304 x 1-bit Serial Memories Designed to Store Configuration Programs for Field Programmable Gate Arrays (FPGAs)
- Available as a 3.3V ( $\pm 10\%$ ) Commercial and Industrial Version
- Simple Interface to SRAM FPGAs
- Pin Compatible with Xilinx<sup>®</sup> XC17SXXXXA and XC17SXXXXL PROMs
- Compatible with Xilinx Spartan<sup>®</sup>-II, Spartan-IIe and Spartan XL FPGAs in Master Serial Mode
- Very Low-power CMOS EEPROM Process
- Available in 8-lead PDIP, 8-lead SOIC, 20-lead SOIC and 44-lead TQFP Packages for a Specific Density
- Low-power Standby Mode
- High-reliability
  - Endurance: Minimum 10 Write Cycles
  - Data Retention: 20 Years at 85°C

## Description

The AT17N series FPGA Configuration EEPROM (Configurators) provide an easy-to-use, cost-effective configuration memory for Field Programmable Gate Arrays. The AT17N series device is packaged in the 8-lead PDIP, 8-lead SOIC, 20-lead SOIC and 44-lead TQFP, see Table 1. The AT17N series Configurators uses a simple serial-access procedure to configure one or more FPGA devices.

The AT17N series configurators can be programmed with industry-standard programmers, Atmel's ATDH2200E Programming Kit or Atmel's ATDH2225 ISP Cable and factory programming.

**Table 1.** AT17N Series Packages

Package	AT17N256	AT17N512/ AT17N010	AT17N002	AT17N040
8-lead PDIP	Yes	Yes	–	–
8-lead SOIC	Yes	–	–	–
20-lead SOIC	Yes	Yes	Yes	–
44-lead TQFP	–	–	Yes	Yes



## FPGA Configuration Memory

**AT17N256**  
**AT17N512**  
**AT17N010**  
**AT17N002**  
**AT17N040**

## 3.3V System Support

## Not Recommended For New Design

AT17N256 replaced by AT17LV256  
AT17N512 replaced by AT17LV512  
AT17N010 replaced by AT17LV010  
AT17N002 replaced by AT17LV002  
AT17N040 replaced by AT17LV040



## Pin Configuration

### 8-lead SOIC

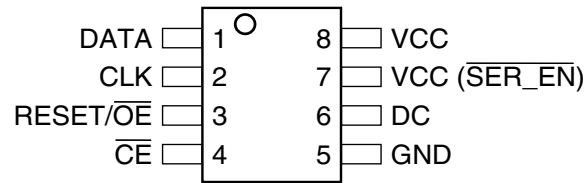

### 8-lead PDIP

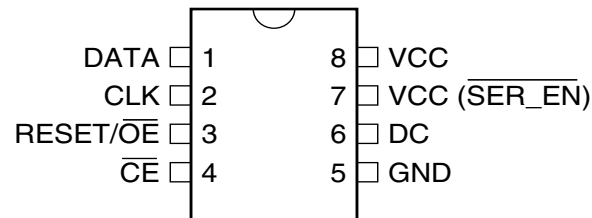

### 20-lead SOIC

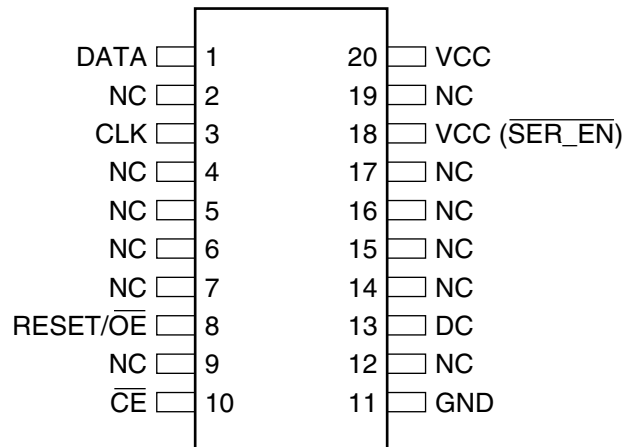

44 TQFP

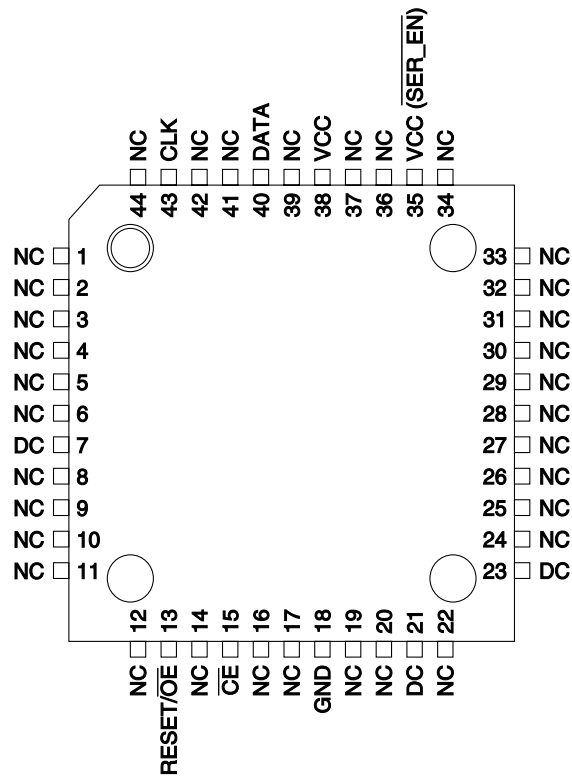

## Block Diagram

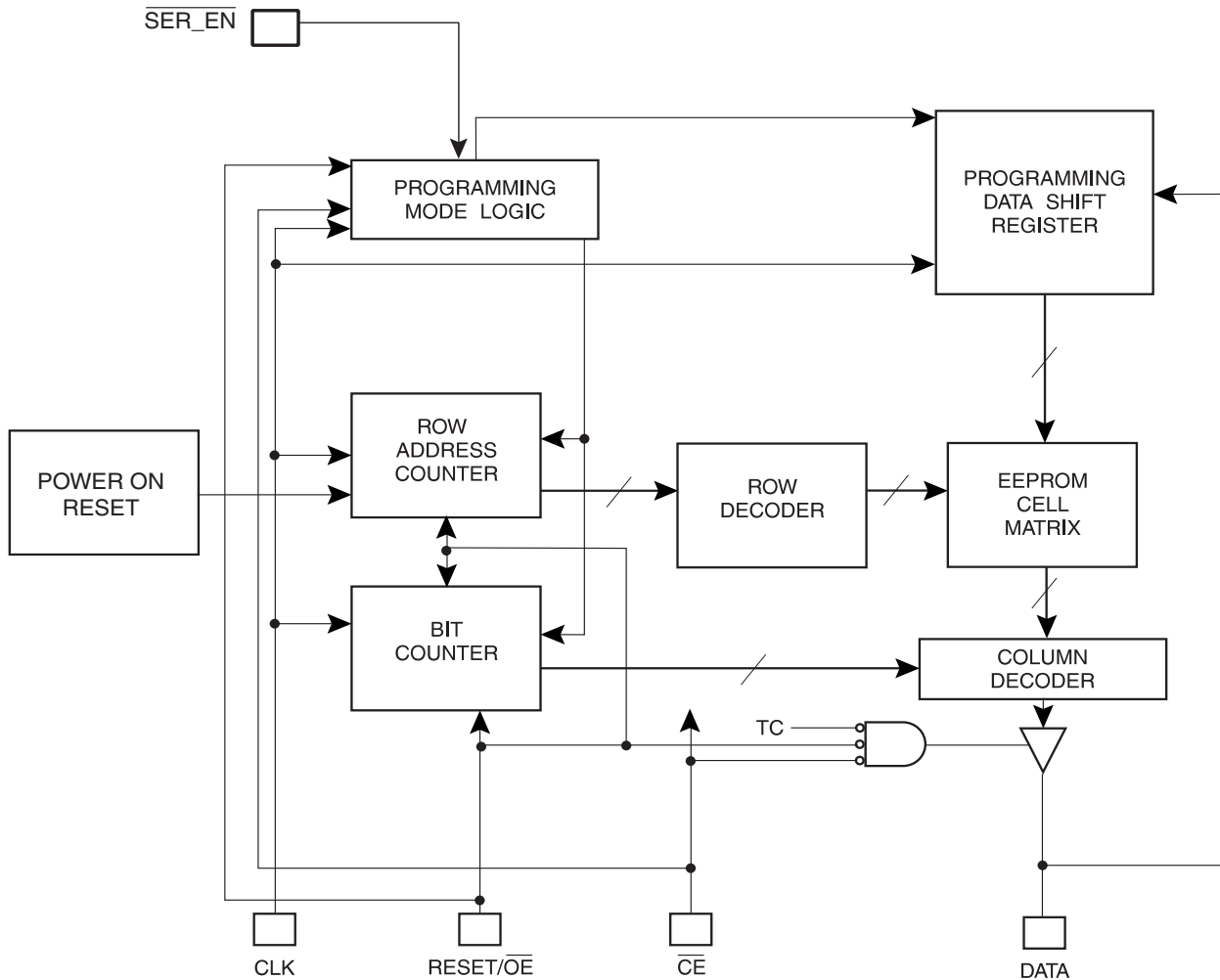

## Device Description

The control signals for the configuration EEPROM ( $\overline{CE}$ ,  $\overline{RESET/OE}$  and  $CCLK$ ) interface directly with the FPGA device control signals. All FPGA devices can control the entire configuration process and retrieve data from the configuration EEPROM without requiring an external intelligent controller.

The configuration EEPROM  $\overline{RESET/OE}$  and  $\overline{CE}$  pins control the tri-state buffer on the DATA output pin and enable the address counter. When  $\overline{RESET/OE}$  is driven High, the configuration EEPROM resets its address counter and tri-states its DATA pin. The  $\overline{CE}$  pin also controls the output of the AT17N series configurator. If  $\overline{CE}$  is held High after the  $\overline{RESET/OE}$  reset pulse, the counter is disabled and the DATA output pin is tri-stated. When  $\overline{OE}$  is subsequently driven Low, the counter and the DATA output pin are enabled. When  $\overline{RESET/OE}$  is driven High again, the address counter is reset and the DATA output pin is tri-stated, regardless of the state of  $\overline{CE}$ . Upon power-up, the address counter is automatically reset.

## Pin Description

Name	I/O	AT17N256		AT17N512/ AT17N010		AT17N002		AT17N040
		8 DIP/ SOIC	20 SOIC	8 DIP	20 SOIC	20 SOIC	44 TQFP	44 TQFP
DATA	I/O	1	1	1	1	1	40	40
CLK	I	2	3	2	3	3	43	43
RESET/ $\overline{OE}$	I	3	8	3	8	8	13	13
$\overline{CE}$	I	4	10	4	10	10	15	15
GND		5	11	5	11	11	18	18
DC	O	6	13	6	13	13	21	21
DC	O	–	–	–	–	–	23	23
VCC( $\overline{SER\_EN}$ )	I	7	18	7	18	18	35	35
V <sub>CC</sub>		8	20	8	20	20	38	38

### DATA

Three-state DATA output for configuration. Open-collector bi-directional pin for programming.

### CLK

Clock input. Used to increment the internal address and bit counter for reading and programming.

### RESET/ $\overline{OE}$

Output Enable (active High) and RESET (active Low) when  $\overline{SER\_EN}$  is High. A Low level on RESET/OE resets both the address and bit counters. A High level (with  $\overline{CE}$  Low) enables the data output driver. The logic polarity of this input is programmable as either RESET/ $\overline{OE}$  or  $\overline{RESET/OE}$ . For most applications, RESET should be programmed active Low. This document describes the pin as  $\overline{RESET/OE}$ .

### $\overline{CE}$

Chip Enable input (active Low). A Low level (with OE High) allows CLK to increment the address counter and enables the data output driver. A High level on  $\overline{CE}$  disables both the address and bit counters and forces the device into a low-power standby mode. Note that this pin will *not* enable/disable the device in the Two-Wire Serial Programming mode ( $\overline{SER\_EN}$  Low).

### GND

Ground pin. A 0.2  $\mu$ F decoupling capacitor between V<sub>CC</sub> and GND is recommended.

### VCC( $\overline{SER\_EN}$ )

Serial enable must be held High during FPGA loading operations. Bringing  $\overline{SER\_EN}$  Low enables the Two-Wire Serial Programming Mode. For non-ISP applications,  $\overline{SER\_EN}$  should be tied to V<sub>CC</sub>.

### V<sub>CC</sub>

3.3V ( $\pm 10\%$ ) Commercial and Industrial power supply pin.

### NC

NC pins are No Connect pins, which are not internally bonded out to the die.

### DC

DC pins are No Connect pins internally connected to the die. It is not recommended to connect these pins to any external signal.



## FPGA Master Serial Mode Summary

The I/O and logic functions of any SRAM-based FPGA are established by a configuration program. The program is loaded either automatically upon power-up, or on command, depending on the state of the FPGA mode pins. In Master mode, the FPGA automatically loads the configuration program from an external memory. The AT17N Serial Configuration EEPROM has been designed for compatibility with the Master Serial mode.

This document discusses the master serial mode configuration of Atmel AT17N series configuration memories, pin compatible with Spartan-II, Spartan-IIe and Spartan XL OTP PROMs.

## Control of Configuration

Most connections between the FPGA device and the AT17N Serial EEPROM are simple and self-explanatory.

- The DATA output of the AT17N series configurator drives DIN of the FPGA devices.
- The master FPGA CCLK output drives the CLK input of the AT17N series configurator.
- $\overline{\text{SER\_EN}}$  must be connected to  $V_{CC}$  (except during ISP).
- The  $\overline{\text{CE}}$  and  $\text{OE}/\overline{\text{Reset}}$  are driven by the FPGA to enable output data buffer of the EEPROM.

## Programming Mode

The programming mode is entered by bringing  $\overline{\text{SER\_EN}}$  Low. In this mode the chip can be programmed by the Two-Wire serial bus. The programming is done at  $V_{CC}$  supply only. Programming super voltages are generated inside the chip.

## Standby Mode

The AT17N series configurators enter a low-power standby mode whenever  $\overline{\text{CE}}$  is asserted High. In this mode, the AT17N256 configurator consumes less than 50  $\mu\text{A}$  of current at 3.3V (100  $\mu\text{A}$  for the AT17N512/010 and 200  $\mu\text{A}$  for the AT17N002/040).

### Absolute Maximum Ratings\*

Operating Temperature .....	-40°C to +85°C
Storage Temperature .....	-65°C to +150°C
Voltage on Any Pin with Respect to Ground .....	-0.1V to $V_{CC} + 0.5V$
Supply Voltage ( $V_{CC}$ ) .....	3.0V to +3.6V
Maximum Soldering Temp. (10 sec. @ 1/16 in.).....	260°C
ESD ( $R_{ZAP} = 1.5K, C_{ZAP} = 100 \text{ pF}$ ).....	2000V

\*NOTICE: Stresses beyond those listed under Absolute Maximum Ratings may cause permanent damage to the device. This is a stress rating only and functional operation of the device at these or any other conditions beyond those listed under operating conditions is not implied. Exposure to Absolute Maximum Rating conditions for extended periods of time may affect device reliability.

### Operating Conditions

Symbol	Description	3.3V		Units	
		Min	Max		
$V_{CC}$	Commercial	Supply voltage relative to GND -0°C to +70°C	3.0	3.6	V
	Industrial	Supply voltage relative to GND -40°C to +85°C	3.0	3.6	V





## DC Characteristics

$V_{CC} = 3.3V \pm 10\%$

Symbol	Description	AT17N256		AT17N512/ AT17N010		AT17N002/ AT17N040		Units	
		Min	Max	Min	Max	Min	Max		
$V_{IH}$	High-level Input Voltage	2.0	$V_{CC}$	2.0	$V_{CC}$	2.0	$V_{CC}$	V	
$V_{IL}$	Low-level Input Voltage	0	0.8	0	0.8	0	0.8	V	
$V_{OH}$	High-level Output Voltage ( $I_{OH} = -2.5$ mA)	Commercial	2.4	2.4	2.4	2.4	2.4	V	
$V_{OL}$	Low-level Output Voltage ( $I_{OL} = +3$ mA)		0.4					0.4	0.4
$V_{OH}$	High-level Output Voltage ( $I_{OH} = -2$ mA)	Industrial	2.4	2.4	2.4	2.4	2.4	V	
$V_{OL}$	Low-level Output Voltage ( $I_{OL} = +3$ mA)		0.4					0.4	0.4
$I_{CCA}$	Supply Current, Active Mode		5		5		5	mA	
$I_L$	Input or Output Leakage Current ( $V_{IN} = V_{CC}$ or GND)		-10	10	-10	10	-10	10	$\mu$ A
$I_{CCS}$	Supply Current, Standby Mode	Commercial		50		100		150	$\mu$ A
		Industrial		100		100		150	$\mu$ A

## AC Characteristics

$V_{CC} = 3.3V \pm 10\%$

Symbol	Description	AT17N256				AT17N512/010/002/040				Units
		Commercial		Industrial		Commercial		Industrial		
		Min	Max	Min	Max	Min	Max	Min	Max	
$T_{OE}^{(1)}$	OE to Data Delay		50		55		50		55	ns
$T_{CE}^{(1)}$	$\overline{CE}$ to Data Delay		60		60		55		60	ns
$T_{CAC}^{(1)}$	CLK to Data Delay		75		80		55		60	ns
$T_{OH}$	Data Hold from $\overline{CE}$ , OE, or CLK	0		0		0		0		ns
$T_{DF}^{(2)}$	$\overline{CE}$ or OE to Data Float Delay		55		55		50		50	ns
$T_{LC}$	CLK Low Time	25		25		25		25		ns
$T_{HC}$	CLK High Time	25		25		25		25		ns
$T_{SCE}$	$\overline{CE}$ Setup Time to CLK (to guarantee proper counting)	35		60		30		35		ns
$T_{HCE}$	$\overline{CE}$ Hold Time from CLK (to guarantee proper counting)	0		0		0		0		ns
$T_{HOE}$	OE High Time (guarantees counter is reset)	25		25		25		25		ns
$F_{MAX}$	Maximum Clock Frequency		10		10		15		10	MHz

- Notes: 1. AC test lead = 50 pF.  
2. Float delays are measured with 5 pF AC loads. Transition is measured  $\pm 200$  mV from steady-state active levels.

AC Characteristics

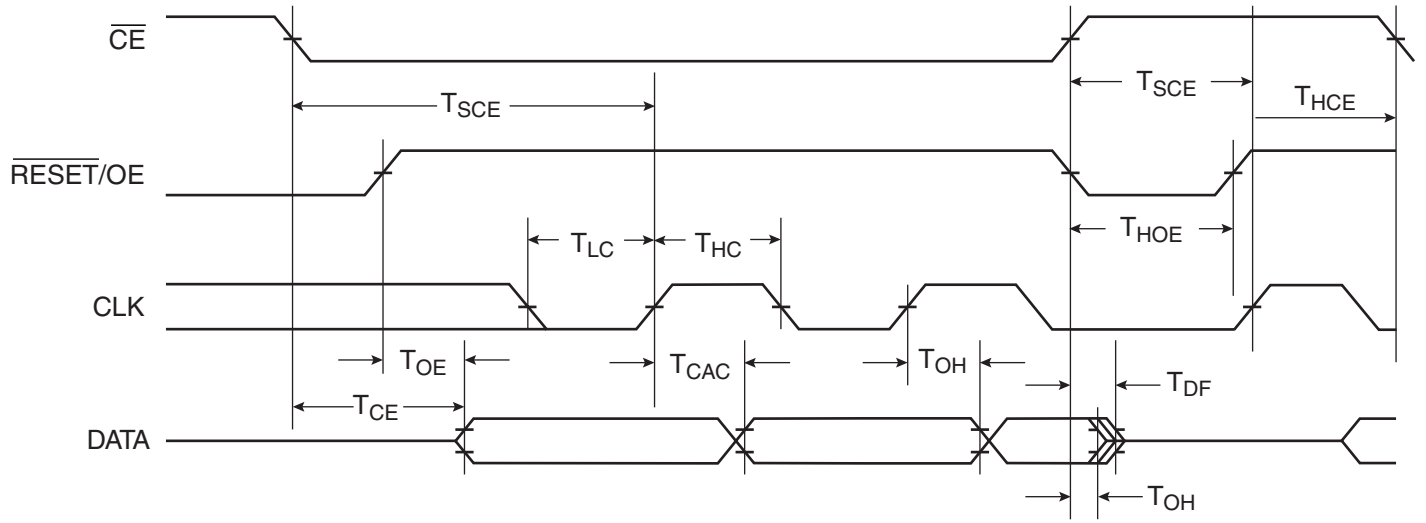

## Thermal Resistance Coefficients<sup>(1)</sup>

Package Type			AT17N256	AT17N512/ AT17N010	AT17N002	AT17N040
8P3	Plastic Dual Inline Package (PDIP)	$\theta_{JC}$ [ $^{\circ}\text{C}/\text{W}$ ]	37	37	–	–
		$\theta_{JA}$ [ $^{\circ}\text{C}/\text{W}$ ] <sup>(2)</sup>	107	107	–	–
8S1	Plastic Gull Wing Small Outline (SOIC)	$\theta_{JC}$ [ $^{\circ}\text{C}/\text{W}$ ]	45	–	–	–
		$\theta_{JA}$ [ $^{\circ}\text{C}/\text{W}$ ] <sup>(2)</sup>	150	–	–	–
20S2	Plastic Gull Wing Small Outline (SOIC)	$\theta_{JC}$ [ $^{\circ}\text{C}/\text{W}$ ]				–
		$\theta_{JA}$ [ $^{\circ}\text{C}/\text{W}$ ] <sup>(2)</sup>				–
44A	Thin Plastic Quad Flat Package (TQFP)	$\theta_{JC}$ [ $^{\circ}\text{C}/\text{W}$ ]	–	–	17	17
		$\theta_{JA}$ [ $^{\circ}\text{C}/\text{W}$ ] <sup>(2)</sup>	–	–	62	62

- Notes: 1. For more information refer to the “Thermal Characteristics of Atmel’s Packages”, available on the Atmel web site.  
 2. Airflow = 0 ft/min.

Figure 1. Ordering Code

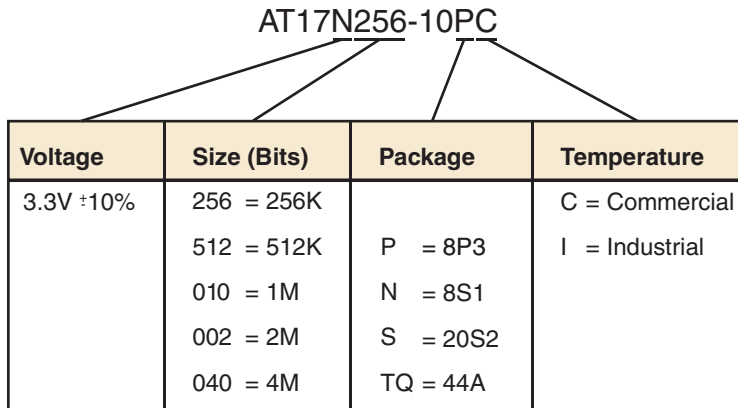

Package Type	
<b>8P3</b>	8-lead, 0.300" Wide, Plastic Dual Inline Package (PDIP)
<b>8S1</b>	8-lead, 0.150" Wide, Plastic Gull Wing Small Outline (JEDEC SOIC)
<b>20S2</b>	20-lead, 0.300" Wide, Plastic Gull Wing Small Outline (JEDEC SOIC)
<b>44A</b>	44-lead, Thin (1.0 mm) Plastic Quad Flat Package Carrier (TQFP)



## Ordering Information

Memory Size	Ordering Code	Package	Operation Range
256-Kbit	AT17N256-10PC	8P3	Commercial (0°C to 70°C)
	AT17N256-10NC	8S1	
	AT17N256-10SC	20S2	
	AT17N256-10PI	8P3	Industrial (-40°C to 85°C)
	AT17N256-10NI	8S1	
	AT17N256-10SI	20S2	
512-Kbit	AT17N512-10SC	20S2	Commercial (0°C to 70°C)
	AT17N512-10SI	20S2	Industrial (-40°C to 85°C)
1-Mbit	AT17N010-10SC	20S2	Commercial (0°C to 70°C)
	AT17N010-10SI	20S2	Industrial (-40°C to 85°C)
2-Mbit	AT17N002-10SC	20S2	Commercial (0°C to 70°C)
	AT17N002-10TQC	44A	
	AT17N002-10SI	20S2	Industrial (-40°C to 85°C)
	AT17N002-10TQI	44A	
4-Mbit	AT17N040-10TQC	44A	Commercial (0°C to 70°C)
	AT17N040-10TQI	44A	Industrial (-40°C to 85°C)

Notes: 1. For the -10CC and -10CI packages, customers may migrate to AT17LVXXX-10CU.

Packaging Information

8P3 – PDIP

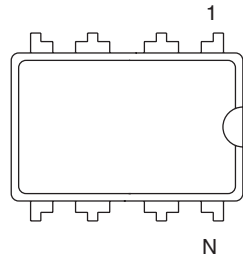

Top View

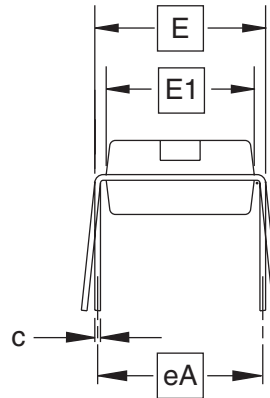

End View

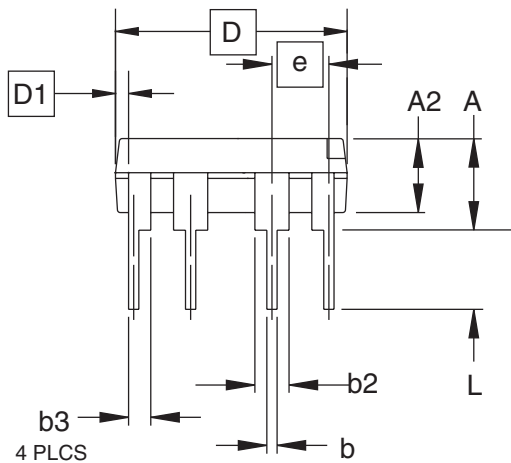

Side View

COMMON DIMENSIONS  
(Unit of Measure = inches)

SYMBOL	MIN	NOM	MAX	NOTE
A			0.210	2
A2	0.115	0.130	0.195	
b	0.014	0.018	0.022	5
b2	0.045	0.060	0.070	6
b3	0.030	0.039	0.045	6
c	0.008	0.010	0.014	
D	0.355	0.365	0.400	3
D1	0.005			3
E	0.300	0.310	0.325	4
E1	0.240	0.250	0.280	3
e	0.100 BSC			
eA	0.300 BSC			4
L	0.115	0.130	0.150	2

- Notes:
1. This drawing is for general information only; refer to JEDEC Drawing MS-001, Variation BA for additional information.
  2. Dimensions A and L are measured with the package seated in JEDEC seating plane Gauge GS-3.
  3. D, D1 and E1 dimensions do not include mold Flash or protrusions. Mold Flash or protrusions shall not exceed 0.010 inch.
  4. E and eA measured with the leads constrained to be perpendicular to datum.
  5. Pointed or rounded lead tips are preferred to ease insertion.
  6. b2 and b3 maximum dimensions do not include Dambar protrusions. Dambar protrusions shall not exceed 0.010 (0.25 mm).

01/09/02



2325 Orchard Parkway  
San Jose, CA 95131

**TITLE**  
8P3, 8-lead, 0.300" Wide Body, Plastic Dual  
In-line Package (PDIP)

**DRAWING NO.**  
8P3

**REV.**  
B



8S1 – SOIC

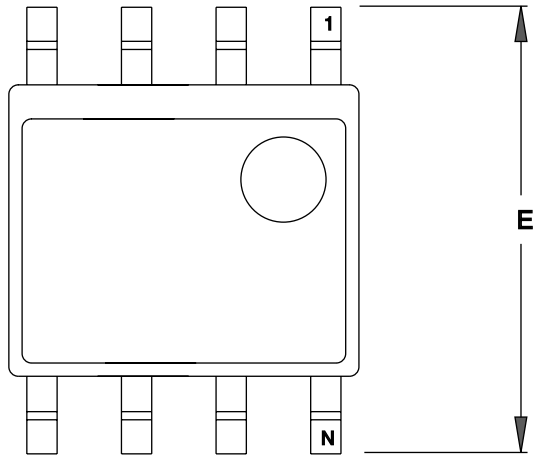

TOP VIEW

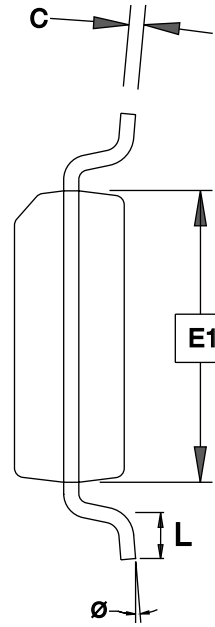

END VIEW

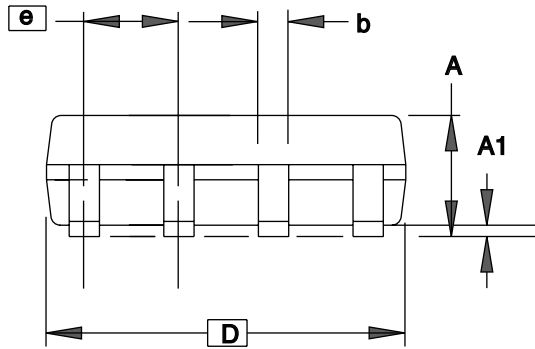

SIDE VIEW

COMMON DIMENSIONS  
(Unit of Measure = mm)

SYMBOL	MIN	NOM	MAX	NOTE
A	1.35	–	1.75	
A1	0.10	–	0.25	
b	0.31	–	0.51	
C	0.17	–	0.25	
D	4.80	–	5.05	
E1	3.81	–	3.99	
E	5.79	–	6.20	
e	1.27 BSC			
L	0.40	–	1.27	
$\theta$	0°	–	8°	

Note: These drawings are for general information only. Refer to JEDEC Drawing MS-012, Variation AA for proper dimensions, tolerances, datums, etc.

3/17/05



1150 E. Cheyenne Mtn. Blvd.  
Colorado Springs, CO 80906

**TITLE**  
8S1, 8-lead (0.150" Wide Body), Plastic Gull Wing  
Small Outline (JEDEC SOIC)

**DRAWING NO.**  
8S1

**REV.**  
C

20S2 – SOIC



# 44A – TQFP

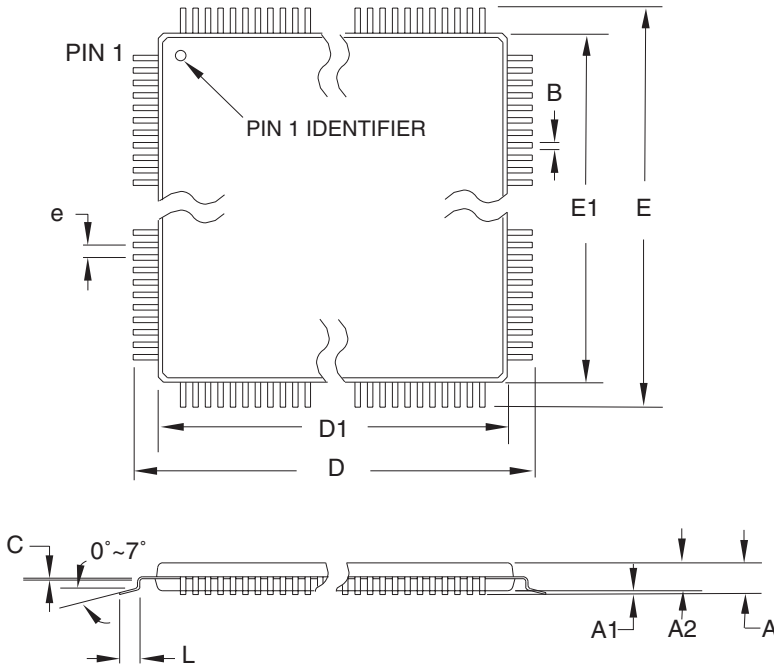

**COMMON DIMENSIONS**  
(Unit of Measure = mm)

SYMBOL	MIN	NOM	MAX	NOTE
A	–	–	1.20	
A1	0.05	–	0.15	
A2	0.95	1.00	1.05	
D	11.75	12.00	12.25	
D1	9.90	10.00	10.10	Note 2
E	11.75	12.00	12.25	
E1	9.90	10.00	10.10	Note 2
B	0.30	–	0.45	
C	0.09	–	0.20	
L	0.45	–	0.75	
e	0.80 TYP			

- Notes:
1. This package conforms to JEDEC reference MS-026, Variation ACB.
  2. Dimensions D1 and E1 do not include mold protrusion. Allowable protrusion is 0.25 mm per side. Dimensions D1 and E1 are maximum plastic body size dimensions including mold mismatch.
  3. Lead coplanarity is 0.10 mm maximum.

10/5/2001

2325 Orchard Parkway San Jose, CA 95131	<b>TITLE</b> <b>44A</b> , 44-lead, 10 x 10 mm Body Size, 1.0 mm Body Thickness, 0.8 mm Lead Pitch, Thin Profile Plastic Quad Flat Package (TQFP)	<b>DRAWING NO.</b>	<b>REV.</b>
		44A	B

## Revision History

Revision Level – Release Date	History
B – March 2006	Added last-time buy for AT17NXXX-10CC and AT17NXXX-10CI.
C – August 2007	Removed 8CN4 8-lead LAP package.



## Headquarters

---

**Atmel Corporation**  
2325 Orchard Parkway  
San Jose, CA 95131  
USA  
Tel: 1(408) 441-0311  
Fax: 1(408) 487-2600

## International

---

**Atmel Asia**  
Room 1219  
Chinachem Golden Plaza  
77 Mody Road Tsimshatsui  
East Kowloon  
Hong Kong  
Tel: (852) 2721-9778  
Fax: (852) 2722-1369

**Atmel Europe**  
Le Krebs  
8, Rue Jean-Pierre Timbaud  
BP 309  
78054 Saint-Quentin-en-  
Yvelines Cedex  
France  
Tel: (33) 1-30-60-70-00  
Fax: (33) 1-30-60-71-11

**Atmel Japan**  
9F, Tonetsu Shinkawa Bldg.  
1-24-8 Shinkawa  
Chuo-ku, Tokyo 104-0033  
Japan  
Tel: (81) 3-3523-3551  
Fax: (81) 3-3523-7581

## Product Contact

---

**Web Site**  
[www.atmel.com](http://www.atmel.com)

**Technical Support**  
[configurator@atmel.com](mailto:configurator@atmel.com)

**Sales Contact**  
[www.atmel.com/contacts](http://www.atmel.com/contacts)

**Literature Requests**  
[www.atmel.com/literature](http://www.atmel.com/literature)

---

**Disclaimer:** The information in this document is provided in connection with Atmel products. No license, express or implied, by estoppel or otherwise, to any intellectual property right is granted by this document or in connection with the sale of Atmel products. **EXCEPT AS SET FORTH IN ATMEL'S TERMS AND CONDITIONS OF SALE LOCATED ON ATMEL'S WEB SITE, ATMEL ASSUMES NO LIABILITY WHATSOEVER AND DISCLAIMS ANY EXPRESS, IMPLIED OR STATUTORY WARRANTY RELATING TO ITS PRODUCTS INCLUDING, BUT NOT LIMITED TO, THE IMPLIED WARRANTY OF MERCHANTABILITY, FITNESS FOR A PARTICULAR PURPOSE, OR NON-INFRINGEMENT. IN NO EVENT SHALL ATMEL BE LIABLE FOR ANY DIRECT, INDIRECT, CONSEQUENTIAL, PUNITIVE, SPECIAL OR INCIDENTAL DAMAGES (INCLUDING, WITHOUT LIMITATION, DAMAGES FOR LOSS OF PROFITS, BUSINESS INTERRUPTION, OR LOSS OF INFORMATION) ARISING OUT OF THE USE OR INABILITY TO USE THIS DOCUMENT, EVEN IF ATMEL HAS BEEN ADVISED OF THE POSSIBILITY OF SUCH DAMAGES.** Atmel makes no representations or warranties with respect to the accuracy or completeness of the contents of this document and reserves the right to make changes to specifications and product descriptions at any time without notice. Atmel does not make any commitment to update the information contained herein. Unless specifically provided otherwise, Atmel products are not suitable for, and shall not be used in, automotive applications. Atmel's products are not intended, authorized, or warranted for use as components in applications intended to support or sustain life.

© Atmel Corporation 2007. All rights reserved. Atmel®, logo and combinations thereof, Everywhere You Are® and others are registered trademarks or trademarks of Atmel Corporation or its subsidiaries. FLEX™ is the trademark of Altera Corporation; ORCA™ is the trademark of Lattice Semiconductors; SPARTAN® and Virtex® are the registered trademarks of Xilinx, Inc.; XC3000™, XC4000™ and XC5200™ are the trademarks of Xilinx, Inc.; APEX™ is the trademark of MIPS Technologies; Other terms and product names may be the trademarks of others.