



Chipsmall Limited consists of a professional team with an average of over 10 year of expertise in the distribution of electronic components. Based in Hongkong, we have already established firm and mutual-benefit business relationships with customers from,Europe,America and south Asia,supplying obsolete and hard-to-find components to meet their specific needs.

With the principle of “Quality Parts,Customers Priority,Honest Operation,and Considerate Service”,our business mainly focus on the distribution of electronic components. Line cards we deal with include Microchip,ALPS,ROHM,Xilinx,Pulse,ON,Everlight and Freescale. Main products comprise IC,Modules,Potentiometer,IC Socket,Relay,Connector.Our parts cover such applications as commercial,industrial, and automotives areas.

We are looking forward to setting up business relationship with you and hope to provide you with the best service and solution. Let us make a better world for our industry!



## Contact us

Tel: +86-755-8981 8866 Fax: +86-755-8427 6832

Email & Skype: info@chipsmall.com Web: www.chipsmall.com

Address: A1208, Overseas Decoration Building, #122 Zhenhua RD., Futian, Shenzhen, China



---

**Atmel ATA6616-EK/ATA6617-EK Development Board V1.1**

---

**ATA6616-EK/ATA6617-EK**

---

**Introduction**

---

The development board for the Atmel® ATA6616/ATA6617 ICs enables users to rapidly prototyping and testing of new LIN designs on the Atmel ATA6616 and Atmel ATA6617 ICs.

**Figure 1. Atmel ATA6616-EK/ATA6617-EK Development Board**



The Atmel ATA6616 and Atmel ATA6617 are dual-chip System-in-Package (SIP) products especially well suited for complete LIN-bus slave and master node applications supporting highly integrated in-vehicle LIN networking solutions. The first chip of the dual-chip SIP is the Atmel LIN System Basis Chip (LIN SBC) Atmel ATA6624 with an integrated 5V voltage regulator, a window watchdog, and a fully integrated LIN transceiver complying with the LIN 2.1 specification. The second chip is an automotive microcontroller within the Atmel AVR® 8-bit microcontroller series with advanced RISC architecture (Atmel ATtiny87 with 8K flash in Atmel ATA6616 and the Atmel ATtiny167 with 16K flash in Atmel ATA6617). All pins of both integrated chips are bonded out to provide customers with the same flexibility for their applications which they have when using discrete parts. There is no internal connection between the two chips.

The supplied LIN SBC Atmel® ATA6624 has the following features:

- Master and slave operation possible
- Supply voltage up to 40V
- Operating voltage  $V_S = 5V$  to 27V
- Typically 10 $\mu$ A supply current during Sleep Mode ( $V_{CC}$  is switched off)
- Typically 40 $\mu$ A supply current in Silent Mode
- Linear low-drop voltage regulator 5V, 85mA current capability
- VCC undervoltage detection (4ms reset time) and watchdog reset logically combined at NRES
- Open drain output voltage regulator, boosting possible with external NPN transistor
- LIN physical layer complies with LIN 2.1 specification and SAE J2602-2
- Wake-up capability via LIN bus, WAKE pin, or KI\_15 pin
- INH output for external voltage regulator control or for switching off master pull-up resistor
- TXD time-out timer
- Bus pin is overtemperature and short circuit protected versus GND and battery
- Adjustable watchdog time via external resistor

The supplied AVR® (Atmel ATtiny87 or Atmel ATtiny167) has the following features:

- 8/16Kbytes of in-system programmable flash with read-while-write capabilities
- 512bytes EEPROM
- 512bytes SRAM
- 16 general purpose I/O lines
- 32 general purpose working registers
- Internal 8MHz RC oscillator calibrated for 5V at 25°C
- Two flexible timer/counters with compare modes
- Internal and external interrupts
- LIN 2.1 and LIN 1.3 controller or 8-bit UART
- Byte-oriented two-wire serial interface
- Master/slave SPI serial interface
- 4-channel 10-bit ADC
- Five software-selectable power-saving modes:
  - Idle Mode stops the CPU while allowing the SRAM, timer/counters, ADC, analog comparator and interrupt system to continue functioning.
  - Power-down Mode saves the register contents but freezes the oscillator, disabling all other chip functions until the next interrupt or hardware reset.
  - Power-save Mode: the asynchronous timer continues to run, allowing the user to maintain a timer base while the rest of the device is sleeping.
  - ADC Noise Reduction Mode stops the CPU and all I/O modules except ADC, minimizing switching noise during ADC conversions.
  - Standby Mode: the crystal/resonator oscillator runs while the rest of the device is sleeping. This allows very fast start-up while limiting power consumption.



The combination of the features included in Atmel® ATA6616/ATA6617 makes it possible to develop simple, but powerful and cheap slave nodes in LIN bus systems.

The ICs are designed to handle low-speed data communication in vehicles (such as in convenience electronics). Improved slope control at the LIN driver ensures secure data communication up to 20kBaud. Sleep and Silent Mode included in the LIN SBC guarantee very low current consumption.

The Atmel ATA6616 and Atmel ATA6617 are full pin- and functional-compatible. They only differ in the size of integrated microcontroller flash memory. Some minor modifications in the source code when switching between Atmel ATA6616 and Atmel ATA6617 during the development phase may be required.

Because a standard AVR® microcontroller with all pins is included with the Atmel ATA6616 and Atmel ATA6617, the standard toolchain consisting of the Atmel AVR Studio®, front-end assembler and simulator, and in-circuit emulator can be used in new application development and debugging. Furthermore, ActiveX components are also available that can be used to create a simple PC program for emulation of the LIN master node. Using the software components and the development board, it is very easy and inexpensive to create and test a LIN network.

Unlike standalone AVRs, the internal 8MHz RC oscillator has been calibrated at 5V and, therefore, perfectly fits the output voltage of the integrated voltage regulator.

This document provides users with start-up information about the Atmel ATA6616 and Atmel ATA6617's development board. Please refer to the corresponding datasheet For more detailed information about using the devices themselves.

# 1. Development Board Features

The development board for the Atmel ATA6616/ATA6617 IC supports the following features:

- All components necessary to put the ATA6616/ATA6617 into operation are included
- Placeholders for some optional components for extended functions included
- All pins easily accessible
- Easily adaptable watchdog times by replacing a single resistor
- Optional activation of external NPN transistor for boosting output current of voltage regulator (removing jumper JP3)
- Choice of master or slave operation (mounting D2 and R1)
- Optional external quartz mounted for handling time-critical applications (not necessary for LIN communication)
- Push button included for creating local wake-up after entering Sleep or Silent Mode
- Ground coultler clip for easy probe connection while measuring with oscilloscope

# 2. Quick Start

The development board for the Atmel® ATA6616/ATA6617 is shipped with the default jumper settings and all accessories required for immediate use.

**Figure 2-1. Atmel ATA6616/ATA6617 Development Board with Reference Points**

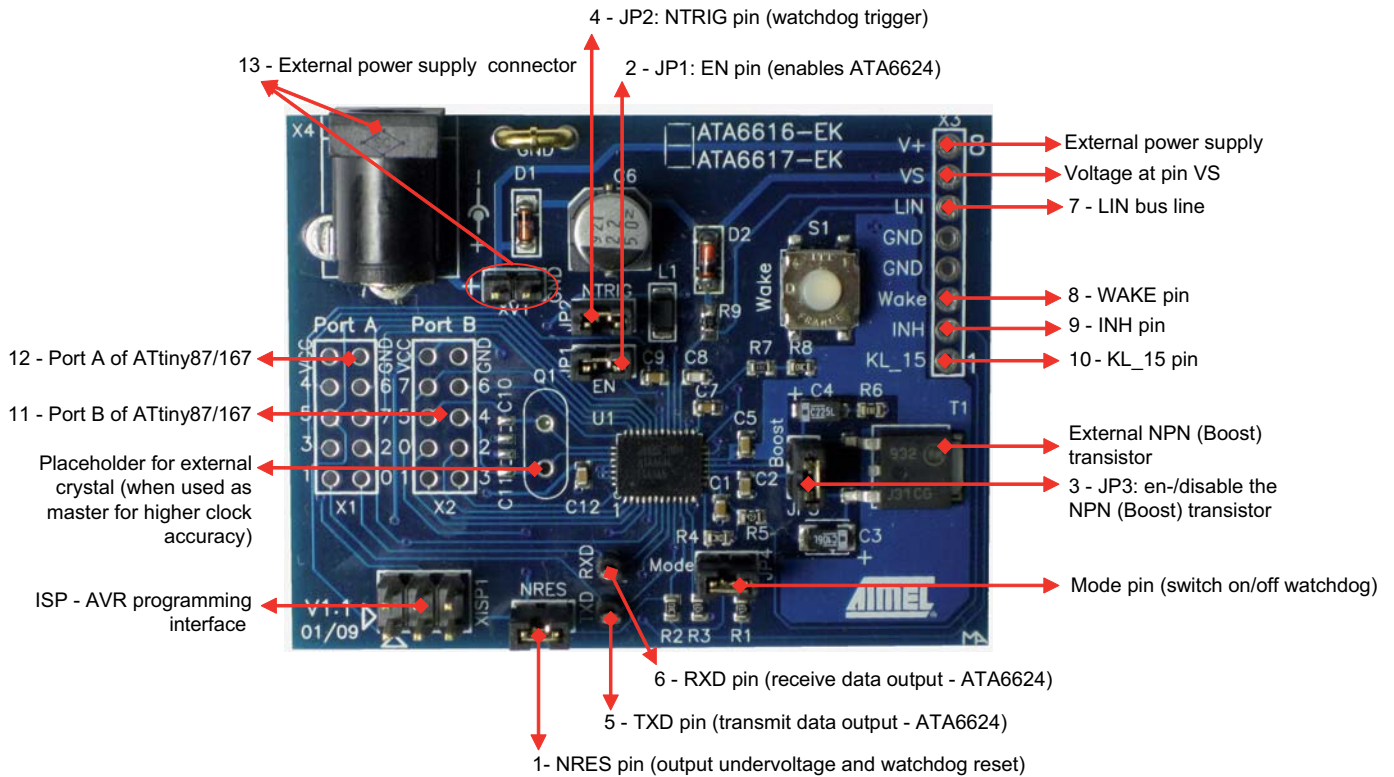

The IC mounted on the board is pre-programmed with a firmware to allow testing and interpretation of basic functions directly on the board. After correctly connecting an external 12V DC power supply to the power connector or between the terminals “+” and “-” (reference point 13), the LIN SBC is in Fail-safe Mode. After the power is supplied to the microcontroller (regulated 5V DC voltage provided by the LIN SBC’s internal voltage regulator), the microcontroller switches the LIN SBC to Normal Mode by setting the EN pin to high (ENABLE jumper) and starts to trigger the integrated window watchdog. The system is now ready for data transmission via the LIN bus. Signals fed in at the TXD pin are visible on the LIN bus while signals on the LIN bus are visible at the RXD pin. In Normal Mode the current consumption is approximately 3mA and the following voltages and signals can be seen at the corresponding pins.

**Table 2-1. Overview of Pin Status at Start-up of the Development Board**

Test Point	Expected Behavior	Additional Information	Symbol
NRES Jumper	5V DC		1
EN Jumper	5V DC		2
Boost Jumper	5V DC		3
NTRIG Jumper	Frequency $f \approx 36.6\text{Hz}$	$V_{pp} = 5\text{V}$	4
TXD	Frequency $f \approx 36.6\text{Hz}$	$V_{pp} = 5\text{V}$	5
RXD	Frequency $f \approx 36.6\text{Hz}$	$V_{pp} = 5\text{V}$	6
LIN	Frequency $f \approx 36.6\text{Hz}$	$V_{pp} \approx 11\text{V}$	7
WAKE	$\sim 11.2\text{V DC}$		8
INH	$\sim 11.2\text{V DC}$		9
KL15	0V DC		10
PB0 to PB6	Frequency $f \approx 36.6\text{Hz}$	$V_{pp} = 5\text{V}$	11
PB7	5V DC		
PA0 to PA3, PA5 to PA7	Frequency $f \approx 36.6\text{Hz}$	$V_{pp} = 5\text{V}$	12
PA4	5V DC		12

The board’s pre-programmed firmware provides the window watchdog with a valid trigger signal so that the NRES pin is not forced to ground and the microcontroller does not receive any resets.

For testing purposes and for system interpretation, it may be useful to view behavior while the watchdog is not correctly triggered. This can be achieved in two different ways without changing the firmware of the IC:

- Remove NTRIG jumper  
No trigger signal reaches the watchdog and the watchdog generates a reset directly after lead time of  $t_d(51\text{k}\Omega) = 49\text{ms}$  expires.
- Re-program the fuse bit  
Changing the fuse bit CKDIV8 to unprogrammed changes the microcontroller’s internal clock from 1MHz to 8MHz. Doing this keeps the trigger signal generated from the microcontroller from meeting the open window from the window watchdog and a reset is thus generated.

## 3. Hardware Description

### 3.1 Pin Description

In the following sections the external elements required for some of the pins are shown and described. Please see the specific datasheet for more information about this topic, refer to the relevant datasheet.

#### 3.1.1 Power Supply

In order to get the development board running, an external 5.7V to 18.7V DC power supply has to be connected to the power connector (positive center connector) or to the terminals "+" and "-" directly on the right side of the power connector. The input circuit is protected against inversepolarity by the protection diode D1, resulting in a difference of approximately 0.7V between the supply voltage VBat and the VS pin voltage.

#### 3.1.2 Voltage Regulator (PVCC and VCC)

The internal 5V voltage regulator is capable of driving loads with up to 85mA current consumption. The Atmel® ATA6616 and Atmel ATA6617 are therefore able to supply the internal microcontroller, some external sensors, and/or other ICs required for the LIN node in question. The voltage regulator is protected against overloads by means of current limitation and overtemperature shutdown. To boost the maximum load current, an external NPN transistor may be used (please see ["Boosting Up the Voltage Regulator" on page 15](#) for more information). Its base is connected to the VCC pin and its emitter is connected to PVCC. To enable this feature, the jumper JP3, which connects the two pins PVCC and VCC per default, has to be removed. Please note that the PVCC voltage is no longer short-circuit protected when an external NPN-transistor is used to boost up the output current.

As for the most applications the 85mA are sufficient, the Jumper PVCC is set per default.

#### 3.1.3 The Window Watchdog (NTRIG, WD\_OSC and NRES)

The watchdog anticipates a trigger signal from the microcontroller at the NTRIG input (negative edge) within a defined time window. If no correct trigger signal is received during the open window, a reset signal (active low) is generated at the NRES output. During Silent or Sleep Mode the watchdog is switched off to reduce current consumption.

The timing basis of the watchdog is provided by the internal oscillator, whose time period  $t_{OSC}$  can be adjusted via the external resistor R3 at the WD\_OSC pin. All watchdog-specific timings ( $t_1$ ,  $t_2$ ,  $t_d$ , ...) are based on the value of this resistor. As a default a resistor with a value of 51k $\Omega$  is mounted on the development board, resulting in the following timing sequence for the integrated watchdog.

Figure 3-1. Watchdog Timing Sequence with R3 = 51k $\Omega$

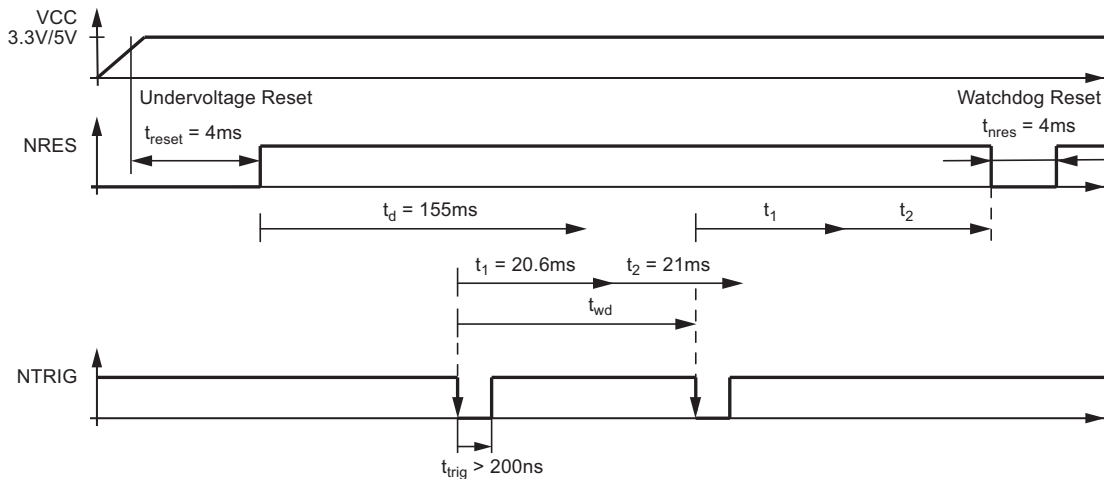

The microcontroller pin PA3 is used per default to trigger the watchdog. In order to guide the signals generated from pin PA3 to the watchdog trigger input NTRIG, the jumper JP2 has to be set. If it is not possible to use the pin PA3 to trigger the watchdog because it is being used for another function, remove the JP2 jumper and connect the NTRIG pin directly to another microcontroller pin using a 1-wire cable.

If the watchdog is not used, the trigger input can be left open on the development board, because it is equipped with an internal pull-up resistor. For normal use of the Atmel® ATA6616 and Atmel ATA6617 with deactivated watchdog, the trigger input pin NTRIG should be connected directly to VCC for EMC reasons.

Replacing the resistor R3 changes the frequency of the internal oscillator, causing a corresponding change in the watchdog timing. The following formula shows how the frequency of the internal oscillator depends on the value of the resistor R3. For more information, please refer also to the Atmel ATA6616/ATA6617 datasheet:

$$t_{\text{OSC}} [R_{\text{WD\_OSC}}] = -0.0004 \times (R_{\text{WD\_OSC}})^2 + 0.405 \times R_{\text{WD\_OSC}}$$

$t_{\text{OSC}}$  in  $\mu\text{s}$

$R_{\text{WD\_OSC}}$  in  $\text{k}\Omega$

With the values given in the datasheet, all relevant watchdog times can be calculated (for example, the open window and the closed window) using  $t_{\text{OSC}}$ .

In general, both Atmel ATA6616 and Atmel ATA6617 are shipped with an oscillator start-up time of 65ms. Due to the extra-long lead time of 155ms in almost all cases it should be possible to meet the first open window of the watchdog. If more time is needed, the default start-up time of the microcontroller 65ms can be reduced via the fuse bits to 4.1ms or even 0ms. The IC mounted on the board is delivered with a start-up time of 65ms.

### 3.1.4 LIN Interface (LIN, TXD and RXD)

The LIN Transceiver is only active when the LIN SBC is in Normal Mode. In all other modes the transceiver is switched off and no signals from the microcontroller are transmitted on the bus and no signals from the bus are passed to the microcontroller.

Because the two pins TXD and RXD on the LIN SBC are controlled by the microcontroller's LIN/UART, they are connected to the corresponding TXD and RXD pins on the microcontroller and can be monitored at these pins, with test points supplied on the development board.

#### 3.1.4.1 LIN Pin (LIN SBC)

A low-side driver with internal current limitation and thermal shutdown and an internal pull-up resistor in compliance with LIN specification 2.1 are implemented. The LIN receiver thresholds are compatible with the LIN protocol specification.

When using the development board for a LIN master application, it is possible to mount the two required extra components diode D2 (e.g., LL4148) in series with resistor R9 (1k $\Omega$ ) on the board at their designated placeholders.

#### 3.1.4.2 TXD Input/Output Pin (LIN SBC)

The signals sent to the TXD input pin control the state of the LIN output. The TXD input pin must be pulled to ground in order to drive the LIN bus low. If the TXD is high, the LIN output transistor is turned off and the bus is in recessive state, pulled up by the internal/external resistor. If the TXD is low, the LIN output transistor is turned on and the bus is in dominant state. An internal timer prevents the bus line from being driven permanently in the dominant state. If TXD is forced to low longer than  $t_{\text{DOM\_min}} > 6\text{ms}$ , the LIN SBC internally switches the TXD state to high and the LIN bus driver is switched to the recessive state.

This feature is used to prevent a single faulty slave node or a short to ground at the TXD pin from paralyzing communication on the complete LIN bus to which the faulty slave node is connected. Due to this behavior, the internal state of the TXD pin can differ from the signal level visible at the pin itself. However, if TXD is short-circuited to GND, it is possible to switch to Sleep Mode via ENABLE after  $t_{\text{DOM\_max}} > 20\text{ms}$ .



### 3.1.4.3 TXD Input/Output Pin (Microcontroller)

The TXD pin from the microcontroller (PA1) which is part of the LIN/UART hardware is hard-wired to the TXD input pin from the LIN SBC.

Because the LIN SBC indicates the wake-up source (local wake-up or remote wake-up) with the help of the TXD pin, it is recommended that the TXD pin from the microcontroller be reconfigured as an input when entering Silent or Sleep Mode. As long as pin EN is still low after a wake-up, the LIN SBC indicates the wake-up source at the TXD pin.

### 3.1.4.4 RXD Output Pin (LIN SBC)

This pin reports the state of the LIN bus to the microcontroller. LIN high (recessive state) is reported by a high level at RXD; LIN low (dominant state) is reported by a low level at RXD. The output has an internal pull-up structure with typically 5k $\Omega$  to VCC.

This output is short-circuit protected.

The RXD pin from the microcontroller (PA0) which is part of the LIN/UART hardware is hard-wired to the RXD input pin from the LIN SBC and the current state of this pin can be monitored at a supplied test point.

### 3.1.5 INH Pin (LIN SBC)

A 85mA current supply is sufficient for most LIN node applications. However, if more current is needed, the INH output can be used to switch on an additional, external voltage regulator during Normal or Fail-safe Mode. The INH pin is automatically switched off in Sleep or Silent Mode. In addition to switching an external voltage regulator, the INH output can also be used to switch application-specific circuit parts in order to minimize current consumption during Sleep or Silent Mode.

### 3.1.6 WAKE (LIN SBC)

The high-voltage input pin WAKE can be used to generate a local (low-active) wake-up from Sleep or Silent Mode. A push button is provided at this pin on the development board. If a local wake-up is not required in the application, the WAKE pin should be connected to VS. In this case the two resistors R7 and R8 need to be replaced by 0 $\Omega$  resistors.

### 3.1.7 KL\_15 (LIN SBC)

In addition to the WAKE pin, there is another way to generate a local wake-up: the KL\_15 pin. Like the WAKE pin, the KL\_15 pin is also a high-voltage input. However, it is edge sensitive and is activated on a low-to-high transition. It can be connected to the ignition of the car in order to generate local application wake-up when the ignition is switched on. To protect this pin against voltage transients a serial resistor of 47k $\Omega$  and a ceramic capacitance of 100nF are recommended. If this wake-up option is not used in an application, this pin should be connected directly to ground.

### 3.1.8 MODE Pin (LIN SBC) and Debug Mode

During the early development phase it can be helpful to deactivate the watchdog so that no resets disturb the normal application program. It is highly recommended to use "Debug Mode" during the development phase only, because the watchdog is an important safety feature for most automotive applications.

On the development board the MODE pin is pulled to ground via the 10k $\Omega$  resistor R4. The watchdog is thus active during the LIN SBC Normal Mode or Fail-safe Mode. Setting the MODE jumper ties the MODE pin to 5V and disables the watchdog. If the watchdog is disabled, the other reset sources (undervoltage reset and after power-up) remain active. In order to avoid all resets of the microcontroller during debugging, deactivate the watchdog by removing the NRES jumper and mounting the MODE jumper.

Please note that if the NRES jumper has been removed and an undervoltage or watchdog failure occurs, the LIN SBC switches to Fail-safe Mode regardless of whether the microcontroller has been reset or not. In this case, the LIN transceiver is deactivated as long as the reset line is low.

### 3.1.9 NRES Output Pin (LIN SBC) and PB7/NRES Input Pin (Microcontroller)

The NRES output pin is an open-drain output and therefore requires an external pull-up resistor to VCC. The PB7/NRES input pin already has a pull-up resistor included with resistance between 30kΩ and 60kΩ. The NRES output pin of the LIN SBC is connected to the NRES input pin (PB6) of the microcontroller via the “NRES - JP5” jumper. For normal operation, this jumper has to be set so that a reset signal generated from the LIN SBC resets the microcontroller. Removing this jumper would lead to an undefined value at the NRES output pin. An additional 10kΩ resistor has been provided on the development board.

Because the NRES output is an open-drain output, it is not necessary to remove the jumper NRES while programming or debugging the device.

### 3.1.10 PB4 and PB5 (Microcontroller)

The microcontroller runs on an internal RC oscillator with a default frequency of 1MHz. Because the accuracy of the internal clock is sufficient for LIN communication, in most cases there is no need for higher accuracy. However, for some applications a more accurate clock is required and therefore an external crystal oscillator can be mounted on the development board at the designated Q1 placeholder together with the required C10 and C11 capacitors (see also “Running the Microcontroller on External Clock”). Please note that the fuse bit setting has to be changed when activating the external clock. For more information about how to change the fuse bits and information on using an external clock, refer to the datasheet of the Atmel® ATA6616/ATA6617 and to the Atmel AVR Studio® documentation.

If no external clock is used, the two pins PB4 and PB5 can be used as normal I/O pins without any restriction.

### 3.1.11 Other Pins

All others pins not described in this section have no special external circuitry and/or are used as described within the datasheet.

### 3.1.12 Summary of the Pin-Connection

As already described in detail in the previous sections, there are some pins tied together on the development board. A summary of the hard-wired pins on the Atmel ATA6616-EK/ATA6617-EK is shown in [Table 3-1](#).

**Table 3-1. Summary of the Hard-wired Pins on the Atmel ATA6616-EK/ATA6617-EK**

Microcontroller Pin	Connected to LIN SBC Pin
<b>PB7/NRES</b>	<b>NRES</b>
<b>PA3</b>	<b>NTRIG</b>
<b>PA4</b>	<b>EN</b>
<b>PA1</b>	<b>TXD</b>
<b>PA0</b>	<b>RXD</b>

The three connections marked in bold are generated via jumpers and the other two connections are hard-wired and equipped with a test point for ease of access.

## 3.2 Port Connectors

The Atmel ATA6616-EK/ATA6617-EK has two port connectors for the Port A and Port B microcontroller ports. All non-reserved I/O pins available from the microcontroller are routed to the corresponding connectors to ensure the user has easy access to them. In addition to the port pins, both connectors provide a voltage supply pin (5V from the internal voltage regulator) and a ground pin to facilitate connection of application-specific add-ons.

The pinouts of the two connectors are shown in [Figure 3-2](#).

**Figure 3-2. Pinout of the Port Connectors**

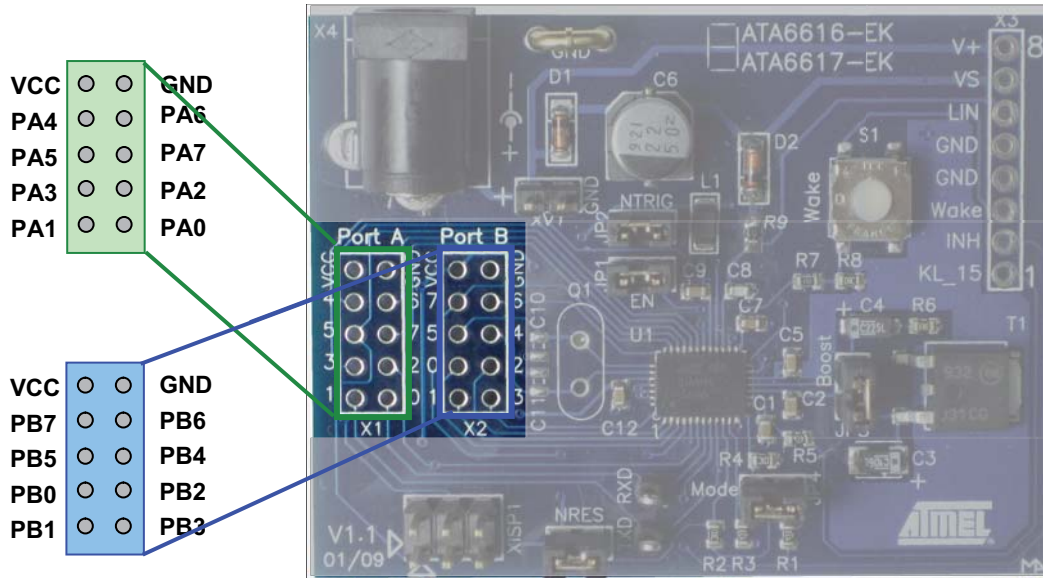

## 3.3 Jumper Description

In order to allow greater flexibility and meet as many requirements as possible, some jumpers are provided on the development board. With the help of these jumpers, users have the opportunity to interact with the system itself in order to test some features and/or to adapt the system to their requirements. In the following sections all jumpers on the development board are briefly described. For additional information, check the previous sections.

### 3.3.1 NRES Jumper – JP5

The default setting for the jumper connects the NRES output of the LIN SBC and the reset input of the microcontroller. This means the microcontroller will be reset if the watchdog fails or if there is undervoltage at the voltage regulator output. As described earlier in this document, there may be some cases when it is helpful to remove this jumper (e.g., testing purposes, debugging). However, for normal operation of the LIN node, this jumper should be set.

### 3.3.2 NTRIG Jumper – JP2

The default setting for the jumper connects the watchdog trigger signal output pin PA3 of the microcontroller and the watchdog trigger signal input pin NTRIG of the LIN SBC. If the PA3 pin is used for alternative functions in the application, the NTRIG (JP2) jumper can be completely removed, making the PA3 pin accessible. In this case, the watchdog has to be triggered by another I/O pin from the microcontroller, and the connection to the trigger input has to be made via an extra 1-wire cable.

### 3.3.3 MODE Jumper – JP4

By default this jumper is removed to apply a low-level at the MODE pin of the LIN SBC via the pull-down resistor R4. In this case, the LIN SBC's watchdog is active and expects trigger pulses from the microcontroller.

When debugging an application, it is often useful to deactivate the watchdog in order to get no resets, such as while at a break point. In this case the MODE jumper has to be set, which applies a high level at the MODE pin. From now on the watchdog is deactivated. More information about the Debug Mode can be found in [“MODE Pin \(LIN SBC\) and Debug Mode” on page 8](#).

### 3.3.4 Boost Jumper – JP3

By default, this jumper is set so that the internal 5V voltage regulator is active with a current capability of 85mA (PVCC connected to VCC). Most LIN nodes have this current capability or less. For LIN nodes requiring more current, the current capability can be boosted by using some additional external components. Please refer to “[Boosting Up the Voltage Regulator](#)” on page 15 for a detailed description of how to boost the current of the internal voltage regulator.

### 3.3.5 EN Jumper – JP1

The default setting for the jumper connects the microcontroller enable output pin PA4 and the enable input pin EN from the LIN SBC. If pin PA4 is used for alternative functions in the application, the EN jumper can be removed so the PA4 pin can be accessed. In this case the enable input has to be controlled either by another I/O pin from the microcontroller or it can be set fixed to VCC. In both cases the connection to the enable input has to be made via an extra 1-wire cable.

## 3.4 Optional Components

The development board for the Atmel® ATA6616/ATA6617 provides some placeholders for mounting additional, optional components. Some factory-mounted components can be replaced so the LIN node can be adapted to meet the user's specific requirements. In the following sections these placeholders and components are shown and described.

### 3.4.1 Configuring the Atmel ATA6616-EK/ATA6617-EK as a Master or a Slave Node

Both the LIN 2.0 and LIN 2.1 specification require the master node in a LIN network be set up as shown in [Figure 3-3](#).

**Figure 3-3. External Circuitry for a LIN Master Node**

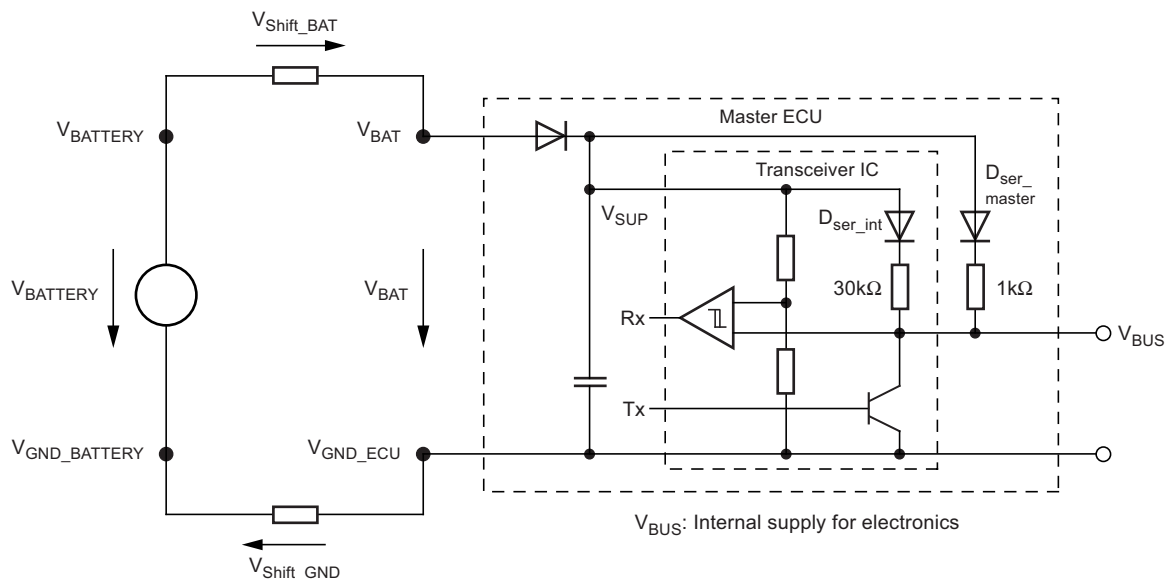

The difference between a master node and a slave node is the additional  $D_{ser\_master}$  diode and a serial 1kΩ pull-up resistor between  $V_{sup}$  and the LIN line. The placeholders for the two components D2 and R9 on the Atmel ATA6616-EK/ATA6617-EK are shown in [Figure 3-4](#) on page 12.



Figure 3-4. Diode and Resistor Necessary for LIN Master Applications

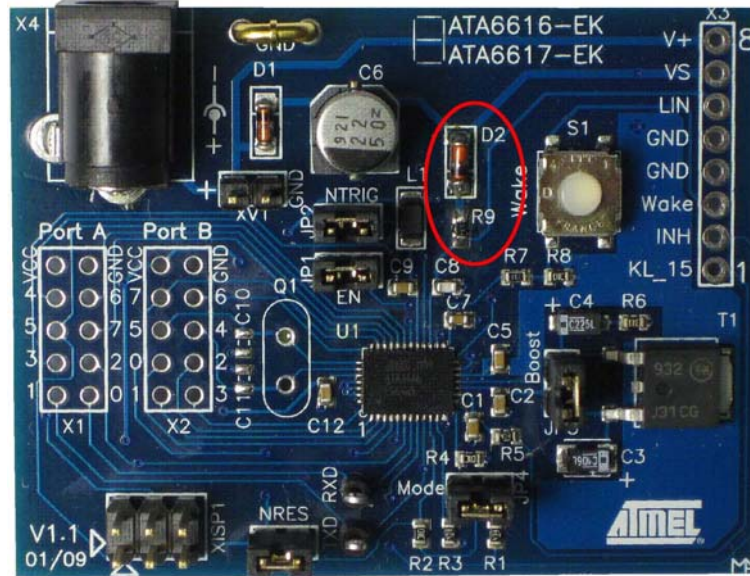

### 3.4.2 Running the Microcontroller on External Clock

For cases in which the accuracy of the internal RC oscillator is not sufficient to meet the application-specific requirements, an external crystal oscillator and the two capacitors can be mounted on the Atmel ATA6616/ATA8888. The location for these placeholders (Q1, C10, and C11) is shown in Figure 3-5. For the two load capacitor values check the datasheet of the relevant oscillator.

Figure 3-5. Placeholder for an External Crystal Oscillator and its Load Capacitors

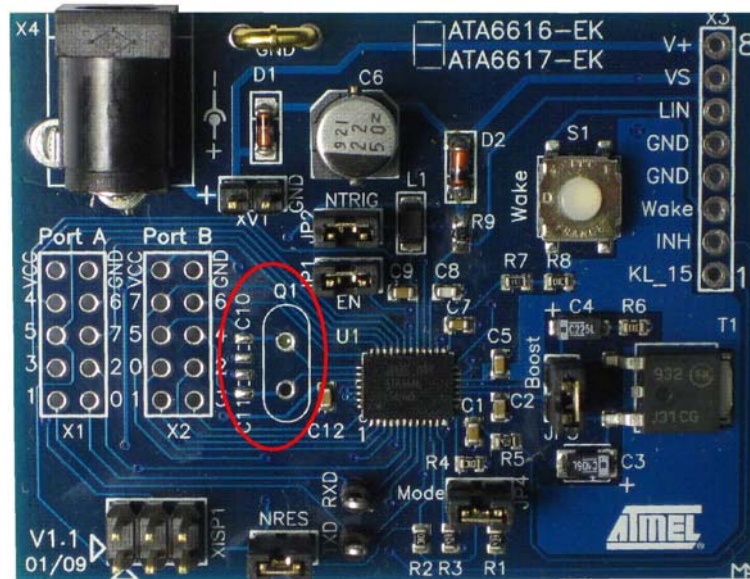

### 3.4.3 Changing the Watchdog Timings

The watchdog timing is generated with the help of a 51kΩ resistor (R3) connected between pin WD\_OSC and ground by default on the Atmel ATA6616/ATA6617 - EK. In order to change these timings, the R3 resistor has to be changed.

A description of how the resistor R3 influences the watchdog timing can be found in [“The Window Watchdog \(NTRIG, WD\\_OSC and NRES\)”](#) on page 6 and in the Atmel ATA6616/ATA6617 datasheet.

## 4. Programming and Debugging the Atmel ATA6616/ATA6617

The easiest way to program and debug the Atmel® ATA6616/ATA6617 is to use the AVR Studio® environment together with the Atmel STK®600 or the JTAG-ICE MkII. AVR Studio is an Integrated Development Environment (IDE) for writing and debugging AVR® applications Windows® 9x/Me/NT/2000/XP environments. AVR Studio provides a project management tool, source file editor, chip simulator, and in-circuit emulator interface for the powerful AVR 8-bit RISC family of microcontrollers.

### 4.1 Programming the Atmel ATA6616/ATA6617

Connect the selected hardware (STK600 or JTAG-ICE MkII) to the ISP header of the Atmel ATA6616-EK/ATA6617-EK via the 6-wire cable. Pin 1 is marked with two small triangles on the board.

In the AVR Studio, the two devices Atmel ATA6616 and Atmel ATA6617 are not listed in the supported devices list, because they contain the standard Atmel ATtiny87 and Atmel ATtiny167 devices respectively. To program the Atmel ATA6616, select the Atmel ATtiny87 and to program the Atmel ATA6617, select the Atmel ATtiny167.

For more information about using the STK600, the JTAG-ICE MkII or the AVR Studio, refer to the relevant documentation, available on the internet.

### 4.2 Debugging the ATA6616/ATA6617

Combined with AVR Studio, the JTAG-ICE MkII can perform on-chip debugging on all AVR 8-bit RISC microcontrollers with a JTAG or debugWIRE interface. The Atmel ATA6616 and Atmel ATA6617 come with a debugWIRE interface so only three wires are required for communication between the JTAG-ICE MkII and the board. These signals are RESET, VCC, and GND.

The debugWIRE on-chip debug system uses a one-wire bi-directional interface to control the program flow, execute AVR instructions in the CPU, and to program the various non-volatile memories. For debugging via debugWIRE, the reset line is used and the NRES jumper has to be removed because the JTAG ICE mkII requires exclusive access to this line.

For more detailed information about debugging via the debugWIRE interface, refer to the relevant documentation available on the Internet

## 5. Tools

As was briefly mentioned in the previous section, AVR Studio, in combination with the STK<sup>®</sup>600 and JTAG-ICE MkII, is a powerful tool for programming and debugging the AVR microcontroller family in general.

Furthermore, Atmel provides cost-effective software support for the development of a LIN network. These can easily be used together with the development board.

A LIN1.3 ANSI C software library for the AVR microcontroller family is available. The software library allows programming of protocol handling for LIN slave nodes. The library can be downloaded at [http://www.atmel.com/dyn/resources/prod\\_documents/doc1637.pdf](http://www.atmel.com/dyn/resources/prod_documents/doc1637.pdf)

Many OEMs require their suppliers to use certified third-party LIN protocol stacks. In order to satisfy this requirement, both, LIN 2.0 and LIN 2.1 protocol stacks are available for the Atmel<sup>®</sup> ATA6616 (Atmel ATtiny87) as well as for the Atmel ATA6617 (Atmel ATtiny167) from Mentor Graphics<sup>®</sup>, Vector Informatik, and from Warwick Control Technologies.

Warwick Control Technologies offers the NETGEN configuration and autocoder tool. For testing purposes and to provide a quick start to using Atmel products, there is a limited but free version available. The demo version is available at <http://www.warwickcontrol.com/>

For more information about the certified LIN stacks please contact the third party suppliers directly.

## 6. Boosting Up the Voltage Regulator

For some applications a higher current is required than what the internal voltage regulator is able to deliver (85mA). In order to meet this requirement, it is possible to boost the maximum current by using an external NPN transistor. A transistor, MJD31C in a D-PAK package, is already mounted on the development board, and, in addition to the transistor, there are two more components placed on the development board - the resistor R6 (3.3 $\Omega$ ) and the electrolytic capacitor C4 (2.2 $\mu$ F), which are needed for stability reasons. In addition, the jumper boost (JP3) has to be removed when using the external transistor.

Note that the output voltage is no longer short-circuit protected when boosting the output current with an external NPN transistor.

**Figure 6-1. External NPN Transistor and Additional Components Required for Boosting the Voltage Regulator Current**

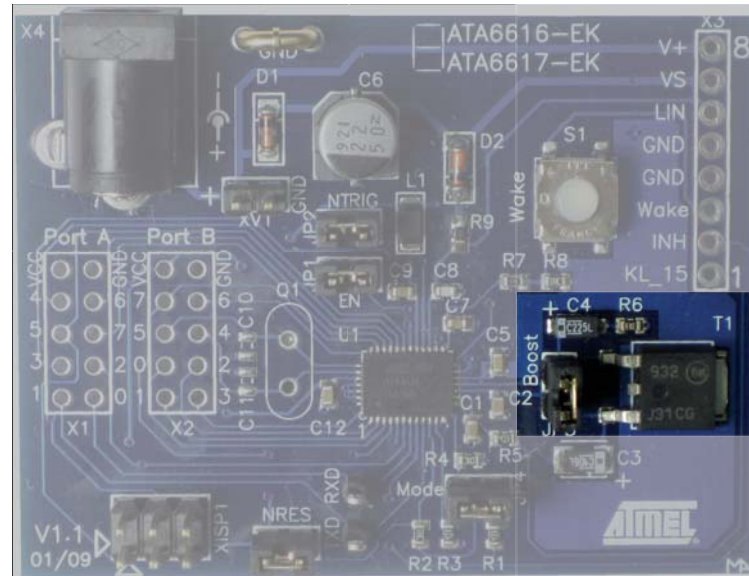

The limiting parameter for the currently available output current is the maximum power dissipation of the external NPN transistor. In the version at this stage, the thermal resistance of the MJD31C soldered on the minimum pad size is 80K/W. This means that the maximum possible output current when VS = 12V is approximately 230mA at room temperature. This limit should not be exceeded because the transistor could be damaged as a result of overtemperature. If a higher output current is required, additional cooling of the external transistor must be ensured.





## 8. Atmel ATA6616-EK/ATA6617-EK Board Layout

Figure 8-1. Atmel ATA6616-EK/ATA6617-EK Board Component Placement; Top side, Top View

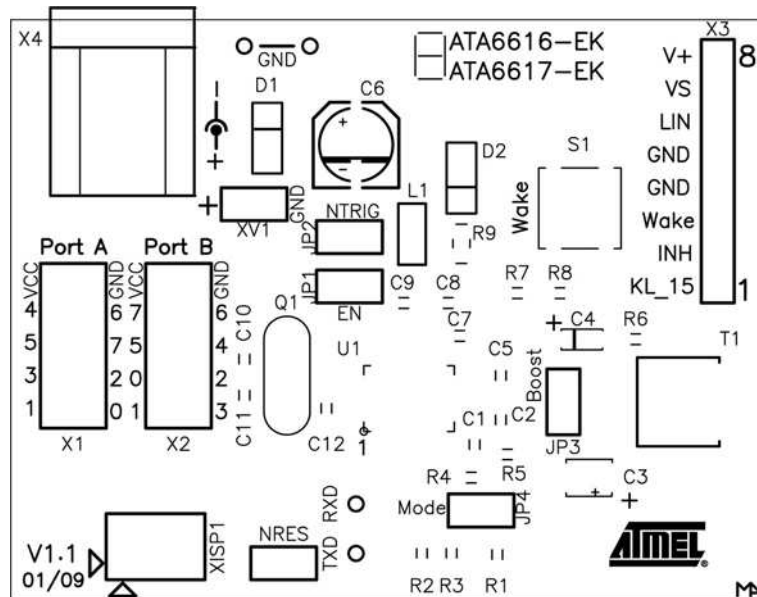

Figure 8-2. Atmel ATA6616-EK/ATA6617-EK Development Board; Top Side, Top View

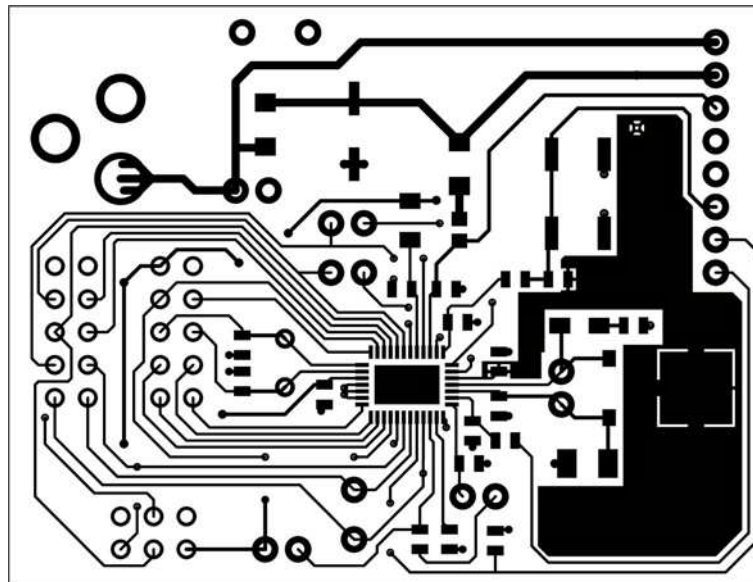
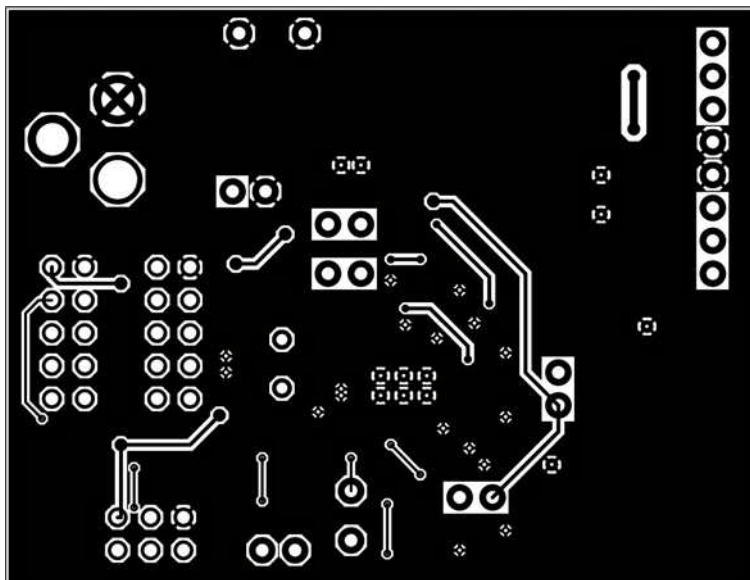

Figure 8-3. Atmel ATA6616-EK/ATA6617-EK Development Board; Bottom Side, Top View (as if PCB is Transparent)



## 9. Atmel ATA6616-EK/ATA6617-EK Bill of Material

Table 9-1. Atmel ATA6616/ATA6617 Bill of Material

Part No.	Designation	Value	Housing	Manufacturer/ Distributor
C1	Capacitor	100nF	SMD 0603 / X7R	e.g., Vishay
C2	Capacitor	100nF	SMD 0603 / X7R	e.g., Vishay
C3	Capacitor	10µF/16V Tantal	SMD Typ A-3216	e.g., Vishay
C4	Capacitor	2.2µF/16V Tantal	SMD Typ A-3216	e.g., Vishay
C5	Capacitor	100nF	SMD 0603 / X7R	e.g., Vishay
C6	Capacitor	22µF/50V Elco	SMD Typ D-7343	e.g., Panasonic
C7	Capacitor	10nF	SMD 0603 / X7R	e.g., Vishay
C8	Capacitor	220pF	SMD 0603 / X7R	e.g., Vishay
C9	Capacitor	100nF	SMD 0603 / X7R	e.g., Vishay
C10	Capacitor	Option (NC)		
C11	Capacitor	Option (NC)		
C12	Capacitor	100nF	SMD 0603 / X7R	e.g., Vishay
D1	Diode	LL4148	SOD-80C	e.g., Mira
D2	Diode	Option (NC)	SOD-80C	
L1	Filter Choke	10µH	SMD 1206	e.g., Mira OrderNr.: 7656/103
NTRIG, ENABLE, MODE, NRES, Boost, XV1	Header 2pole	1x2 pins	1001-171-002	e.g., CAB
ISP	Connector	2x3 pins	1002-171-006	e.g., CAB
Q1	Quartz	Option (NC)		
RXD, TXD	Test pin	1mm black	262-2179	e.g., RS
X1, X2	Connector	Option (NC)		
X3	Header 8pole	n.m.		
X4	Power jack	2.1mm	486-662	e.g. RS
T1	Transistor	MJD31C	348-4552	e.g. RS
S1	Switch	KSC 241 J	ITT Canon	e.g. Spörle
GND	Jumper link	pitch 5.08, d = 1mm	13.07.434	www.ettinger.de
U1	LIN SiP	ATA6616/ATA6617	SMD QFN38	Atmel
R1	Resistor	47k	SMD 0603	Standard
R2	Resistor	10k	SMD 0603	Standard
R3	Resistor	51k	SMD 0603	Standard
R4	Resistor	10k	SMD 0603	Standard
R5	Resistor	47k	SMD 0603	Standard
R6	Resistor	3R3	SMD 0603	Standard
R7	Resistor	33k	SMD 0603	Standard
R8	Resistor	10k	SMD 0603	Standard
R9	Resistor	n.m.	SMD 0603	Standard
	4x stick on feet	8x2.5mm black	223-859 3M	e.g., RS
	5x jumper	2.54mm	(3300111)	e.g., CAB
	PCB	ATA6616-EK/ ATA6617-EK V1.1	FRF, 1.5mm	





**Atmel Corporation** 1600 Technology Drive, San Jose, CA 95110 USA T: (+1)(408) 441.0311 F: (+1)(408) 436.4200 | [www.atmel.com](http://www.atmel.com)

© 2015 Atmel Corporation. / Rev.: 9342D-AUTO-09/13

Atmel®, Atmel logo and combinations thereof, Enabling Unlimited Possibilities®, AVR®, AVR Studio®, and others are registered trademarks or trademarks of Atmel Corporation in U.S. and other countries. Other terms and product names may be trademarks of others.

DISCLAIMER: The information in this document is provided in connection with Atmel products. No license, express or implied, by estoppel or otherwise, to any intellectual property right is granted by this document or in connection with the sale of Atmel products. EXCEPT AS SET FORTH IN THE ATMEL TERMS AND CONDITIONS OF SALES LOCATED ON THE ATMEL WEBSITE, ATMEL ASSUMES NO LIABILITY WHATSOEVER AND DISCLAIMS ANY EXPRESS, IMPLIED OR STATUTORY WARRANTY RELATING TO ITS PRODUCTS INCLUDING, BUT NOT LIMITED TO, THE IMPLIED WARRANTY OF MERCHANTABILITY, FITNESS FOR A PARTICULAR PURPOSE, OR NON-INFRINGEMENT. IN NO EVENT SHALL ATMEL BE LIABLE FOR ANY DIRECT, INDIRECT, CONSEQUENTIAL, PUNITIVE, SPECIAL OR INCIDENTAL DAMAGES (INCLUDING, WITHOUT LIMITATION, DAMAGES FOR LOSS AND PROFITS, BUSINESS INTERRUPTION, OR LOSS OF INFORMATION) ARISING OUT OF THE USE OR INABILITY TO USE THIS DOCUMENT, EVEN IF ATMEL HAS BEEN ADVISED OF THE POSSIBILITY OF SUCH DAMAGES. Atmel makes no representations or warranties with respect to the accuracy or completeness of the contents of this document and reserves the right to make changes to specifications and products descriptions at any time without notice. Atmel does not make any commitment to update the information contained herein. Unless specifically provided otherwise, Atmel products are not suitable for, and shall not be used in, automotive applications. Atmel products are not intended, authorized, or warranted for use as components in applications intended to support or sustain life.

SAFETY-CRITICAL, MILITARY, AND AUTOMOTIVE APPLICATIONS DISCLAIMER: Atmel products are not designed for and will not be used in connection with any applications where the failure of such products would reasonably be expected to result in significant personal injury or death ("Safety-Critical Applications") without an Atmel officer's specific written consent. Safety-Critical Applications include, without limitation, life support devices and systems, equipment or systems for the operation of nuclear facilities and weapons systems. Atmel products are not designed nor intended for use in military or aerospace applications or environments unless specifically designated by Atmel as military-grade. Atmel products are not designed nor intended for use in automotive applications unless specifically designated by Atmel as automotive-grade.