



Chipsmall Limited consists of a professional team with an average of over 10 year of expertise in the distribution of electronic components. Based in Hongkong, we have already established firm and mutual-benefit business relationships with customers from,Europe,America and south Asia,supplying obsolete and hard-to-find components to meet their specific needs.

With the principle of “Quality Parts,Customers Priority,Honest Operation,and Considerate Service”,our business mainly focus on the distribution of electronic components. Line cards we deal with include Microchip,ALPS,ROHM,Xilinx,Pulse,ON,Everlight and Freescale. Main products comprise IC,Modules,Potentiometer,IC Socket,Relay,Connector.Our parts cover such applications as commercial,industrial, and automotives areas.

We are looking forward to setting up business relationship with you and hope to provide you with the best service and solution. Let us make a better world for our industry!



Contact us

Tel: +86-755-8981 8866 Fax: +86-755-8427 6832

Email & Skype: info@chipsmall.com Web: www.chipsmall.com

Address: A1208, Overseas Decoration Building, #122 Zhenhua RD., Futian, Shenzhen, China





Balun transformers

Wound SMD

ATB series

ATB2012E-20011 (2.0×1.2×0.6mm)

ATB2012-50011 (2.0×1.2×1.2mm)

ATB2012E-50011M (2.0×1.2×1.0mm)

ATB2012E-50012M (2.0×1.2×1.0mm)

ATB2012-75011 (2.0×1.2×1.2mm)

ATB2012E-75011M (2.0×1.2×1.0mm)

REMINDERS FOR USING THESE PRODUCTS

Before using these products, be sure to request the delivery specifications.

SAFETY REMINDERS

Please pay sufficient attention to the warnings for safe designing when using this products.

REMINDERS

- The storage period is less than 6 months. Be sure to follow the storage conditions (temperature: 5 to 40°C, humidity: 10 to 75% RH or less).
If the storage period elapses, the soldering of the terminal electrodes may deteriorate.
- Do not use or store in locations where there are conditions such as gas corrosion (salt, acid, alkali, etc.).
- Before soldering, be sure to preheat components.
The preheating temperature should be set so that the temperature difference between the solder temperature and chip temperature does not exceed 150°C.
- Soldering corrections after mounting should be within the range of the conditions determined in the specifications.
If overheated, a short circuit, performance deterioration, or lifespan shortening may occur.
- When embedding a printed circuit board where a chip is mounted to a set, be sure that residual stress is not given to the chip due to the overall distortion of the printed circuit board and partial distortion such as at screw tightening portions.
- Self heating (temperature increase) occurs when the power is turned ON, so the tolerance should be sufficient for the set thermal design.
- Carefully lay out the coil for the circuit board design of the non-magnetic shield type.
A malfunction may occur due to magnetic interference.
- Use a wrist band to discharge static electricity in your body through the grounding wire.
- Do not expose the products to magnets or magnetic fields.
- Do not use for a purpose outside of the contents regulated in the delivery specifications.
- The products listed on this catalog are intended for use in general electronic equipment (AV equipment, telecommunications equipment, home appliances, amusement equipment, computer equipment, personal equipment, office equipment, measurement equipment, industrial robots) under a normal operation and use condition.
The products are not designed or warranted to meet the requirements of the applications listed below, whose performance and/or quality require a more stringent level of safety or reliability, or whose failure, malfunction or trouble could cause serious damage to society, person or property.
If you intend to use the products in the applications listed below or if you have special requirements exceeding the range or conditions set forth in the each catalog, please contact us.

- (1) Aerospace/aviation equipment
- (2) Transportation equipment (cars, electric trains, ships, etc.)
- (3) Medical equipment
- (4) Power-generation control equipment
- (5) Atomic energy-related equipment
- (6) Seabed equipment
- (7) Transportation control equipment

- (8) Public information-processing equipment
- (9) Military equipment
- (10) Electric heating apparatus, burning equipment
- (11) Disaster prevention/crime prevention equipment
- (12) Safety equipment
- (13) Other applications that are not considered general-purpose applications

When designing your equipment even for general-purpose applications, you are kindly requested to take into consideration securing protection circuit/device or providing backup circuits in your equipment.

Balun transformers

Wound SMD

Product compatible with RoHS directive

Halogen-free

Compatible with lead-free solders

Overview of the ATB series

FEATURES

- The ATB2012 case size is L2.0×W1.2.
- The case size is smaller than conventional Baluns.
- Low insertion loss and good balance parameters.
- Conforms to the RoHS Directive.

APPLICATION

- TV and mobile device tuners (DVB-T/H, ISDB-T, etc.)
- STB / tuner power divider
- NFC (Near Field Communication)

PART NUMBER CONSTRUCTION

ATB	2012	E	-	200	11	-	T	06	
Series name	L x W dimensions (mm)		Internal code	Input impedance (Ω)		Impedance ratio		Packaging style	Internal code
	2012	2.0x1.2	E	200	20	11	1:1	T	ø180mm reel

ATB	2012	-	500	11	-	T	000	
Series name	L x W dimensions (mm)		Input impedance (Ω)		Impedance ratio		Packaging style	Internal code
	2012	2.0x1.2	500	50	11	1:1	T	ø180mm reel
			750	75				

ATB	2012	E	-	500	11	M	-	T	01
Series name	L x W dimensions (mm)		Internal code	Input impedance (Ω)		Product internal	Packaging style	Internal code	
	2012	2.0x1.2	E	500	50	M	T	ø180mm reel	
				750	75				
						12		1:2	

OPERATING TEMPERATURE RANGE, PACKAGE QUANTITY, PRODUCT WEIGHT

Type	Temperature range		Reel diameter	Package quantity (pieces/reel)	Individual weight (mg)
	Operating temperature* (°C)	Storage temperature** (°C)			
ATB2012E-20011	-40 to +85	-40 to +85	ø180mm	4000	5
ATB2012E-50011	-40 to +85	-40 to +85	ø180mm	2000	8
ATB2012E-50011M	-40 to +85	-40 to +85	ø180mm	2000	8
ATB2012E-50012M	-40 to +85	-40 to +85	ø180mm	2000	8
ATB2012E-75011	-40 to +85	-40 to +85	ø180mm	2000	8
ATB2012E-75011M	-40 to +85	-40 to +85	ø180mm	2000	8

* Operating temperature range includes self-temperature rise.

** The storage temperature range is for after the assembly.

○ RoHS Directive Compliant Product: See the following for more details. <https://product.tdk.com/info/en/environment/rohs/index.html>

○ Halogen-free: indicates that Cl content is less than 900ppm, Br content is less than 900ppm, and that the total Cl and Br content is less than 1500ppm.

⚠ Please be sure to request delivery specifications that provide further details on the features and specifications of the products for proper and safe use. Please note that the contents may change without any prior notice due to reasons such as upgrading.

Overview of the ATB series

RECOMMENDED REFLOW PROFILE

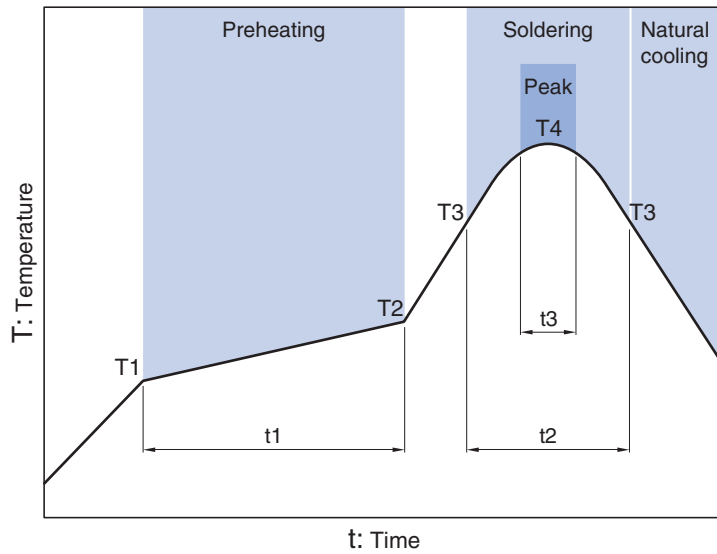

Preheating			Soldering		Peak	
Temp.	Temp.	Time	Temp.	Time	Temp.	Time
T1	T2	t1	T3	t2	T4	t3
150°C	180°C	60 to 120s	230°C	10 to 30s	245°C	5s max.

ATB series

ATB2012E-20011 type

SHAPE & DIMENSIONS

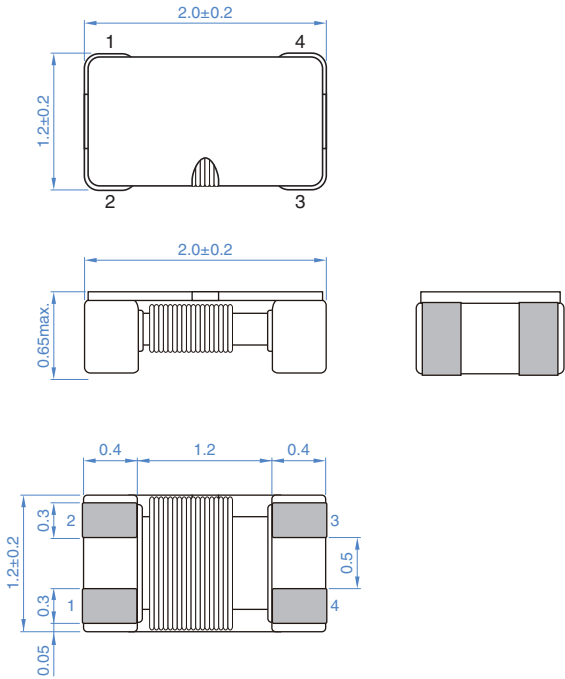

Dimensions in mm

RECOMMENDED LAND PATTERN

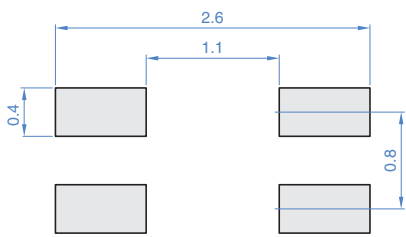

Dimensions in mm

CIRCUIT DIAGRAM

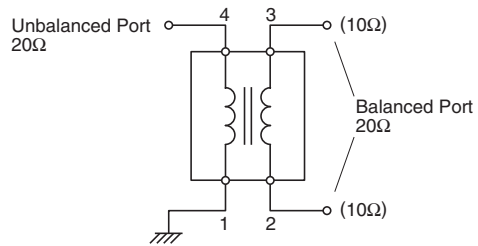

⚠ Please be sure to request delivery specifications that provide further details on the features and specifications of the products for proper and safe use. Please note that the contents may change without any prior notice due to reasons such as upgrading.

ATB series ATB2012E-20011 type

ELECTRICAL CHARACTERISTICS

CHARACTERISTICS SPECIFICATION TABLE

Frequency range (MHz)	UB/B impedance (Ω)	Insertion loss (dB)max.	CMRR typ.	DC resistance (Ω)max.	Rated current (mA)	Rated voltage (V)	Insulation resistance ($M\Omega$)min.	Part No.
13.56	20/20	1.0	20	1.5	150	20	10	ATB2012E-20011-T06

FREQUENCY CHARACTERISTICS

INSERTION LOSS

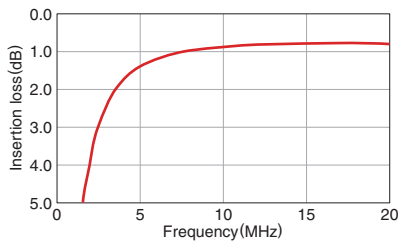

RETURN LOSS

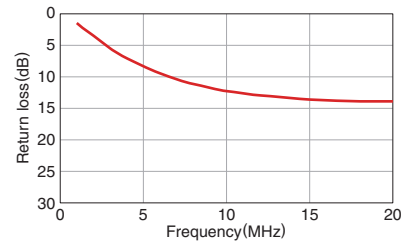

CMRR

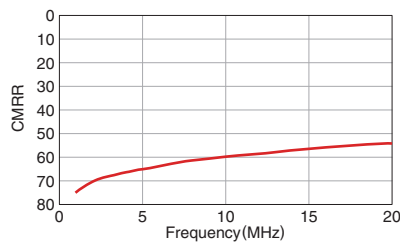

PHASE BALANCE

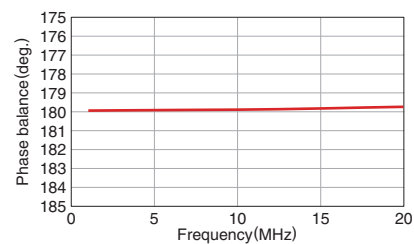

Measurement equipment

Measurement item	Product No.	Manufacturer
DC resistance	4338A	Keysight Technologies
Insulation resistance	4339A	Keysight Technologies
Insertion loss	E5071B	Keysight Technologies
Return loss	E5071B	Keysight Technologies
Amplitude imbalance	E5071B	Keysight Technologies
Phase balance	E5071B	Keysight Technologies

* Equivalent measurement equipment may be used.

ATB series

ATB2012-50011 type

SHAPE & DIMENSIONS

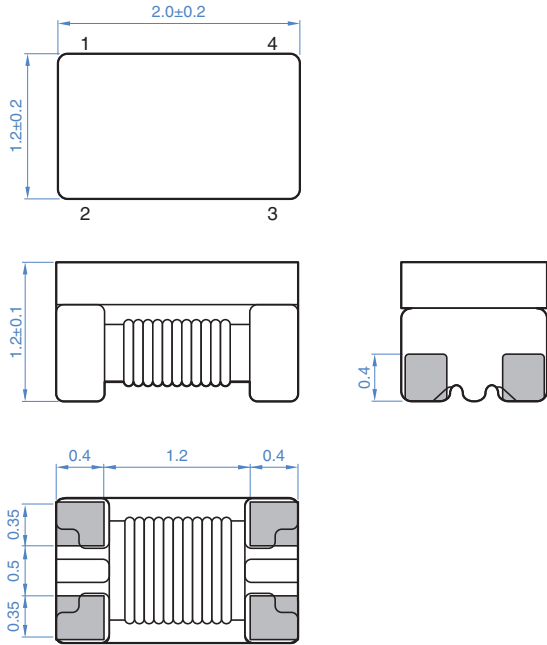

Dimensions in mm

RECOMMENDED LAND PATTERN

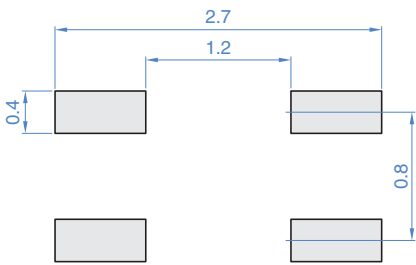

Dimensions in mm

CIRCUIT DIAGRAM

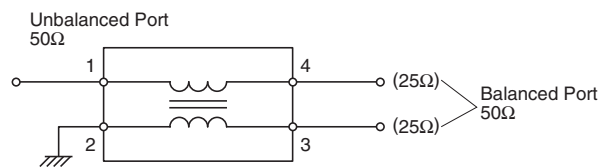

 Please be sure to request delivery specifications that provide further details on the features and specifications of the products for proper and safe use. Please note that the contents may change without any prior notice due to reasons such as upgrading.

ATB series ATB2012-50011 type

ELECTRICAL CHARACTERISTICS

CHARACTERISTICS SPECIFICATION TABLE

Frequency range (MHz)	UB/B impedance (Ω)	Insertion loss (dB)		CMRR typ.	DC resistance (Ω)max.	Rated current (mA)	Rated voltage (V)	Insulation resistance ($M\Omega$)min.	Withstanding voltage (V)	Part No.
		typ.	max.							
40 to 860	50/50	1.0	2.5	20	1.0	200	20	10	125	ATB2012-50011-T000

FREQUENCY CHARACTERISTICS

INSERTION LOSS

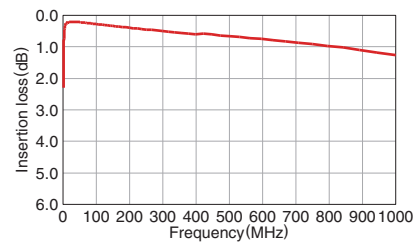

RETURN LOSS

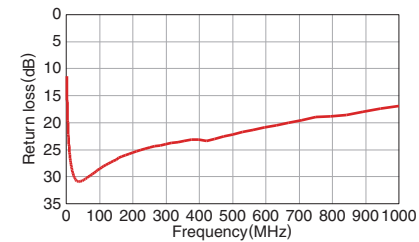

AMPLITUDE IMBALANCE

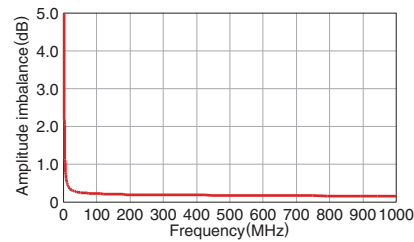

PHASE BALANCE

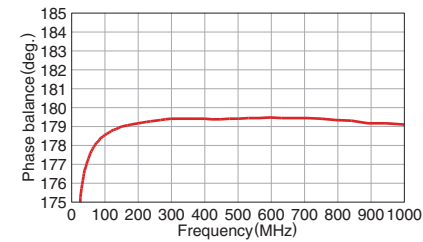

Measurement equipment

Measurement item	Product No.	Manufacturer
DC resistance	4338A	Keysight Technologies
Insulation resistance	4339A	Keysight Technologies
Insertion loss	E5071B	Keysight Technologies
Return loss	E5071B	Keysight Technologies
Amplitude imbalance	E5071B	Keysight Technologies
Phase balance	E5071B	Keysight Technologies

* Equivalent measurement equipment may be used.

ATB series

ATB2012E-50011M type ATB2012E-50012M type

SHAPE & DIMENSIONS

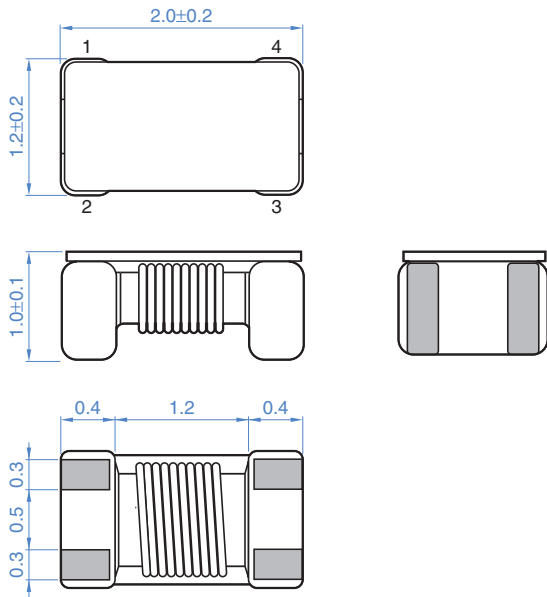

Dimensions in mm

RECOMMENDED LAND PATTERN

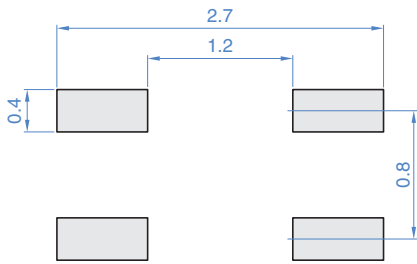

Dimensions in mm

CIRCUIT DIAGRAM

ATB2012E-50011M type

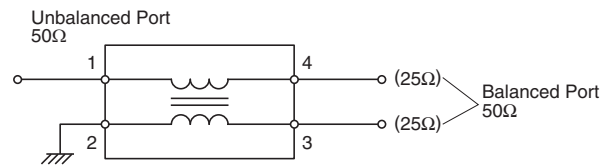

ATB2012E-50012M type

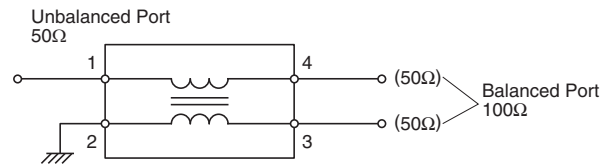

 Please be sure to request delivery specifications that provide further details on the features and specifications of the products for proper and safe use. Please note that the contents may change without any prior notice due to reasons such as upgrading.

ATB series **ATB2012E-50011M type** **ATB2012E-50012M type**

■ ELECTRICAL CHARACTERISTICS

□ CHARACTERISTICS SPECIFICATION TABLE

Frequency range (MHz)	UB/B impedance (Ω)	Insertion loss (dB)		CMRR typ.	DC resistance (Ω)max.	Rated current (mA)	Rated voltage (V)	Insulation resistance ($M\Omega$)min.	Withstanding voltage (V)	Part No.
		typ.	max.							
400 to 1800	50/50	1.0	2.2	15	0.5	150	20	10	125	ATB2012E-50011M-T01
400 to 1800	50/100	1.0	2.5	15	0.5	150	20	10	125	ATB2012E-50012M-T01

ATB series **ATB2012E-50011M type** **ATB2012E-50012M type**

■ FREQUENCY CHARACTERISTICS

ATB2012E-50011M type

□ INSERTION LOSS

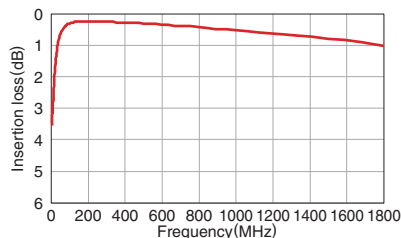

□ RETURN LOSS

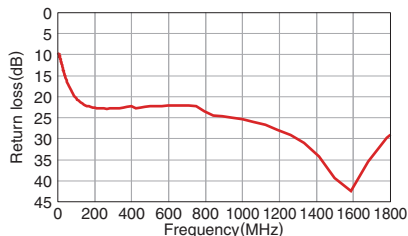

□ AMPLITUDE IMBALANCE

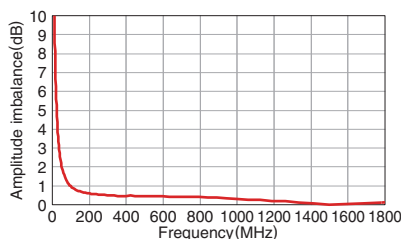

□ PHASE BALANCE

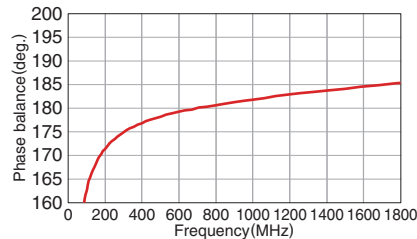

ATB2012E-50012M type

□ INSERTION LOSS

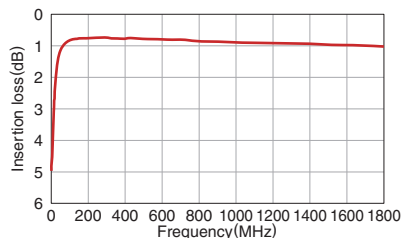

□ RETURN LOSS

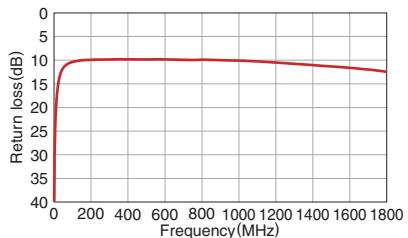

□ AMPLITUDE IMBALANCE

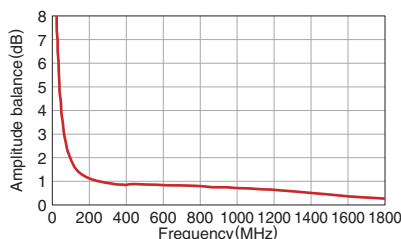

□ PHASE BALANCE

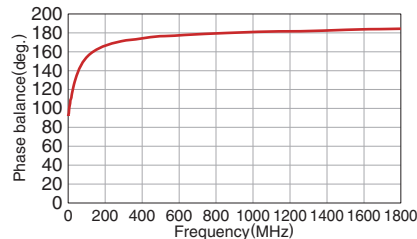

○ Measurement equipment

Measurement item	Product No.	Manufacturer
DC resistance	4338A	Keysight Technologies
Insulation resistance	4339A	Keysight Technologies
Insertion loss	E5071B	Keysight Technologies
Return loss	E5071B	Keysight Technologies
Amplitude imbalance	E5071B	Keysight Technologies
Phase balance	E5071B	Keysight Technologies

* Equivalent measurement equipment may be used.

⚠ Please be sure to request delivery specifications that provide further details on the features and specifications of the products for proper and safe use. Please note that the contents may change without any prior notice due to reasons such as upgrading.

ATB series

ATB2012-75011 type

SHAPE & DIMENSIONS

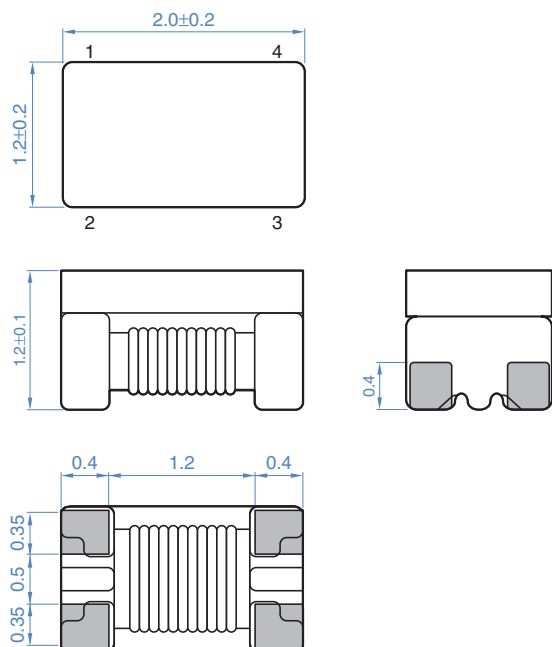

Dimensions in mm

RECOMMENDED LAND PATTERN

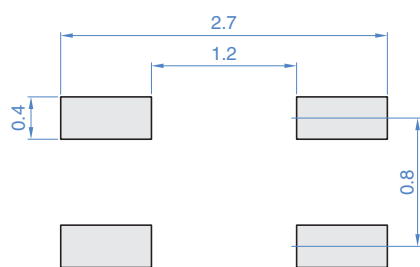

Dimensions in mm

CIRCUIT DIAGRAM

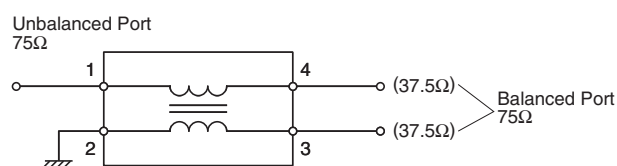

ATB series ATB2012-75011 type

ELECTRICAL CHARACTERISTICS

CHARACTERISTICS SPECIFICATION TABLE

Frequency range (MHz)	UB/B impedance (Ω)	Insertion loss (dB)		CMRR typ.	DC resistance (Ω)max.	Rated current (mA)	Rated voltage (V)	Insulation resistance ($M\Omega$)min.	Withstanding voltage (V)	Part No.
		typ.	max.							
50 to 1200	75/75	0.8	1.2	20	0.7	280	20	10	125	ATB2012-75011-T000

FREQUENCY CHARACTERISTICS

INSERTION LOSS

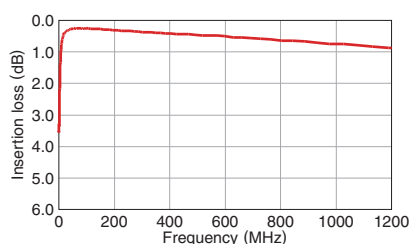

RETURN LOSS

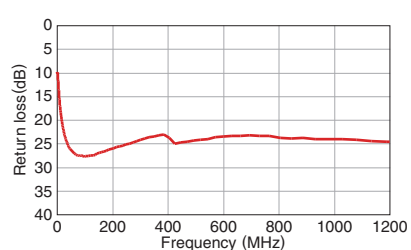

AMPLITUDE IMBALANCE

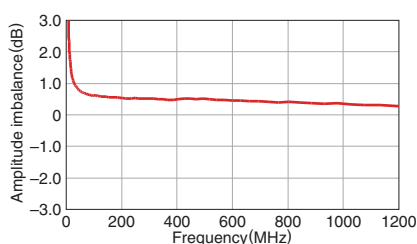

PHASE BALANCE

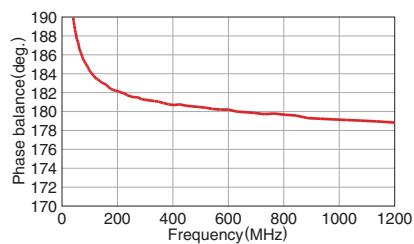

Measurement equipment

Measurement item	Product No.	Manufacturer
DC resistance	4338A	Keysight Technologies
Insulation resistance	4339A	Keysight Technologies
Insertion loss	E5071B	Keysight Technologies
Return loss	E5071B	Keysight Technologies
Amplitude imbalance	E5071B	Keysight Technologies
Phase balance	E5071B	Keysight Technologies

* Equivalent measurement equipment may be used.

ATB series

ATB2012E-75011M type

SHAPE & DIMENSIONS

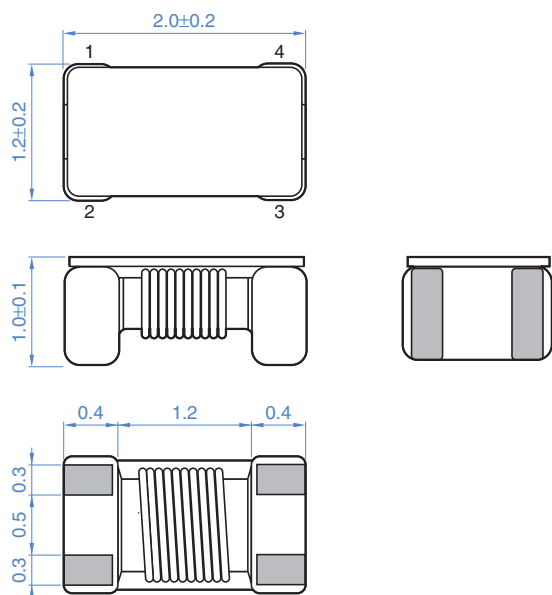

Dimensions in mm

RECOMMENDED LAND PATTERN

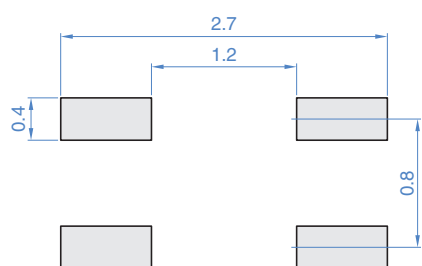

Dimensions in mm

CIRCUIT DIAGRAM

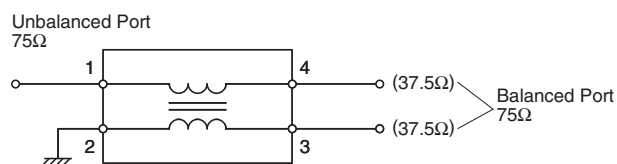

ATB series ATB2012E-75011M type

ELECTRICAL CHARACTERISTICS

CHARACTERISTICS SPECIFICATION TABLE

Frequency range (MHz)	UB/B impedance (Ω)	Insertion loss (dB)		CMRR typ.	DC resistance (Ω)max.	Rated current (mA)	Rated voltage (V)	Insulation resistance ($M\Omega$)min.	Withstanding voltage (V)	Part No.
		typ.	max.							
400 to 1800	75/75	1.0	2	15	0.5	150	20	10	125	ATB2012E-75011M-T01

FREQUENCY CHARACTERISTICS

INSERTION LOSS

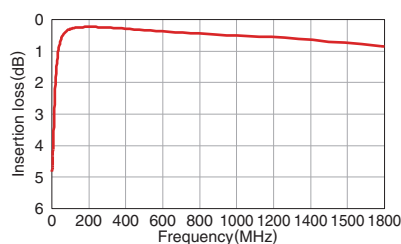

RETURN LOSS

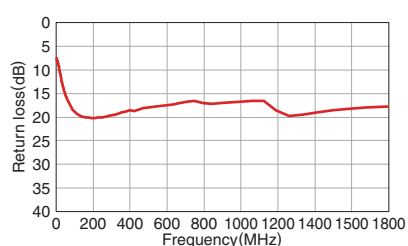

AMPLITUDE IMBALANCE

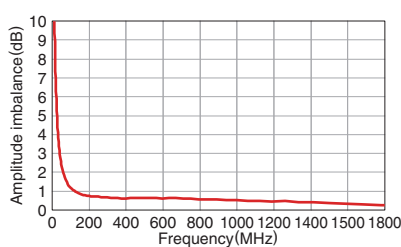

PHASE BALANCE

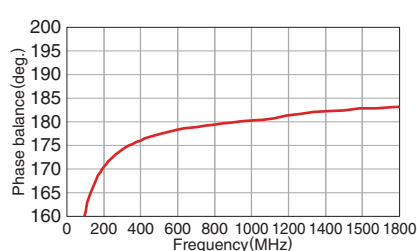

Measurement equipment

Measurement item	Product No.	Manufacturer
DC resistance	4338A	Keysight Technologies
Insulation resistance	4339A	Keysight Technologies
Insertion loss	E5071B	Keysight Technologies
Return loss	E5071B	Keysight Technologies
Amplitude imbalance	E5071B	Keysight Technologies
Phase balance	E5071B	Keysight Technologies

* Equivalent measurement equipment may be used.

ATB series

Packaging style

REEL DIMENSIONS

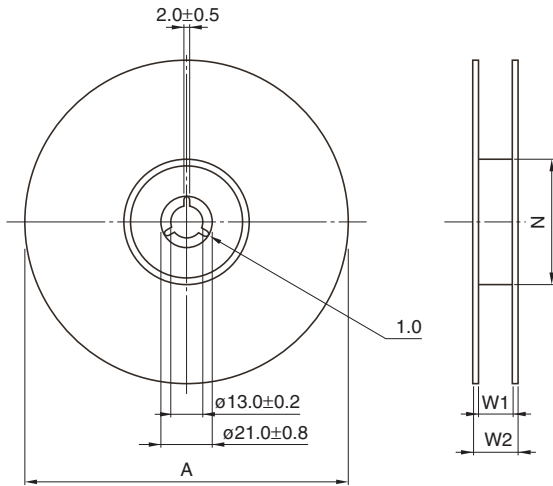

Dimensions in mm

Type	A	W1	W2	N
ATB2012E-20011	φ180	13	60	9
ATB2012-50011	φ180	13	60	9
ATB2012E-50011M	φ180	13	60	9
ATB2012E-50012M				
ATB2012-75011	φ180	13	60	9
ATB2012E-75011M	φ180	13	60	9

TAPE DIMENSIONS

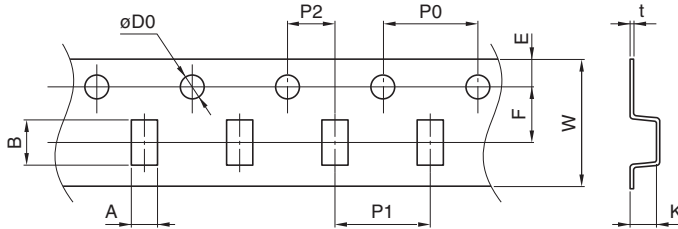

Dimensions in mm

Type	A	B	0D0	E	F	P0	P1	P2	W	K	t
ATB2012E-20011	1.45±0.1	2.25±0.1	1.55±0.05	1.75±0.1	3.50±0.05	4.0±0.1	4.0±0.1	2.0±0.05	8.0±0.20	0.75±0.05	0.25±0.05
ATB2012-50011	1.4±0.1	2.3±0.1	1.5+0.1/0	1.75±0.1	3.5±0.1	4.0±0.1	4.0±0.1	2.0±0.1	8.0±0.1	1.4±0.1	0.25±0.05
ATB2012E-50011M	1.4±0.1	2.3±0.1	1.5+0.1/0	1.75±0.1	3.5±0.1	4.0±0.1	4.0±0.1	2.0±0.1	8.0±0.1	1.15±0.1	0.2±0.05
ATB2012E-50012M											
ATB2012-75011	1.4±0.1	2.3±0.1	1.5+0.1/0	1.75±0.1	3.5±0.1	4.0±0.1	4.0±0.1	2.0±0.1	8.0±0.1	1.4±0.1	0.25±0.05
ATB2012E-75011M	1.4±0.1	2.3±0.1	1.5+0.1/0	1.75±0.1	3.5±0.1	4.0±0.1	4.0±0.1	2.0±0.1	8.0±0.1	1.15±0.1	0.2±0.05

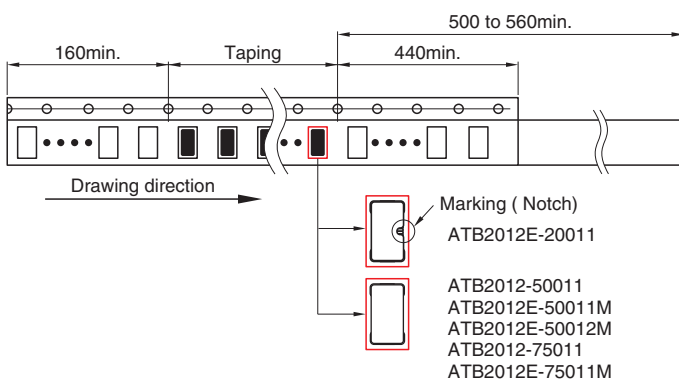

Dimensions in mm

⚠ Please be sure to request delivery specifications that provide further details on the features and specifications of the products for proper and safe use.
Please note that the contents may change without any prior notice due to reasons such as upgrading.