



Chipsmall Limited consists of a professional team with an average of over 10 year of expertise in the distribution of electronic components. Based in Hongkong, we have already established firm and mutual-benefit business relationships with customers from,Europe,America and south Asia,supplying obsolete and hard-to-find components to meet their specific needs.

With the principle of “Quality Parts,Customers Priority,Honest Operation,and Considerate Service”,our business mainly focus on the distribution of electronic components. Line cards we deal with include Microchip,ALPS,ROHM,Xilinx,Pulse,ON,Everlight and Freescale. Main products comprise IC,Modules,Potentiometer,IC Socket,Relay,Connector.Our parts cover such applications as commercial,industrial, and automotives areas.

We are looking forward to setting up business relationship with you and hope to provide you with the best service and solution. Let us make a better world for our industry!



## Contact us

Tel: +86-755-8981 8866 Fax: +86-755-8427 6832

Email & Skype: info@chipsmall.com Web: www.chipsmall.com

Address: A1208, Overseas Decoration Building, #122 Zhenhua RD., Futian, Shenzhen, China



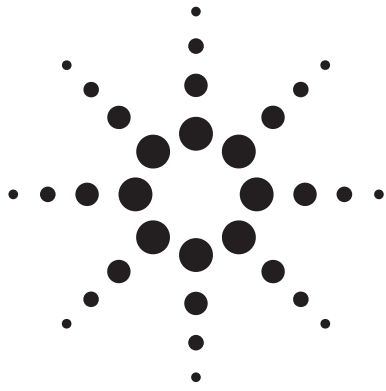

# Agilent ATF-54143 Low Noise Enhancement Mode Pseudomorphic HEMT in a Surface Mount Plastic Package

## Data Sheet

### Description

Agilent Technologies's ATF-54143 is a high dynamic range, low noise, E-PHEMT housed in a 4-lead SC-70 (SOT-343) surface mount plastic package.

The combination of high gain, high linearity and low noise makes the ATF-54143 ideal for cellular/PCS base stations, MMDS, and other systems in the 450 MHz to 6 GHz frequency range.

### Surface Mount Package SOT-343

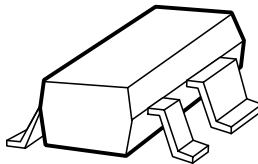

### Pin Connections and Package Marking

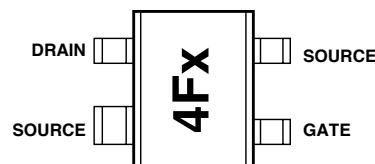

**Note:**  
Top View. Package marking provides orientation and identification

"4F" = Device Code  
"x" = Date code character identifies month of manufacture.

### Features

- High linearity performance
- Enhancement Mode Technology<sup>[1]</sup>
- Low noise figure
- Excellent uniformity in product specifications
- 800 micron gate width
- Low cost surface mount small plastic package SOT-343 (4 lead SC-70)
- Tape-and-Reel packaging option available
- Lead-free option available.

### Specifications

- 2 GHz; 3V, 60 mA (Typ.)
- 36.2 dBm output 3<sup>rd</sup> order intercept
  - 20.4 dBm output power at 1 dB gain compression
  - 0.5 dB noise figure
  - 16.6 dB associated gain

### Applications

- Low noise amplifier for cellular/PCS base stations
- LNA for WLAN, WLL/RLL and MMDS applications
- General purpose discrete E-PHEMT for other ultra low noise applications

### Note:

1. Enhancement mode technology requires positive Vgs, thereby eliminating the need for the negative gate voltage associated with conventional depletion mode devices.



**Attention:**  
Observe precautions for handling electrostatic sensitive devices.

ESD Machine Model (Class A)

ESD Human Body Model (Class 1A)

Refer to Agilent Application Note A004R: Electrostatic Discharge Damage and Control.



Agilent Technologies

## ATF-54143 Absolute Maximum Ratings<sup>[1]</sup>

Symbol	Parameter	Units	Absolute Maximum
$V_{DS}$	Drain - Source Voltage <sup>[2]</sup>	V	5
$V_{GS}$	Gate - Source Voltage <sup>[2]</sup>	V	-5 to 1
$V_{GD}$	Gate Drain Voltage <sup>[2]</sup>	V	-5 to 1
$I_{DS}$	Drain Current <sup>[2]</sup>	mA	120
$P_{diss}$	Total Power Dissipation <sup>[3]</sup>	mW	725
$P_{in\ max}$	RF Input Power	dBm	13 <sup>[5]</sup>
$I_{GS}$	Gate Source Current	mA	2 <sup>[5]</sup>
$T_{CH}$	Channel Temperature	°C	150
$T_{STG}$	Storage Temperature	°C	-65 to 150
$\theta_{jc}$	Thermal Resistance <sup>[4]</sup>	°C/W	162

### Notes:

1. Operation of this device in excess of any one of these parameters may cause permanent damage.
2. Assumes DC quiescent conditions.
3. Source lead temperature is 25°C. Derate 6.2 mW/°C for  $T_L > 33^\circ\text{C}$ .
4. Thermal resistance measured using 150°C Liquid Crystal Measurement method.
5. The device can handle +13 dBm RF Input Power provided  $I_{GS}$  is limited to 2 mA.  $I_{GS}$  at  $P_{1dB}$  drive level is bias circuit dependent. See application section for additional information.

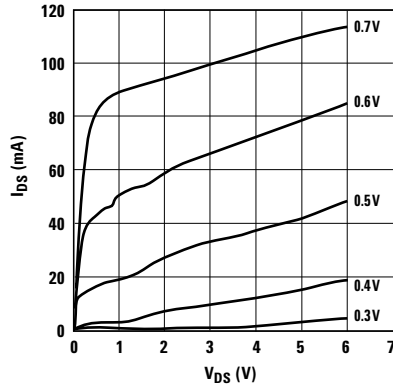

Figure 1. Typical I-V Curves.  
( $V_{GS} = 0.1\text{ V}$  per step)

## Product Consistency Distribution Charts<sup>[6, 7]</sup>

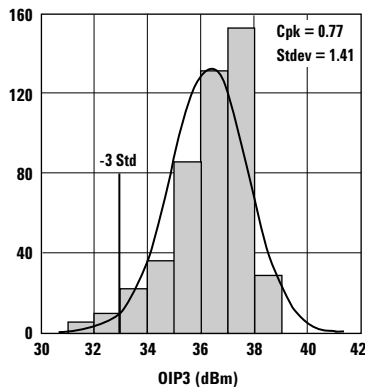

Figure 2. OIP3 @ 2 GHz, 3 V, 60 mA.  
LSL = 33.0, Nominal = 36.575

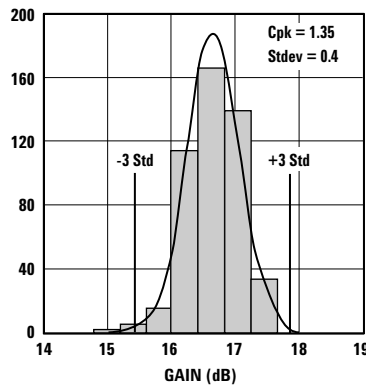

Figure 3. Gain @ 2 GHz, 3 V, 60 mA.  
USL = 18.5, LSL = 15, Nominal = 16.6

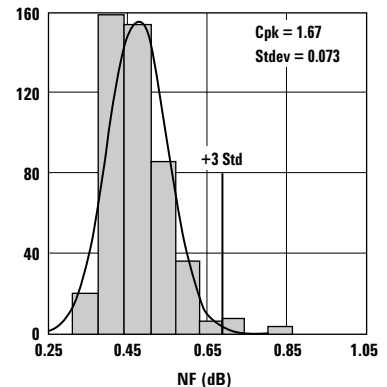

Figure 4. NF @ 2 GHz, 3 V, 60 mA.  
USL = 0.9, Nominal = 0.49

### Notes:

6. Distribution data sample size is 450 samples taken from 9 different wafers. Future wafers allocated to this product may have nominal values anywhere between the upper and lower limits.
7. Measurements made on production test board. This circuit represents a trade-off between an optimal noise match and a realizable match based on production test equipment. Circuit losses have been de-embedded from actual measurements.

## ATF-54143 Electrical Specifications

$T_A = 25^\circ\text{C}$ , RF parameters measured in a test circuit for a typical device

Symbol	Parameter and Test Condition		Units	Min.	Typ. <sup>[2]</sup>	Max.	
Vgs	Operational Gate Voltage		Vds = 3V, Ids = 60 mA	V	0.4	0.59	0.75
Vth	Threshold Voltage		Vds = 3V, Ids = 4 mA	V	0.18	0.38	0.52
Idss	Saturated Drain Current		Vds = 3V, Vgs = 0V	$\mu\text{A}$	—	1	5
Gm	Transconductance		Vds = 3V, gm = $\Delta\text{Idss}/\Delta\text{Vgs}$ ; $\Delta\text{Vgs} = 0.75 - 0.7 = 0.05\text{V}$	mmho	230	410	560
Igss	Gate Leakage Current		Vgd = Vgs = -3V	$\mu\text{A}$	—	—	200
NF	Noise Figure <sup>[1]</sup>	f = 2 GHz	Vds = 3V, Ids = 60 mA	dB	—	0.5	0.9
		f = 900 MHz	Vds = 3V, Ids = 60 mA	dB	—	0.3	—
Ga	Associated Gain <sup>[1]</sup>	f = 2 GHz	Vds = 3V, Ids = 60 mA	dB	15	16.6	18.5
		f = 900 MHz	Vds = 3V, Ids = 60 mA	dB	—	23.4	—
OIP3	Output 3 <sup>rd</sup> Order Intercept Point <sup>[1]</sup>	f = 2 GHz	Vds = 3V, Ids = 60 mA	dBm	33	36.2	—
		f = 900 MHz	Vds = 3V, Ids = 60 mA	dBm	—	35.5	—
P1dB	1dB Compressed Output Power <sup>[1]</sup>	f = 2 GHz	Vds = 3V, Ids = 60 mA	dBm	—	20.4	—
		f = 900 MHz	Vds = 3V, Ids = 60 mA	dBm	—	18.4	—

### Notes:

1. Measurements obtained using production test board described in Figure 5.
2. Typical values measured from a sample size of 450 parts from 9 wafers.

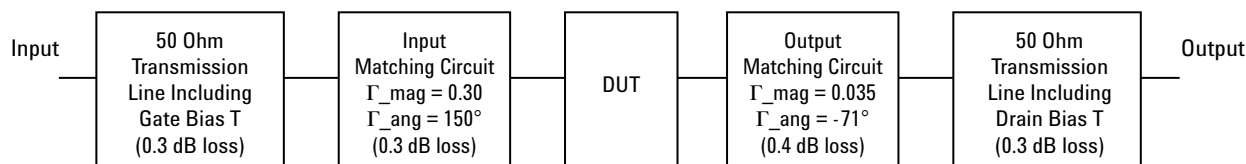

**Figure 5. Block diagram of 2 GHz production test board used for Noise Figure, Associated Gain, P1dB, and OIP3 measurements. This circuit represents a trade-off between an optimal noise match and associated impedance matching circuit losses. Circuit losses have been de-embedded from actual measurements.**

## ATF-54143 Typical Performance Curves

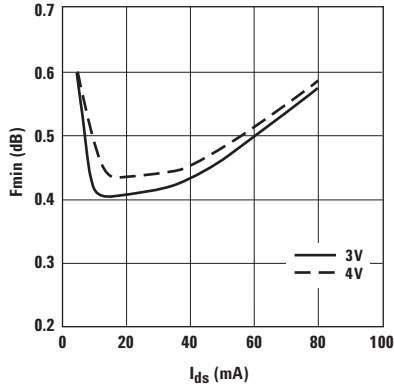

Figure 6. Fmin vs.  $I_{ds}$  and  $V_{ds}$  Tuned for Max OIP3 and Fmin at 2 GHz.

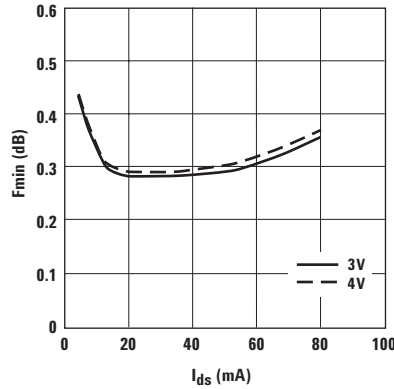

Figure 7. Fmin vs.  $I_{ds}$  and  $V_{ds}$  Tuned for Max OIP3 and Min NF at 900 MHz.

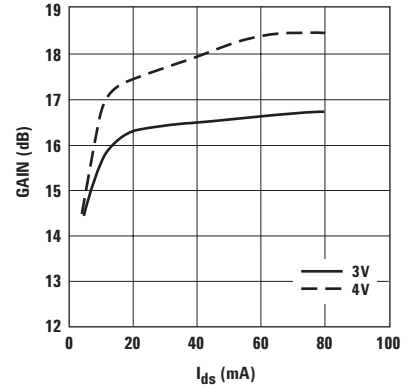

Figure 8. Gain vs.  $I_{ds}$  and  $V_{ds}$  Tuned for Max OIP3 and Fmin at 2 GHz.

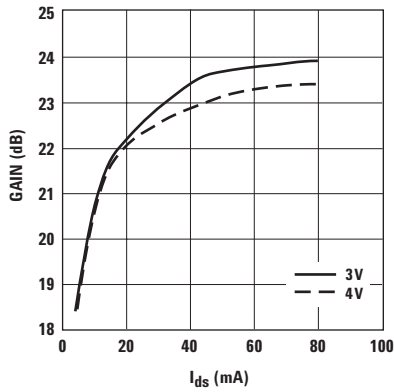

Figure 9. Gain vs.  $I_{ds}$  and  $V_{ds}$  Tuned for Max OIP3 and Fmin at 900 MHz.

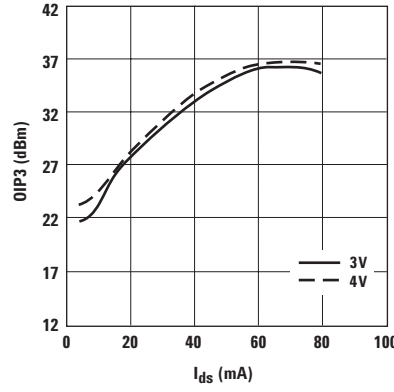

Figure 10. OIP3 vs.  $I_{ds}$  and  $V_{ds}$  Tuned for Max OIP3 and Fmin at 2 GHz.

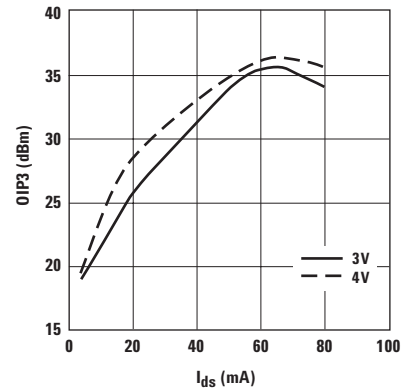

Figure 11. OIP3 vs.  $I_{ds}$  and  $V_{ds}$  Tuned for Max OIP3 and Fmin at 900 MHz.

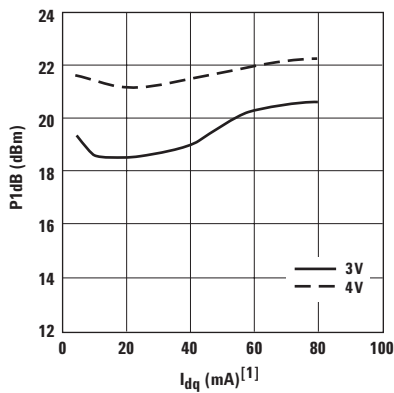

Figure 12. P1dB vs.  $I_{dq}$  and  $V_{ds}$  Tuned for Max OIP3 and Fmin at 2 GHz.

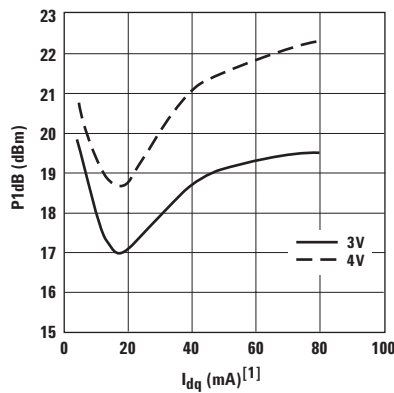

Figure 13. P1dB vs.  $I_{dq}$  and  $V_{ds}$  Tuned for Max OIP3 and Fmin at 900 MHz.

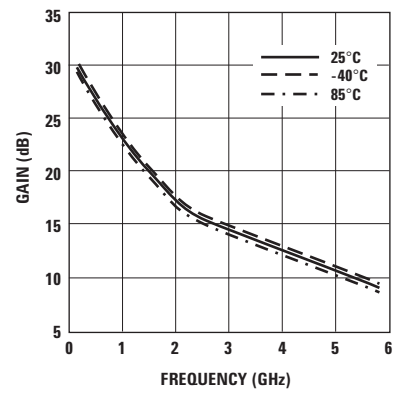

Figure 14. Gain vs. Frequency and Temp Tuned for Max OIP3 and Fmin at 3V, 60 mA.

### Notes:

- $I_{dq}$  represents the quiescent drain current without RF drive applied. Under low values of  $I_{ds}$ , the application of RF drive will cause  $I_d$  to increase substantially as P1dB is approached.
- Fmin values at 2 GHz and higher are based on measurements while the Fmins below 2 GHz have been extrapolated. The Fmin values are

based on a set of 16 noise figure measurements made at 16 different impedances using an ATN NP5 test system. From these measurements a true Fmin is calculated. Refer to the noise parameter application section for more information.

**ATF-54143 Typical Performance Curves, continued**

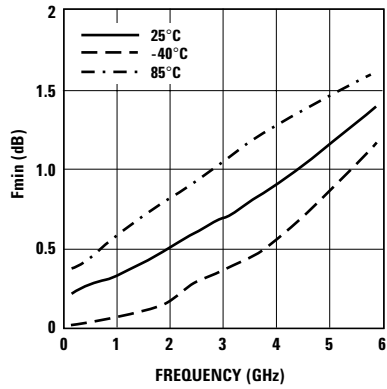

**Figure 15. Fmin<sup>[2]</sup> vs. Frequency and Temp Tuned for Max OIP3 and Fmin at 3V, 60 mA.**

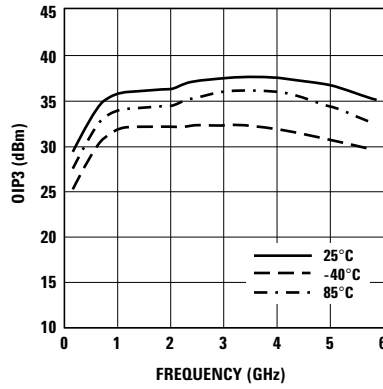

**Figure 16. OIP3 vs. Frequency and Temp Tuned for Max OIP3 and Fmin at 3V, 60 mA.**

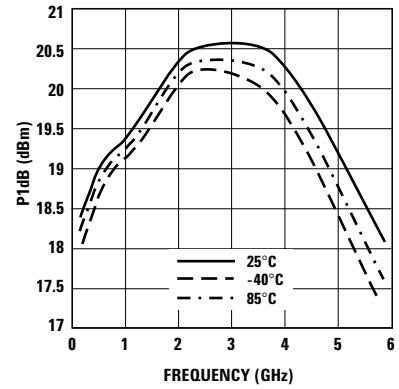

**Figure 17. P1dB vs. Frequency and Temp Tuned for Max OIP3 and Fmin at 3V, 60 mA.**

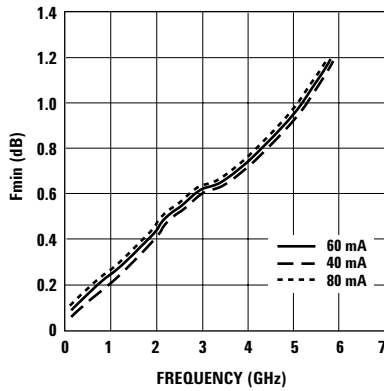

**Figure 18. Fmin<sup>[1]</sup> vs. Frequency and I<sub>ds</sub> at 3V.**

**ATF-54143 Reflection Coefficient Parameters tuned for Maximum Output IP3, V<sub>DS</sub> = 3V, I<sub>DS</sub> = 60 mA**

Freq (GHz)	$\Gamma_{Out\_Mag.}^{[1]}$ (Mag)	$\Gamma_{Out\_Ang.}^{[1]}$ (Degrees)	OIP3 (dBm)	P1dB (dBm)
0.9	0.017	115	35.54	18.4
2.0	0.026	-85	36.23	20.38
3.9	0.013	173	37.54	20.28
5.8	0.025	102	35.75	18.09

**Note:**

- Gamma out is the reflection coefficient of the matching circuit presented to the output of the device.

**Note:**

- Fmin values at 2 GHz and higher are based on measurements while the Fmins below 2 GHz have been extrapolated. The Fmin values are based on a set of 16 noise figure measurements made at 16 different impedances using an ATN NP5 test system. From these measurements a true Fmin is calculated. Refer to the noise parameter application section for more information.

**ATF-54143 Typical Scattering Parameters,  $V_{DS} = 3V, I_{DS} = 40\text{ mA}$**

Freq. GHz	$S_{11}$			$S_{21}$			$S_{12}$		$S_{22}$		MSG/MAG dB
	Mag.	Ang.	dB	Mag.	Ang.	Mag.	Ang.	Mag.	Ang.		
0.1	0.99	-17.6	27.99	25.09	168.5	0.009	80.2	0.59	-12.8	34.45	
0.5	0.83	-76.9	25.47	18.77	130.1	0.036	52.4	0.44	-54.6	27.17	
0.9	0.72	-114	22.52	13.37	108	0.047	40.4	0.33	-78.7	24.54	
1.0	0.70	-120.6	21.86	12.39	103.9	0.049	38.7	0.31	-83.2	24.03	
1.5	0.65	-146.5	19.09	9.01	87.4	0.057	33.3	0.24	-99.5	21.99	
1.9	0.63	-162.1	17.38	7.40	76.6	0.063	30.4	0.20	-108.6	20.70	
2.0	0.62	-165.6	17.00	7.08	74.2	0.065	29.8	0.19	-110.9	20.37	
2.5	0.61	178.5	15.33	5.84	62.6	0.072	26.6	0.15	-122.6	19.09	
3.0	0.61	164.2	13.91	4.96	51.5	0.080	22.9	0.12	-137.5	17.92	
4.0	0.63	138.4	11.59	3.80	31	0.094	14	0.10	176.5	15.33	
5.0	0.66	116.5	9.65	3.04	11.6	0.106	4.2	0.14	138.4	12.99	
6.0	0.69	97.9	8.01	2.51	-6.7	0.118	-6.1	0.17	117.6	11.50	
7.0	0.71	80.8	6.64	2.15	-24.5	0.128	-17.6	0.20	98.6	10.24	
8.0	0.72	62.6	5.38	1.86	-42.5	0.134	-29.3	0.22	73.4	8.83	
9.0	0.76	45.2	4.20	1.62	-60.8	0.145	-40.6	0.27	52.8	8.17	
10.0	0.83	28.2	2.84	1.39	-79.8	0.150	-56.1	0.37	38.3	8.57	
11.0	0.85	13.9	1.42	1.18	-96.9	0.149	-69.3	0.45	25.8	7.47	
12.0	0.88	-0.5	0.23	1.03	-112.4	0.150	-81.6	0.51	12.7	7.50	
13.0	0.89	-15.1	-0.86	0.91	-129.7	0.149	-95.7	0.54	-4.1	6.60	
14.0	0.87	-31.6	-2.18	0.78	-148	0.143	-110.3	0.61	-20.1	4.57	
15.0	0.88	-46.1	-3.85	0.64	-164.8	0.132	-124	0.65	-34.9	3.47	
16.0	0.87	-54.8	-5.61	0.52	-178.4	0.121	-134.6	0.70	-45.6	2.04	
17.0	0.87	-62.8	-7.09	0.44	170.1	0.116	-144.1	0.73	-55.9	1.05	
18.0	0.92	-73.6	-8.34	0.38	156.1	0.109	-157.4	0.76	-68.7	1.90	

**Typical Noise Parameters,  $V_{DS} = 3V, I_{DS} = 40\text{ mA}$**

Freq GHz	$F_{min}$ dB	$\Gamma_{opt}$ Mag.	$\Gamma_{opt}$ Ang.	$R_n/50$	$G_a$ dB
0.5	0.17	0.34	34.80	0.04	27.83
0.9	0.22	0.32	53.00	0.04	23.57
1.0	0.24	0.32	60.50	0.04	22.93
1.9	0.42	0.29	108.10	0.04	18.35
2.0	0.45	0.29	111.10	0.04	17.91
2.4	0.51	0.30	136.00	0.04	16.39
3.0	0.59	0.32	169.90	0.05	15.40
3.9	0.69	0.34	-151.60	0.05	13.26
5.0	0.90	0.45	-119.50	0.09	11.89
5.8	1.14	0.50	-101.60	0.16	10.95
6.0	1.17	0.52	-99.60	0.18	10.64
7.0	1.24	0.58	-79.50	0.33	9.61
8.0	1.57	0.60	-57.90	0.56	8.36
9.0	1.64	0.69	-39.70	0.87	7.77
10.0	1.8	0.80	-22.20	1.34	7.68

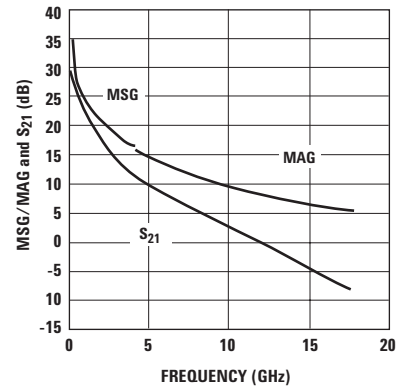

**Figure 19. MSG/MAG and  $|S_{21}|^2$  vs. Frequency at 3V, 40 mA.**

**Notes:**

- $F_{min}$  values at 2 GHz and higher are based on measurements while the  $F_{min}$ s below 2 GHz have been extrapolated. The  $F_{min}$  values are based on a set of 16 noise figure measurements made at 16 different impedances using an ATN NP5 test system. From these measurements a true  $F_{min}$  is calculated. Refer to the noise parameter application section for more information.
- S and noise parameters are measured on a microstrip line made on 0.025 inch thick alumina carrier. The input reference plane is at the end of the gate lead. The output reference plane is at the end of the drain lead. The parameters include the effect of four plated through via holes connecting source landing pads on top of the test carrier to the microstrip ground plane on the bottom side of the carrier. Two 0.020 inch diameter via holes are placed within 0.010 inch from each source lead contact point, one via on each side of that point.

**ATF-54143 Typical Scattering Parameters,  $V_{DS} = 3V, I_{DS} = 60\text{ mA}$**

Freq. GHz	$S_{11}$			$S_{21}$			$S_{12}$		$S_{22}$		MSG/MAG dB
	Mag.	Ang.	dB	Mag.	Ang.	Mag.	Ang.	Mag.	Ang.		
0.1	0.99	-18.9	28.84	27.66	167.6	0.01	80.0	0.54	-14.0	34.42	
0.5	0.81	-80.8	26.04	20.05	128.0	0.03	52.4	0.40	-58.8	28.25	
0.9	0.71	-117.9	22.93	14.01	106.2	0.04	41.8	0.29	-83.8	25.44	
1.0	0.69	-124.4	22.24	12.94	102.2	0.05	40.4	0.27	-88.5	24.13	
1.5	0.64	-149.8	19.40	9.34	86.1	0.05	36.1	0.21	-105.2	22.71	
1.9	0.62	-164.9	17.66	7.64	75.6	0.06	33.8	0.17	-114.7	21.05	
2.0	0.62	-168.3	17.28	7.31	73.3	0.06	33.3	0.17	-117.0	20.86	
2.5	0.60	176.2	15.58	6.01	61.8	0.07	30.1	0.13	-129.7	19.34	
3.0	0.60	162.3	14.15	5.10	51.0	0.08	26.5	0.11	-146.5	18.04	
4.0	0.62	137.1	11.81	3.90	30.8	0.09	17.1	0.10	165.2	14.87	
5.0	0.66	115.5	9.87	3.11	11.7	0.11	6.8	0.14	131.5	13.27	
6.0	0.69	97.2	8.22	2.58	-6.4	0.12	-3.9	0.18	112.4	11.72	
7.0	0.70	80.2	6.85	2.20	-24.0	0.13	-15.8	0.20	94.3	10.22	
8.0	0.72	62.2	5.58	1.90	-41.8	0.14	-28.0	0.23	70.1	9.02	
9.0	0.76	45.0	4.40	1.66	-59.9	0.15	-39.6	0.29	50.6	8.38	
10.0	0.83	28.4	3.06	1.42	-78.7	0.15	-55.1	0.38	36.8	8.71	
11.0	0.85	13.9	1.60	1.20	-95.8	0.15	-68.6	0.46	24.4	7.55	
12.0	0.88	-0.2	0.43	1.05	-111.1	0.15	-80.9	0.51	11.3	7.55	
13.0	0.89	-14.6	-0.65	0.93	-128.0	0.15	-94.9	0.55	-5.2	6.70	
14.0	0.88	-30.6	-1.98	0.80	-146.1	0.14	-109.3	0.61	-20.8	5.01	
15.0	0.88	-45.0	-3.62	0.66	-162.7	0.13	-122.9	0.66	-35.0	3.73	
16.0	0.88	-54.5	-5.37	0.54	-176.6	0.12	-133.7	0.70	-45.8	2.54	
17.0	0.88	-62.5	-6.83	0.46	171.9	0.12	-143.2	0.73	-56.1	1.57	
18.0	0.92	-73.4	-8.01	0.40	157.9	0.11	-156.3	0.76	-68.4	2.22	

**Typical Noise Parameters,  $V_{DS} = 3V, I_{DS} = 60\text{ mA}$**

Freq GHz	$F_{min}$ dB	$\Gamma_{opt}$ Mag.	$\Gamma_{opt}$ Ang.	$R_n/50$	$G_a$ dB
0.5	0.15	0.34	42.3	0.04	28.50
0.9	0.20	0.32	62.8	0.04	24.18
1.0	0.22	0.32	67.6	0.04	23.47
1.9	0.42	0.27	116.3	0.04	18.67
2.0	0.45	0.27	120.1	0.04	18.29
2.4	0.52	0.26	145.8	0.04	16.65
3.0	0.59	0.29	178.0	0.05	15.56
3.9	0.70	0.36	-145.4	0.05	13.53
5.0	0.93	0.47	-116.0	0.10	12.13
5.8	1.16	0.52	-98.9	0.18	11.10
6.0	1.19	0.55	-96.5	0.20	10.95
7.0	1.26	0.60	-77.1	0.37	9.73
8.0	1.63	0.62	-56.1	0.62	8.56
9.0	1.69	0.70	-38.5	0.95	7.97
10.0	1.73	0.79	-21.5	1.45	7.76

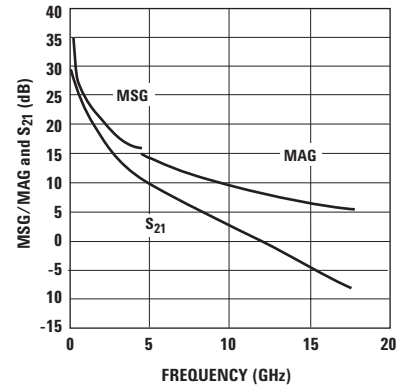

**Figure 20. MSG/MAG and  $|S_{21}|^2$  vs. Frequency at 3V, 60 mA.**

**Notes:**

- $F_{min}$  values at 2 GHz and higher are based on measurements while the  $F_{min}$ s below 2 GHz have been extrapolated. The  $F_{min}$  values are based on a set of 16 noise figure measurements made at 16 different impedances using an ATN NP5 test system. From these measurements a true  $F_{min}$  is calculated. Refer to the noise parameter application section for more information.
- S and noise parameters are measured on a microstrip line made on 0.025 inch thick alumina carrier. The input reference plane is at the end of the gate lead. The output reference plane is at the end of the drain lead. The parameters include the effect of four plated through via holes connecting source landing pads on top of the test carrier to the microstrip ground plane on the bottom side of the carrier. Two 0.020 inch diameter via holes are placed within 0.010 inch from each source lead contact point, one via on each side of that point.



**ATF-54143 Typical Scattering Parameters,  $V_{DS} = 3V, I_{DS} = 80\text{ mA}$**

Freq. GHz	$S_{11}$			$S_{21}$			$S_{12}$		$S_{22}$		MSG/MAG dB
	Mag.	Ang.	dB	Mag.	Ang.	Mag.	Ang.	Mag.	Ang.		
0.1	0.98	-20.4	28.32	26.05	167.1	0.01	79.4	0.26	-27.6	34.16	
0.5	0.80	-85.9	25.32	18.45	126.8	0.04	53.3	0.29	-104.9	26.64	
0.9	0.72	-123.4	22.10	12.73	105.2	0.05	43.9	0.30	-138.8	24.06	
1.0	0.70	-129.9	21.40	11.75	101.3	0.05	42.7	0.30	-144.3	23.71	
1.5	0.66	-154.6	18.55	8.46	85.4	0.06	38.6	0.30	-165.0	21.49	
1.9	0.65	-169.5	16.81	6.92	74.9	0.07	35.7	0.29	-177.6	19.95	
2.0	0.64	-172.8	16.42	6.62	72.6	0.07	35.0	0.29	179.4	19.76	
2.5	0.64	172.1	14.69	5.42	61.1	0.09	30.6	0.29	164.4	17.80	
3.0	0.63	158.5	13.24	4.59	50.1	0.10	25.5	0.29	150.2	16.62	
4.0	0.66	133.8	10.81	3.47	29.9	0.12	13.4	0.33	126.1	14.61	
5.0	0.69	112.5	8.74	2.74	11.1	0.13	1.2	0.39	107.8	12.03	
6.0	0.72	94.3	7.03	2.25	-6.5	0.14	-11.3	0.42	91.8	10.52	
7.0	0.73	77.4	5.63	1.91	-23.5	0.15	-24.5	0.44	75.5	9.12	
8.0	0.74	59.4	4.26	1.63	-41.1	0.16	-38.1	0.47	55.5	7.78	
9.0	0.78	42.1	2.98	1.41	-58.7	0.17	-51.1	0.52	37.8	7.12	
10.0	0.84	25.6	1.51	1.19	-76.4	0.16	-66.8	0.59	24.0	6.96	
11.0	0.86	11.4	0.00	1.00	-92.0	0.16	-79.8	0.64	11.8	6.11	
12.0	0.88	-2.6	-1.15	0.88	-105.9	0.16	-91.7	0.68	-0.8	5.67	
13.0	0.89	-17.0	-2.18	0.78	-121.7	0.15	-105.6	0.70	-16.7	5.08	
14.0	0.87	-33.3	-3.48	0.67	-138.7	0.14	-119.5	0.73	-31.7	3.67	
15.0	0.87	-47.3	-5.02	0.56	-153.9	0.13	-132.3	0.76	-44.9	2.65	
16.0	0.86	-55.6	-6.65	0.47	-165.9	0.12	-141.7	0.78	-54.9	1.48	
17.0	0.86	-63.4	-7.92	0.40	-175.9	0.11	-150.4	0.79	-64.2	0.49	
18.0	0.91	-74.2	-8.92	0.36	171.2	0.10	-163.0	0.81	-76.2	1.29	

**Typical Noise Parameters,  $V_{DS} = 3V, I_{DS} = 80\text{ mA}$**

Freq GHz	$F_{min}$ dB	$\Gamma_{opt}$ Mag.	$\Gamma_{opt}$ Ang.	$R_n/50$	$G_a$ dB
0.5	0.19	0.23	66.9	0.04	27.93
0.9	0.24	0.24	84.3	0.04	24.13
1.0	0.25	0.25	87.3	0.04	23.30
1.9	0.43	0.28	134.8	0.04	18.55
2.0	0.42	0.29	138.8	0.04	18.15
2.4	0.51	0.30	159.5	0.03	16.44
3.0	0.61	0.35	-173	0.03	15.13
3.9	0.70	0.41	-141.6	0.06	12.97
5.0	0.94	0.52	-113.5	0.13	11.42
5.8	1.20	0.56	-97.1	0.23	10.48
6.0	1.26	0.58	-94.8	0.26	10.11
7.0	1.34	0.62	-75.8	0.46	8.86
8.0	1.74	0.63	-55.5	0.76	7.59
9.0	1.82	0.71	-37.7	1.17	6.97
10.0	1.94	0.79	-20.8	1.74	6.65

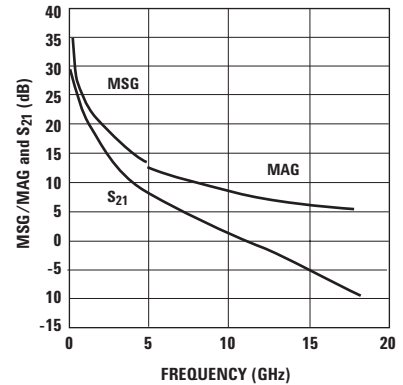

**Figure 21. MSG/MAG and  $|S_{21}|^2$  vs. Frequency at 3V, 80 mA.**

**Notes:**

- $F_{min}$  values at 2 GHz and higher are based on measurements while the  $F_{min}$ s below 2 GHz have been extrapolated. The  $F_{min}$  values are based on a set of 16 noise figure measurements made at 16 different impedances using an ATN NP5 test system. From these measurements a true  $F_{min}$  is calculated. Refer to the noise parameter application section for more information.
- S and noise parameters are measured on a microstrip line made on 0.025 inch thick alumina carrier. The input reference plane is at the end of the gate lead. The output reference plane is at the end of the drain lead. The parameters include the effect of four plated through via holes connecting source landing pads on top of the test carrier to the microstrip ground plane on the bottom side of the carrier. Two 0.020 inch diameter via holes are placed within 0.010 inch from each source lead contact point, one via on each side of that point.

**ATF-54143 Typical Scattering Parameters,  $V_{DS} = 4V, I_{DS} = 60\text{ mA}$**

Freq. GHz	$S_{11}$			$S_{21}$			$S_{12}$			$S_{22}$			MSG/MAG dB
	Mag.	Ang.	dB	Mag.	Ang.	Mag.	Ang.	Mag.	Ang.	Mag.	Ang.		
0.1	0.99	-18.6	28.88	27.80	167.8	0.01	80.1	0.58	-12.6	34.44			
0.5	0.81	-80.2	26.11	20.22	128.3	0.03	52.4	0.42	-52.3	28.29			
0.9	0.71	-117.3	23.01	14.15	106.4	0.04	41.7	0.31	-73.3	25.49			
1.0	0.69	-123.8	22.33	13.07	102.4	0.04	40.2	0.29	-76.9	25.14			
1.5	0.64	-149.2	19.49	9.43	86.2	0.05	36.1	0.22	-89.4	22.76			
1.9	0.62	-164.5	17.75	7.72	75.7	0.06	34.0	0.18	-95.5	21.09			
2.0	0.61	-167.8	17.36	7.38	73.3	0.06	33.5	0.18	-97.0	20.90			
2.5	0.60	176.6	15.66	6.07	61.9	0.07	30.7	0.14	-104.0	19.38			
3.0	0.60	162.6	14.23	5.15	51.1	0.07	27.3	0.11	-113.4	18.67			
4.0	0.62	137.4	11.91	3.94	30.9	0.09	18.7	0.07	-154.7	15.46			
5.0	0.65	115.9	10.00	3.16	11.7	0.10	9.0	0.09	152.5	13.20			
6.0	0.68	97.6	8.36	2.62	-6.6	0.11	-1.4	0.12	127.9	11.73			
7.0	0.70	80.6	7.01	2.24	-24.3	0.12	-12.9	0.15	106.9	10.47			
8.0	0.72	62.6	5.76	1.94	-42.3	0.13	-24.7	0.17	78.9	9.31			
9.0	0.76	45.4	4.60	1.70	-60.5	0.14	-36.1	0.23	56.8	8.69			
10.0	0.83	28.5	3.28	1.46	-79.6	0.15	-51.8	0.32	42.1	9.88			
11.0	0.86	14.1	1.87	1.24	-97.0	0.15	-65.4	0.41	29.4	9.17			
12.0	0.88	-0.4	0.69	1.08	-112.8	0.15	-78.0	0.47	16.0	8.57			
13.0	0.90	-14.9	-0.39	0.96	-130.2	0.15	-92.2	0.51	-1.1	8.06			
14.0	0.87	-31.4	-1.72	0.82	-148.8	0.15	-107.3	0.58	-17.6	4.90			
15.0	0.88	-46.0	-3.38	0.68	-166.0	0.14	-121.2	0.63	-32.6	3.86			
16.0	0.88	-54.8	-5.17	0.55	179.8	0.13	-132.2	0.69	-43.7	2.65			
17.0	0.87	-62.8	-6.73	0.46	168.4	0.12	-142.3	0.72	-54.2	1.33			
18.0	0.92	-73.7	-7.93	0.40	154.3	0.11	-155.6	0.75	-67.2	2.26			

**Typical Noise Parameters,  $V_{DS} = 4V, I_{DS} = 60\text{ mA}$**

Freq GHz	$F_{min}$ dB	$\Gamma_{opt}$ Mag.	$\Gamma_{opt}$ Ang.	$R_n/50$	$G_a$ dB
0.5	0.17	0.33	34.30	0.03	28.02
0.9	0.25	0.31	60.30	0.04	24.12
1.0	0.27	0.31	68.10	0.04	23.43
1.9	0.45	0.27	115.00	0.04	18.72
2.0	0.49	0.27	119.80	0.04	18.35
2.4	0.56	0.26	143.50	0.04	16.71
3.0	0.63	0.28	176.80	0.04	15.58
3.9	0.73	0.35	-145.90	0.05	13.62
5.0	0.96	0.47	-116.20	0.11	12.25
5.8	1.20	0.52	-98.80	0.19	11.23
6.0	1.23	0.54	-96.90	0.21	11.02
7.0	1.33	0.60	-77.40	0.38	9.94
8.0	1.66	0.63	-56.20	0.64	8.81
9.0	1.71	0.71	-38.60	0.99	8.22
10.0	1.85	0.82	-21.30	1.51	8.12

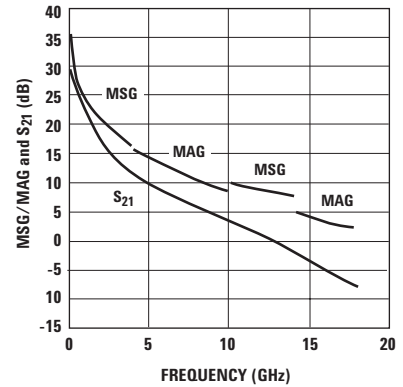

**Figure 22. MSG/MAG and  $|S_{21}|^2$  vs. Frequency at 4V, 60 mA.**

**Notes:**

- $F_{min}$  values at 2 GHz and higher are based on measurements while the  $F_{min}$ s below 2 GHz have been extrapolated. The  $F_{min}$  values are based on a set of 16 noise figure measurements made at 16 different impedances using an ATN NP5 test system. From these measurements a true  $F_{min}$  is calculated. Refer to the noise parameter application section for more information.
- S and noise parameters are measured on a microstrip line made on 0.025 inch thick alumina carrier. The input reference plane is at the end of the gate lead. The output reference plane is at the end of the drain lead. The parameters include the effect of four plated through via holes connecting source landing pads on top of the test carrier to the microstrip ground plane on the bottom side of the carrier. Two 0.020 inch diameter via holes are placed within 0.010 inch from each source lead contact point, one via on each side of that point.

## ATF-54143 Applications Information

### Introduction

Agilent Technologies's ATF-54143 is a low noise enhancement mode PHEMT designed for use in low cost commercial applications in the VHF through 6 GHz frequency range. As opposed to a typical depletion mode PHEMT where the gate must be made negative with respect to the source for proper operation, an enhancement mode PHEMT requires that the gate be made more positive than the source for normal operation. Therefore a negative power supply voltage is not required for an enhancement mode device. Biasing an enhancement mode PHEMT is much like biasing the typical bipolar junction transistor. Instead of a 0.7V base to emitter voltage, the ATF-54143 enhancement mode PHEMT requires about a 0.6V potential between the gate and source for a nominal drain current of 60 mA.

### Matching Networks

The techniques for impedance matching an enhancement mode device are very similar to those for matching a depletion mode device. The only difference is in the method of supplying gate bias. S and Noise Parameters for various bias conditions are listed in this data sheet. The circuit shown in Figure 1 shows a typical LNA circuit normally used for 900 and 1900 MHz applications (Consult the Agilent Technologies website for application notes covering specific applications). High pass impedance matching networks consisting of L1/C1 and L4/C4 provide the appropriate match for noise figure, gain, S11 and S22. The high pass structure also provides low frequency gain reduction which can be beneficial from the standpoint of improving out-of-band rejection at lower frequencies.

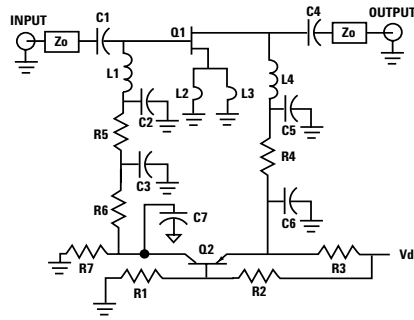

Figure 1. Typical ATF-54143 LNA with Passive Biasing.

Capacitors C2 and C5 provide a low impedance in-band RF bypass for the matching networks. Resistors R3 and R4 provide a very important low frequency termination for the device. The resistive termination improves low frequency stability. Capacitors C3 and C6 provide the low frequency RF bypass for resistors R3 and R4. Their value should be chosen carefully as C3 and C6 also provide a termination for low frequency mixing products. These mixing products are as a result of two or more in-band signals mixing and producing third order in-band distortion products. The low frequency or difference mixing products are bypassed by C3 and C6. For best suppression of third order distortion products based on the CDMA 1.25 MHz signal spacing, C3 and C6 should be 0.1  $\mu$ F in value. Smaller values of capacitance will not suppress the generation of the 1.25 MHz difference signal and as a result will show up as poorer two tone IP3 results.

### Bias Networks

One of the major advantages of the enhancement mode technology is that it allows the designer to be able to dc ground the source leads and then merely apply a positive voltage on the gate to set the desired amount of quiescent drain current  $I_d$ .

Whereas a depletion mode PHEMT pulls maximum drain current when  $V_{gs} = 0V$ , an enhancement mode PHEMT pulls only a small amount of leakage current when  $V_{gs} = 0V$ . Only when  $V_{gs}$  is increased above  $V_{to}$ , the device threshold voltage, will drain current start to flow. At a  $V_{ds}$  of 3V and a nominal  $V_{gs}$  of 0.6V, the drain current  $I_d$  will be approximately 60 mA. The data sheet suggests a minimum and maximum  $V_{gs}$  over which the desired amount of drain current will be achieved. It is also important to note that if the gate terminal is left open circuited, the device will pull some amount of drain current due to leakage current creating a voltage differential between the gate and source terminals.

### Passive Biasing

Passive biasing of the ATF-54143 is accomplished by the use of a voltage divider consisting of R1 and R2. The voltage for the divider is derived from the drain voltage which provides a form of voltage feedback through the use of R3 to help keep drain current constant. Resistor R3 (approximately 10k $\Omega$ ) provides current limiting for the gate of enhancement mode devices such as the ATF-54143. This is especially important when the device is driven to  $P_{1dB}$  or  $P_{SAT}$ .

Resistor R3 is calculated based on desired  $V_{ds}$ ,  $I_{ds}$  and available power supply voltage.

$$R3 = \frac{V_{DD} - V_{ds}}{I_{ds} + I_{BB}} \quad (1)$$

$V_{DD}$  is the power supply voltage.  
 $V_{ds}$  is the device drain to source voltage.

$I_{ds}$  is the desired drain current.  
 $I_{BB}$  is the current flowing through the R1/R2 resistor voltage divider network.

The values of resistors R1 and R2 are calculated with the following formulas

$$R1 = \frac{V_{gs}}{I_{BB}} \quad (2)$$

$$R2 = \frac{(V_{ds} - V_{gs}) R1}{V_{gs}} \quad (3)$$

#### Example Circuit

$$\begin{aligned} V_{DD} &= 5V \\ V_{ds} &= 3V \\ I_{ds} &= 60 \text{ mA} \\ V_{gs} &= 0.59V \end{aligned}$$

Choose  $I_{BB}$  to be at least 10X the normal expected gate leakage current.  $I_{BB}$  was chosen to be 2 mA for this example. Using equations (1), (2), and (3) the resistors are calculated as follows

$$\begin{aligned} R1 &= 295\Omega \\ R2 &= 1205\Omega \\ R3 &= 32.3\Omega \end{aligned}$$

#### Active Biasing

Active biasing provides a means of keeping the quiescent bias point constant over temperature and constant over lot to lot variations in device dc performance. The advantage of the active biasing of an enhancement mode PHEMT versus a depletion mode PHEMT is that a negative power source is not required. The techniques of active biasing an enhancement mode device are very similar to those used to bias a bipolar junction transistor.

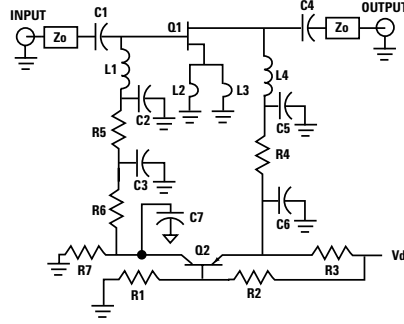

Figure 2. Typical ATF-54143 LNA with Active Biasing.

An active bias scheme is shown in Figure 2. R1 and R2 provide a constant voltage source at the base of a PNP transistor at Q2. The constant voltage at the base of Q2 is raised by 0.7 volts at the emitter. The constant emitter voltage plus the regulated  $V_{DD}$  supply are present across resistor R3. Constant voltage across R3 provides a constant current supply for the drain current. Resistors R1 and R2 are used to set the desired  $V_{ds}$ . The combined series value of these resistors also sets the amount of extra current consumed by the bias network. The equations that describe the circuit's operation are as follows.

$$V_E = V_{ds} + (I_{ds} \cdot R4) \quad (1)$$

$$R3 = \frac{V_{DD} - V_E}{I_{ds}} \quad (2)$$

$$V_B = V_E - V_{BE} \quad (3)$$

$$V_B = \frac{R1}{R1 + R2} V_{DD} \quad (4)$$

$$V_{DD} = I_{BB} (R1 + R2) \quad (5)$$

Rearranging equation (4) provides the following formula

$$R2 = \frac{R1 (V_{DD} - V_B)}{V_B} \quad (4A)$$

and rearranging equation (5) provides the following formula

$$R1 = \frac{V_{DD}}{I_{BB} \left(1 + \frac{V_{DD} - V_B}{V_B}\right)} \quad (5A)$$

#### Example Circuit

$$\begin{aligned} V_{DD} &= 5V \\ V_{ds} &= 3V \\ I_{ds} &= 60 \text{ mA} \\ R4 &= 10\Omega \\ V_{BE} &= 0.7V \end{aligned}$$

Equation (1) calculates the required voltage at the emitter of the PNP transistor based on desired  $V_{ds}$  and  $I_{ds}$  through resistor R4 to be 3.6V. Equation (2) calculates the value of resistor R3 which determines the drain current  $I_{ds}$ . In the example  $R3=23.3\Omega$ . Equation (3) calculates the voltage required at the junction of resistors R1 and R2. This voltage plus the step-up of the base emitter junction determines the regulated  $V_{ds}$ . Equations (4) and (5) are solved simultaneously to determine the value of resistors R1 and R2. In the example  $R1=1450\Omega$  and  $R2=1050\Omega$ . R7 is chosen to be 1k $\Omega$ . This resistor keeps a small amount of current flowing through Q2 to help maintain bias stability. R6 is chosen to be 10k $\Omega$ . This value of resistance is necessary to limit Q1 gate current in the presence of high RF drive level (especially when Q1 is driven to  $P_{1dB}$  gain compression point).

# ATF-54143 Die Model

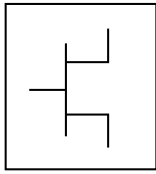

Advanced\_Curtice2\_Model

```

MESFETM1
NFET=yes           Rf=           Crf=0.1 F           N=
PFET=no            Gscap=2         Gsfwd=           Fnc=1 MHz
Vto=0.3            Cgs=1.73 pF        Gsrev=           R=0.08
Beta=0.9           Cgd=0.255 pF      Gdfwd=           P=0.2
Lambda=82e-3       Gdcap=2           Gdrev=           C=0.1
Alpha=13           Fc=0.65           R1=              Taumdl=no
Tau=               Rgd=0.25 Ohm      R2=              wVgfd=
Tnom=16.85         Rd=1.0125 Ohm     Vbi=0.8          wBvgs=
Idstc=             Rg=1.0 Ohm        Vbr=             wBvgd=
Ucrit=-0.72        Rs=0.3375 Ohm     Vjr=             wBvds=
Vgexp=1.91         Ld=               Is=              wldsmx=
Gamds=1e-4         Lg=0.18 nH        lr=              wPmax=
Vtotc=             Betatce=          Lmax=            AllParams=
Rs=0.25 Ohm        Cds=0.27 pF       Xti=
Rc=250 Ohm         Eg=
    
```

# ATF-54143 curtice ADS Model

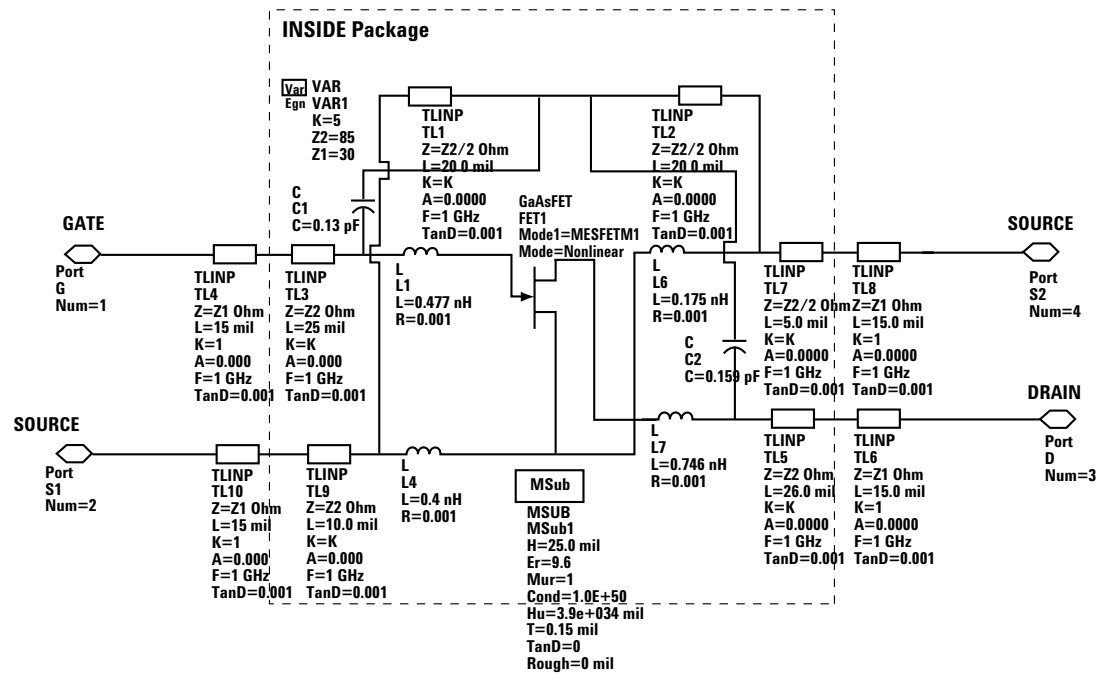

### Designing with S and Noise Parameters and the Non-Linear Model

The non-linear model describing the ATF-54143 includes both the die and associated package model. The package model includes the effect of the pins but does not include the effect of the additional source inductance associated with grounding the source leads through the printed circuit board. The device S and Noise Parameters do include the effect of 0.020 inch thickness printed circuit board vias. When comparing simulation results between the measured S param-

eters and the simulated non-linear model, be sure to include the effect of the printed circuit board to get an accurate comparison. This is shown schematically in Figure 3.

#### For Further Information

The information presented here is an introduction to the use of the ATF-54143 enhancement mode PHEMT. More detailed application circuit information is available from Agilent Technologies. Consult the web page or your local Agilent Technologies sales representative.

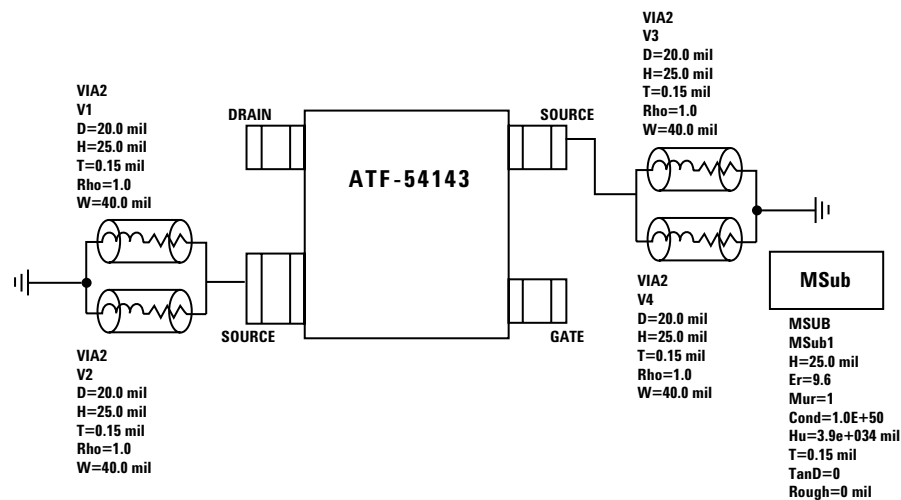

Figure 3. Adding Vias to the ATF-54143 Non-Linear Model for Comparison to Measured S and Noise Parameters.

## Noise Parameter Applications Information

$F_{\min}$  values at 2 GHz and higher are based on measurements while the  $F_{\min}$ s below 2 GHz have been extrapolated. The  $F_{\min}$  values are based on a set of 16 noise figure measurements made at 16 different impedances using an ATN NP5 test system. From these measurements, a true  $F_{\min}$  is calculated.  $F_{\min}$  represents the true minimum noise figure of the device when the device is presented with an impedance matching network that transforms the source impedance, typically  $50\Omega$ , to an impedance represented by the reflection coefficient  $\Gamma_o$ . The designer must design a matching network that will present  $\Gamma_o$  to the device with minimal associated circuit losses. The noise figure of the completed amplifier is equal to the noise figure of the device plus the losses of the matching network preceding the device. The noise figure of the device is equal to  $F_{\min}$  only when the device is presented with  $\Gamma_o$ .

If the reflection coefficient of the matching network is other than  $\Gamma_o$ , then the noise figure of the device will be greater than  $F_{\min}$  based on the following equation.

$$NF = F_{\min} + 4 \frac{R_n}{Z_o} \frac{|\Gamma_s - \Gamma_o|^2}{(1 + |\Gamma_o|^2)(1 - |\Gamma_s|^2)}$$

Where  $R_n/Z_o$  is the normalized noise resistance,  $\Gamma_o$  is the optimum reflection coefficient required to produce  $F_{\min}$  and  $\Gamma_s$  is the reflection coefficient of the source impedance actually presented to the device. The losses of the matching networks are non-zero and they will also add to the noise figure of the device creating a higher amplifier noise figure. The losses of the matching networks are related to the Q of the components and associated printed circuit board loss.  $\Gamma_o$  is typically fairly low at higher frequencies and increases as frequency is lowered. Larger gate width devices will typically have a lower  $\Gamma_o$  as compared to narrower gate width devices. Typically for FETs, the higher  $\Gamma_o$  usually infers that an impedance

much higher than  $50\Omega$  is required for the device to produce  $F_{\min}$ . At VHF frequencies and even lower L Band frequencies, the required impedance can be in the vicinity of several thousand ohms. Matching to such a high impedance requires very hi-Q components in order to minimize circuit losses. As an example at 900 MHz, when airwound coils ( $Q > 100$ ) are used for matching networks, the loss can still be up to 0.25 dB which will add directly to the noise figure of the device. Using multilayer molded inductors with Qs in the 30 to 50 range results in additional loss over the airwound coil. Losses as high as 0.5 dB or greater add to the typical 0.15 dB  $F_{\min}$  of the device creating an amplifier noise figure of nearly 0.65 dB. A discussion concerning calculated and measured circuit losses and their effect on amplifier noise figure is covered in Agilent Application 1085.

## Ordering Information

Part Number	No. of Devices	Container
ATF-54143-TR1	3000	7" Reel
ATF-54143-TR2	10000	13" Reel
ATF-54143-BLK	100	antistatic bag
ATF-54143-TR1G	3000	7" Reel
ATF-54143-TR2G	10000	13" Reel
ATF-54143-BLKG	100	antistatic bag

**Note:** For lead-free option, the part number will have the character "G" at the end.

## Package Dimensions Outline 43 (SO<sup>8</sup>-343/SC70 4 lead)

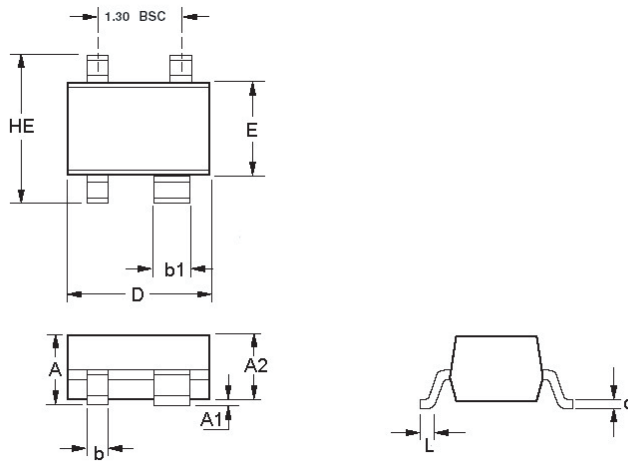

### Dimensions

Symbol	Min (mm)	Max (mm)
E	1.15	1.35
D	1.85	2.25
HE	1.80	2.40
A	0.80	1.10
A2	0.80	1.00
A1	0.00	0.10
b	0.25	0.40
b1	0.55	0.70
c	0.10	0.20
L	0.10	0.46

### Note:

1. All dimensions are in mm.
2. Dimensions are inclusive of plating.
3. Dimensions are exclusive of mold flash and metal burr.
4. All specifications comply with EIAJ SC70.
5. Die is facing up for mold and facing down for trim/form, i.e., reverse trim/form.
6. Package surface to be mirror finish.



**Recommended PCB Pad Layout for Agilent's SC70 4L/SOT-343 Products**

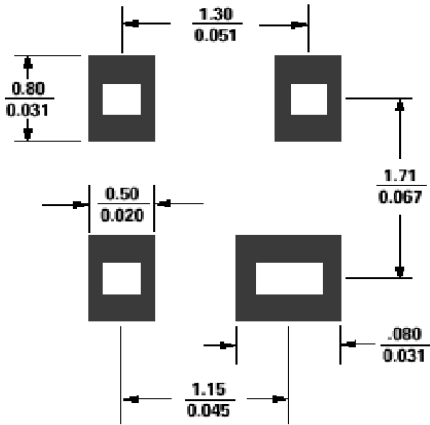

(dimensions in inches/mm)

**Device Orientation**

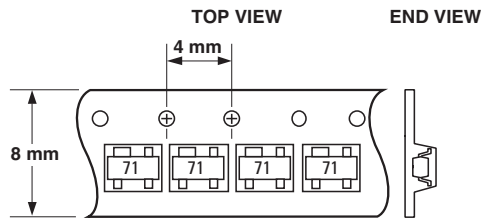
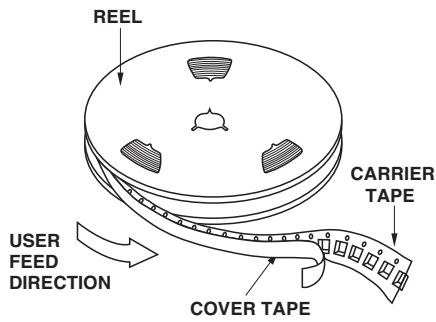

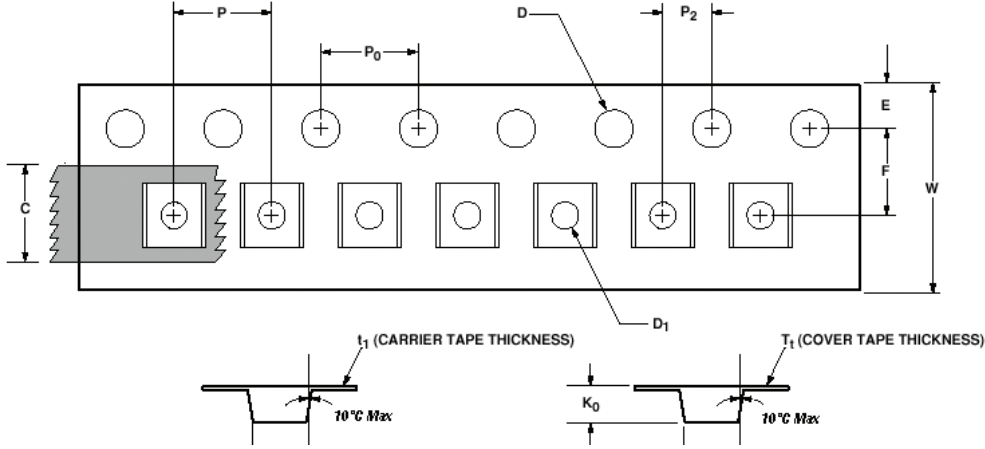

### Tape Dimensions and Product Orientation

Description		Symbol	Size (mm)	Size (inches)
Cavity	Length	$A_0$	$2.40 \pm 0.10$	$0.094 \pm 0.004$
	Width	$B_0$	$2.40 \pm 0.10$	$0.094 \pm 0.004$
	Depth	$K_0$	$1.20 \pm 0.10$	$0.047 \pm 0.004$
	Pitch	P	$4.00 \pm 0.10$	$0.157 \pm 0.004$
	Bottom Hole Diameter	$D_1$	$1.00 + 0.25$	$0.039 + 0.010$
Perforation	Diameter	D	$1.50 + 0.10$	$0.061 + 0.002$
	Pitch	$P_0$	$4.00 \pm 0.10$	$0.157 \pm 0.004$
	Position	E	$1.75 \pm 0.10$	$0.069 \pm 0.004$
Carrier Tape	Width	W	$8.00 + 0.30 - 0.10$	$0.315 + 0.012$
	Thickness	$t_1$	$0.254 \pm 0.02$	$0.0100 \pm 0.0008$
Cover Tape	Width	C	$5.40 \pm 0.010$	$0.205 + 0.004$
	Thickness	$T_t$	$0.062 \pm 0.001$	$0.0025 \pm 0.0004$
Distance	Cavity to Perforation (Width Direction)	F	$3.50 \pm 0.05$	$0.138 \pm 0.002$
	Cavity to Perforation (Length Direction)	$P_2$	$2.00 \pm 0.05$	$0.079 \pm 0.002$

For product information and a complete list of Agilent contacts and distributors, please go to our web site.

[www.agilent.com/semiconductors](http://www.agilent.com/semiconductors)

E-mail: SemiconductorSupport@agilent.com

Data subject to change.

Copyright © 2004 Agilent Technologies, Inc.

Obsoletes 5989-0034EN

December 10, 2004

5989-1922EN



**Agilent Technologies**