



Chipsmall Limited consists of a professional team with an average of over 10 year of expertise in the distribution of electronic components. Based in Hongkong, we have already established firm and mutual-benefit business relationships with customers from,Europe,America and south Asia,supplying obsolete and hard-to-find components to meet their specific needs.

With the principle of "Quality Parts,Customers Priority,Honest Operation,and Considerate Service",our business mainly focus on the distribution of electronic components. Line cards we deal with include Microchip,ALPS,ROHM,Xilinx,Pulse,ON,Everlight and Freescale. Main products comprise IC,Modules,Potentiometer,IC Socket,Relay,Connector.Our parts cover such applications as commercial,industrial, and automotives areas.

We are looking forward to setting up business relationship with you and hope to provide you with the best service and solution. Let us make a better world for our industry!



## Contact us

Tel: +86-755-8981 8866 Fax: +86-755-8427 6832

Email & Skype: info@chipsmall.com Web: www.chipsmall.com

Address: A1208, Overseas Decoration Building, #122 Zhenhua RD., Futian, Shenzhen, China



---

**High Performance Electrically-Erasable PLD**

---

**DATASHEET**

---

**Features**

---

- Industry Standard Architecture
  - Emulates Many 20-pin PALs®
  - Low-cost, Easy to Use Software Tools
- High Speed Electrically-Erasable Programmable Logic Devices (EE PLD)
  - 5ns Maximum Pin-to-pin Delay
- Low Power, 100µA Pin Controlled Power-down Mode Option
- CMOS and TTL Compatible Inputs and Outputs
  - Input and I/O Pin Keeper Circuits
- Advanced Flash Technology
  - Reprogrammable
  - 100% Tested
- High Reliability CMOS Process
  - 20 Year Data Retention
  - 100 Erase/Write Cycles
  - 2,000V ESD Protection
  - 200mA Latchup Immunity
- Commercial and Industrial Temperature Ranges
- Dual-in-line and Surface Mount Packages in Standard Pinouts
- PCI Compliant
- Green (ROHS Compliant) Package Options Available

---

**Description**

---

The Atmel® ATF16V8C is a high performance EECMOS Programmable Logic Device (PLD) which utilizes the Atmel proven Electrically-Erasable (EE) Flash memory technology. Offered options include speeds down to 5ns and a 100µA pin-controlled power-down mode. All speed ranges are specified over the full 5V ± 10% range for industrial temperature range, and 5V ± 5% for commercial range 5V devices.

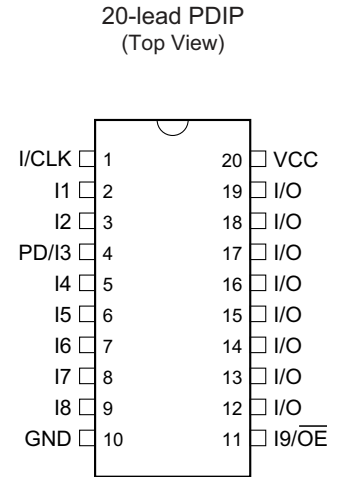
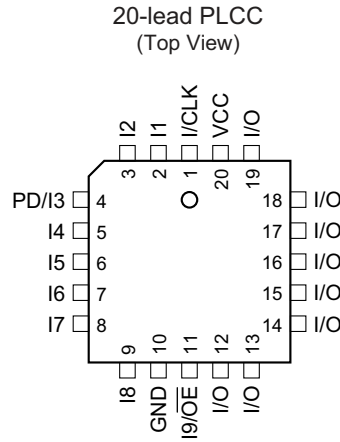
The ATF16V8C incorporates a super set of the generic architectures, which allows direct replacement of the 16R8 family and most 20-pin combinatorial PLDs. Eight outputs are each allocated eight product terms. Three different modes of operation are configured automatically with software and allow highly complex logic functions to be realized.

The ATF16V8C can significantly reduce total system power, thereby enhancing system reliability and reducing power supply costs. When Pin 4 is configured as the power-down control pin, supply current drops to less than 100µA whenever the pin is high. If the power-down feature isn't required for a particular application, Pin 4 may be used as a logic input. Also, the pin-keeper circuits eliminate the need for external pull-up resistors along with their attendant power consumption.

# 1. Pin Configurations and Pinouts

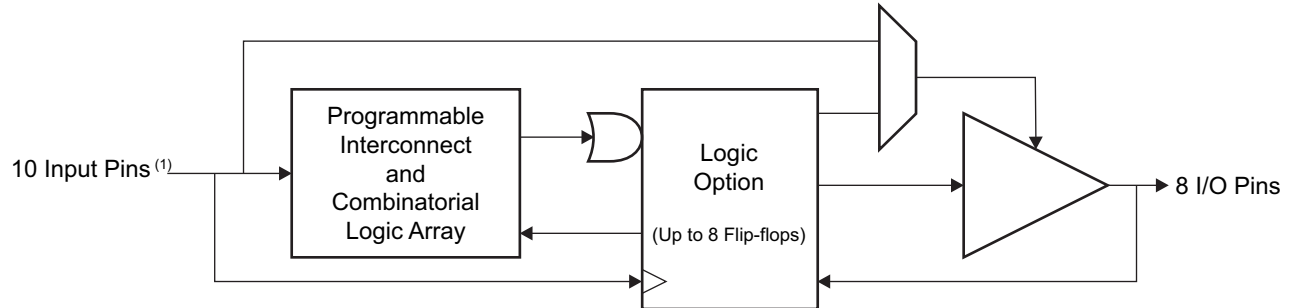
Figure 1-1. Pin Configurations and Pinouts

Pin	Function
CLK	Clock
I	Logic Inputs
I/O	Bidirectional Buffers
$\overline{OE}$	Output Enable
V <sub>CC</sub>	+5V Supply
PD	Power-Down
GND	Ground



# 2. Block Diagram

Figure 2-1. Block Diagram



Note: 1. Includes optional PD control pin.

### 3. Electrical Characteristics

#### 3.1 Absolute Maximum Ratings\*

Temperature Under Bias . . . . .	-40°C to +85°C
Storage Temperature . . . . .	-65°C to +150°C
Voltage on Any Pin with Respect to Ground . . . . .	-2.0V to +7.0V <sup>(1)</sup>
Voltage on Input Pins with Respect to Ground During Programming . . . . .	-2.0V to +14.0V <sup>(1)</sup>
Programming Voltage with Respect to Ground . . . . .	-2.0V to +14.0V <sup>(1)</sup>

\*Notice: Stresses beyond those listed under “Absolute maximum ratings” may cause permanent damage to the device. This is a stress rating only, and functional operation of the device at these or any other conditions beyond those indicated in the operational sections of this specification is not implied. Exposure to absolute maximum rating conditions for extended periods may affect device reliability.

Note: 1. Minimum voltage is -0.6V DC, which may undershoot to -2.0V for pulses of less than 20ns. Maximum output pin voltage is  $V_{CC} + 0.75V$  DC, which may overshoot to 7.0V for pulses of less than 20ns.

#### 3.2 Pin Capacitance

Table 3-1. Pin Capacitance

	Typ	Max	Units	Conditions
$C_{IN}$	5	8	pF	$V_{IN} = 0V$
$C_{OUT}$	6	8	pF	$V_{OUT} = 0V$

Note: 1. Typical values for nominal supply voltage. This parameter is only sampled and is not 100% tested.

#### 3.3 DC and AC Operating Conditions

Table 3-2. DC and AC Operating Conditions

	Commercial	Industrial
Operating Temperature (Ambient)	0°C to 70°C	-40°C to 85°C
$V_{CC}$ Power Supply	5V ± 5%	5V ± 10%

## 3.4 DC Characteristics

Figure 3-1. DC Characteristics

Symbol	Parameter	Condition	Min	Typ	Max	Units
$I_{IL}$	Input or I/O Low Leakage Current	$0 \leq V_{IN} \leq V_{IL} \text{ (Max)}$			-10.0	$\mu\text{A}$
$I_{IH}$	Input or I/O High Leakage Current	$3.5 \leq V_{IN} \leq V_{CC}$			10.0	$\mu\text{A}$
$I_{CC1}^{(1)}$	Power Supply Current, Standby	15MHz, $V_{CC} = \text{Max}$ , $V_{IN} = 0$ , $V_{CC}$ , Outputs Open	Com.		115	mA
			Ind.		130	mA
$I_{PD}$	Power Supply Current, Power-down Mode	$V_{CC} = \text{Max}$ , $V_{IN} = 0$ , $V_{CC}$	Com.	10	100	$\mu\text{A}$
			Ind.	10	105	$\mu\text{A}$
$I_{OS}$	Output Short Circuit Current	$V_{OUT} = 0.5\text{V}$ ; $V_{CC} = 5\text{V}$ ; $T_A = 25^\circ\text{C}$			-150	mA
$V_{IL}$	Input Low Voltage	$\text{Min} < V_{CC} < \text{Max}$	-0.5		0.8	V
$V_{IH}$	Input High Voltage		2.0		$V_{CC} + 1$	V
$V_{OL}$	Output Low Voltage	$V_{CC} = \text{Min}$ ; All Outputs $I_{OL} = 24\text{mA}$	Com., Ind.		0.5	V
$V_{OH}$	Output High Voltage	$V_{CC} = \text{Min}$ $I_{OL} = -4.0\text{mA}$		2.4		V
$I_{OL}$	Output Low Current	$V_{CC} = \text{Min}$	Com.	24.0		mA
			Ind.	12.0		mA
$I_{OH}$	Output High Current	$V_{CC} = \text{Min}$	Com., Ind.	-4.0		mA

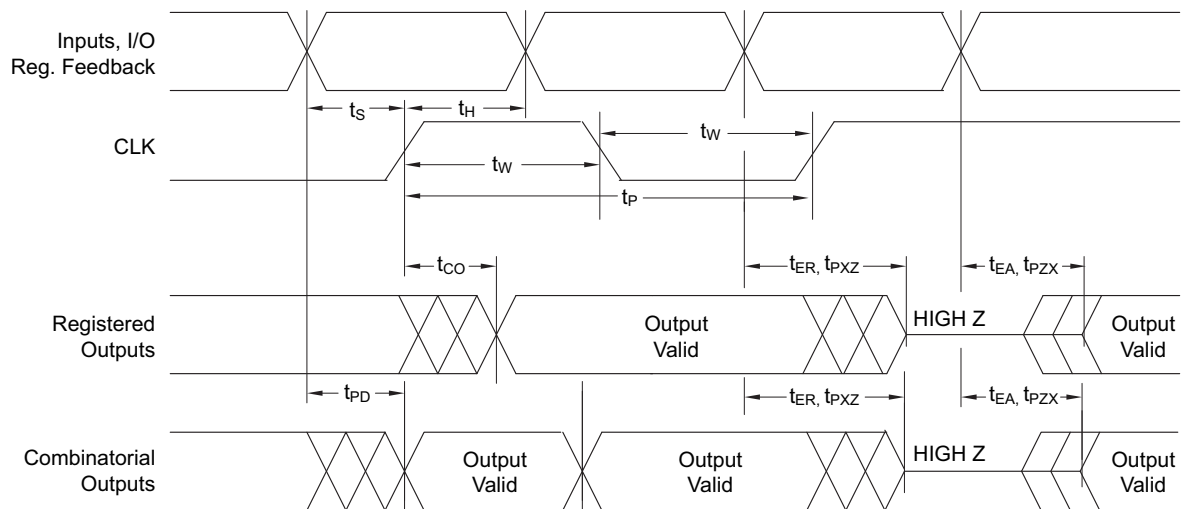
Note: 1. All  $I_{CC}$  parameters measured with outputs open.

### 3.5 AC Characteristics

**Table 3-3. AC Characteristics**

Symbol	Parameter	-5		-7		Units
		Min	Max	Min	Max	
$t_{PD}$	Input or Feedback to Non-registered Output	1	5	3	7.5	ns
$t_{CF}$	Clock to Feedback		3		3	ns
$t_{CO}$	Clock to Output	1	4	2	5	ns
$t_S$	Input or Feedback Setup Time	3		5		ns
$t_H$	Input Hold Time	0		0		ns
$t_P$	Clock Period	6		8		ns
$t_W$	Clock Width	3		4		ns
$f_{MAX}$	External Feedback $1/(t_S + t_{CO})$		142		100	MHz
	Internal Feedback $1/(t_S + t_{CF})$		166		125	MHz
	No Feedback $1/(t_P)$		166		125	MHz
$t_{EA}$	Input to Output Enable – Product Term	2	6	3	9	ns
$t_{ER}$	Input to Output Disable – Product Term	2	5	2	9	ns
$t_{PZX}$	$\overline{OE}$ Pin to Output Enable	2	5	2	6	ns
$t_{PXZ}$	$\overline{OE}$ Pin to Output Disable	1.5	5	1.5	6	ns

**Figure 3-2. AC Waveforms**



Note: 1. Timing measurement reference is 1.5V. Input AC driving levels are 0.0V and 3.0V, unless otherwise specified.

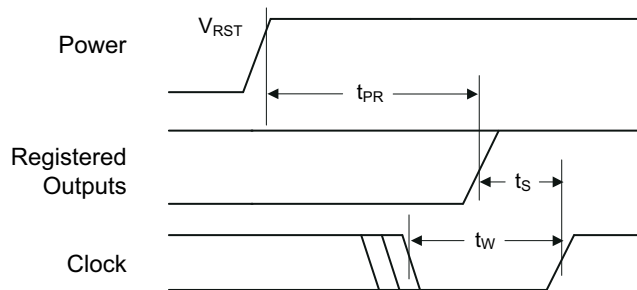
### 3.6 Power-up Reset

Registers of the ATF16V8C are designed to reset during power-up. At a point delayed slightly from  $V_{CC}$  crossing  $V_{RST}$ , all registers will be reset to the low state. As a result, the registered output state will always be high on power-up.

This feature is critical for state machine initialization; however, due to the asynchronous nature of reset and the uncertainty of how  $V_{CC}$  actually rises in the system, the following conditions are required:

1. The  $V_{CC}$  rise must be monotonic, from below 0.7V.
2. After reset occurs, all input and feedback setup times must be met before driving the clock term high.
3. The signals from which the clock is derived must remain stable during  $t_{PR}$ .

**Figure 3-3. Power-up Reset**



**Table 3-4. Power-up Reset Parameters**

Parameter	Description	Typ	Max	Units
$t_{PR}$	Power-up Reset Time	600	1,000	ns
$V_{RST}$	Power-up Reset Voltage	3.8	4.5	V

### 3.7 Power-down Mode

The ATF16V8C includes an optional pin controlled power-down feature. Device Pin 4 can be configured as the power-down pin. When this feature is enabled and the power-down pin is high, total current consumption drops to less than 100 $\mu$ A. In the power-down mode, all output data and internal logic states are latched and held. All registered and combinatorial output data remains valid. Any outputs that were in a high-Z state at the onset of power-down will remain at high-Z. During power-down, all input signals except the power-down pin are blocked. The input and I/O pin-keeper circuits remain active to insure that pins do not float to indeterminate levels. This helps to further reduce system power.

Selection of the power-down option is specified in the ATF16V8C logic design file. The logic compiler will include this option selection in the otherwise standard 16V8 JEDEC fuse file. When the power-down feature is not specified in the design file, Pin 4 is available as a logic input, and there is no power-down pin. This allows the ATF16V8C to be programmed using any existing standard 16V8 fuse file.

Note: Some programmers list the JEDEC-compatible 16V8C (No PD used) separately from the non-JEDEC compatible 16V8CEXT (EXT for extended features).

#### 3.7.1 Power-down AC Characteristics

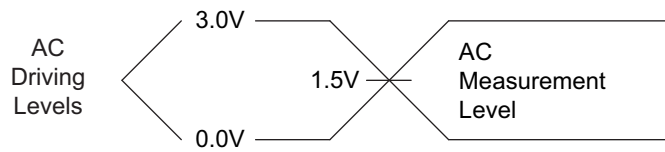
Table 3-5. Power-down AC Characteristics<sup>(1)(2)(3)</sup>

Symbol	Parameter	-5		-7		Units
		Min	Max	Min	Max	
$t_{IVDH}$	Valid Input Before PD High	5.0		7.5		ns
$t_{GVDH}$	Valid $\overline{OE}$ Before PD High	0		0		ns
$t_{CVDH}$	Valid Clock Before PD High	0		0		ns
$t_{DHIX}$	Input Don't Care After PD High		5.0		7.5	ns
$t_{DHGX}$	$\overline{OE}$ Don't Care After PD High		5.0		7.5	ns
$t_{DHCX}$	Clock Don't Care After PD High		5.0		7.5	ns
$t_{DLIV}$	PD Low to Valid Input		5.0		7.5	ns
$t_{DLGV}$	PD Low to Valid $\overline{OE}$		15.0		20.0	ns
$t_{DLCV}$	PD Low to Valid Clock		15.0		20.0	ns
$t_{DLOV}$	PD Low to Valid Output		20.0		25.0	ns

- Notes:
1. Output data is latched and held.
  2. HI-Z outputs remain HI-Z.
  3. Clock and input transitions are ignored.

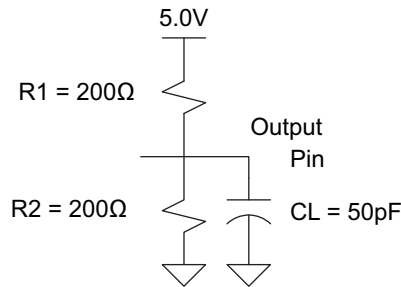


### 3.8 Input Test Waveforms and Measurement Levels



Note:  $t_R, t_F < 1.5\text{ns}$  (10% to 90%)

### 3.9 Output Test Loads



## 4. Registered Output Preload

Registers of the ATF16V8C are provided with circuitry to allow loading of each register with either a high or a low. This feature will simplify testing since any state can be forced into the registers to control test sequencing. A JEDEC file with preload is generated when a source file with vectors is compiled. Once downloaded, the JEDEC file preload sequence will be done automatically by approved programmers.

## 5. Security Fuse Usage

A single fuse is provided to prevent unauthorized copying of the ATF16V8C fuse patterns. Once programmed, fuse verify and preload are inhibited; however, the 64-bit user signature remains accessible.

The security fuse will be programmed last, as its effect is immediate.

## 6. Input and I/O Pin-keeper Circuits

The ATF16V8C contains internal input and I/O pin-keeper circuits. These circuits allow each ATF16V8C pin to hold its previous value even when it is not being driven by an external source or by the device's output buffer. This helps insure that all logic array inputs are at known, valid logic levels. This reduces system power by preventing pins from floating to indeterminate levels. By using pin-keeper circuits rather than pull-up resistors, there is no DC current required to hold the pins in either logic state (high or low).

These pin-keeper circuits are implemented as weak feedback inverters, as shown in the Input Diagram below. These keeper circuits can easily be over driven by standard TTL- or CMOS-compatible drivers. The typical overdrive current required is 40 $\mu$ A.

Figure 6-1. Input Diagram

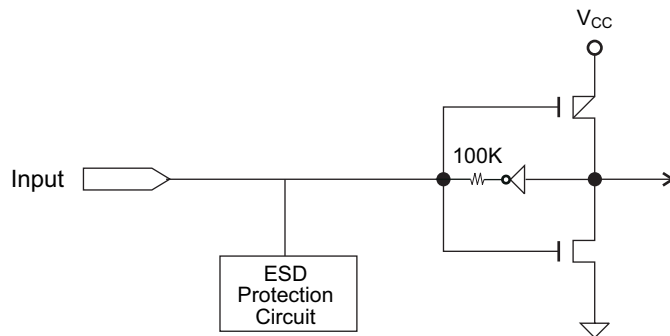
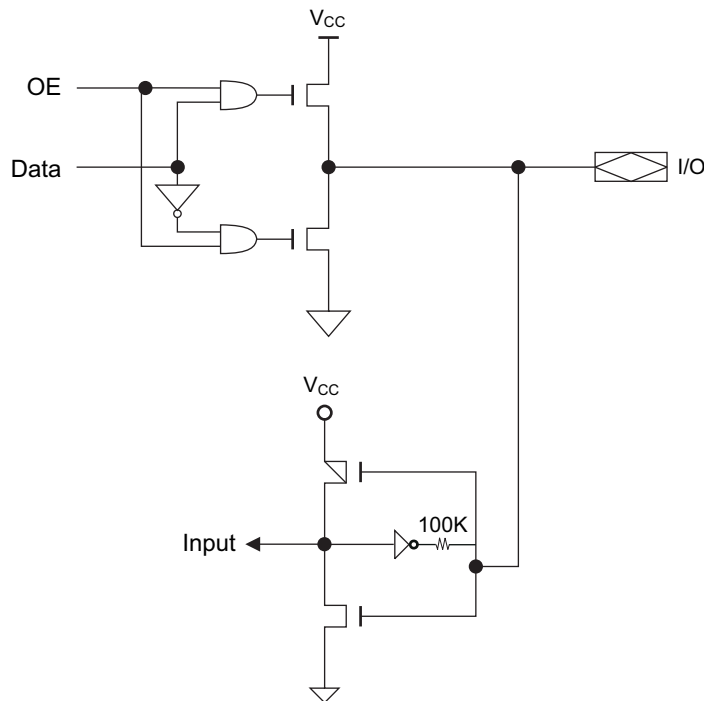


Figure 6-2. I/O Diagram



## 7. Functional Logic Diagram Description

The logic option and functional diagrams describe the ATF16V8C architecture. Eight configurable macrocells can be configured as a registered output, combinatorial I/O, combinatorial output, or dedicated input.

The ATF16V8C can be configured in one of three different modes. Each mode makes the ATF16V8C look like a different device. Most PLD compilers can choose the right mode automatically. The user can also force the selection by supplying the compiler with a mode selection. The determining factors would be the usage of register versus combinatorial outputs and dedicated outputs versus outputs with output enable control.

The ATF16V8C universal architecture can be programmed to emulate many 20-pin PAL devices. These architectural subsets can be found in each of the configuration modes described in the following pages. The user can download the listed subset device JEDEC programming file to the PLD programmer, and the ATF16V8C can be configured to act like the chosen device. Check with your programmer manufacturer for this capability.

Unused product terms are automatically disabled by the compiler to decrease power consumption. A security fuse, when programmed, protects the content of the ATF16V8C. Eight bytes (64 fuses) of user signature are accessible to the user for purposes such as storing project name, part number, revision, or date. The user signature is accessible regardless of the state of the security fuse.

**Table 7-1. Compiler Mode Selection**

	Registered	Complex	Simple	Auto select
CUPL, Atmel-CUPL	G16V8MS	G16V8MA	G16V8AS	G16V8A
With PD ENABLE	G16V8CPMS	G16V8CPMA	G16V8CPAS	G16V8CP

## 8. Macrocell Configuration

Software compilers support the three different OMC modes as different device types. These device types are listed in the table below. Most compilers have the ability to automatically select the device type, generally based on the register usage and output enable ( $\overline{OE}$ ) usage. Register usage on the device forces the software to choose the registered mode. All combinatorial outputs with  $\overline{OE}$  controlled by the product term will force the software to choose the complex mode. The software will choose the simple mode only when all outputs are dedicated combinatorial without  $\overline{OE}$  control. The different device types listed in the table can be used to override the automatic device selection by the software. For further details, refer to the compiler software manuals.

When using compiler software to configure the device, the user must pay special attention to the following restrictions in each mode.

In **Registered mode**, Pin 1 and Pin 11 are permanently configured as clock and output enable, respectively. These pins cannot be configured as dedicated inputs in the registered mode.

In **Complex mode**, Pin 1 and Pin 11 become dedicated inputs and use the feedback paths of Pin 19 and Pin 12 respectively. Because of this feedback path usage, Pin 19 and Pin 12 do not have the feedback option in this mode.

In **simple mode**, all feedback paths of the output pins are routed via the adjacent pins. In doing so, the two inner most pins (pins 15 and 16) will not have the feedback option as these pins are always configured as dedicated combinatorial output.

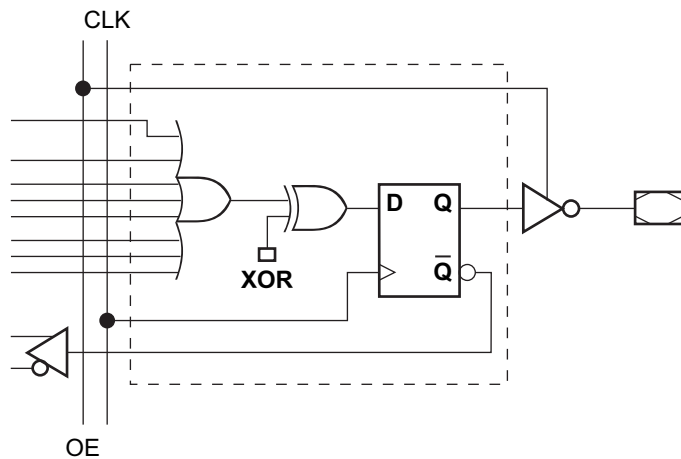
### 8.1 ATF16V8C Registered Mode

**PAL device emulation/PAL replacement.** The registered mode is used if one or more registers are required. Each macrocell can be configured as either a registered or combinatorial output or I/O, or as an input. For a registered output or I/O, the output is enabled by the  $\overline{OE}$  pin, and the register is clocked by the CLK pin. Eight product terms are allocated to the sum term. For a combinatorial output or I/O, the output enable is controlled by a product term, and seven product terms are allocated to the sum term. When the macrocell is configured as an input, the output enable is permanently disabled.

Any register usage will make the compiler select this mode. The following registered devices can be emulated using this mode:

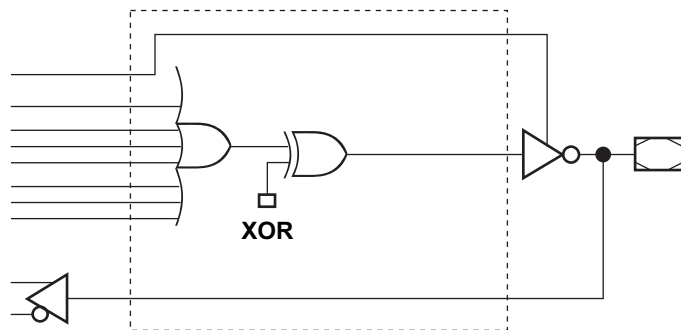
- 16R8
- 16R6
- 16R4
- 16RP8
- 16RP6
- 16RP4

**Figure 8-1. Registered Configuration for Registered Mode<sup>(1)(2)</sup>**



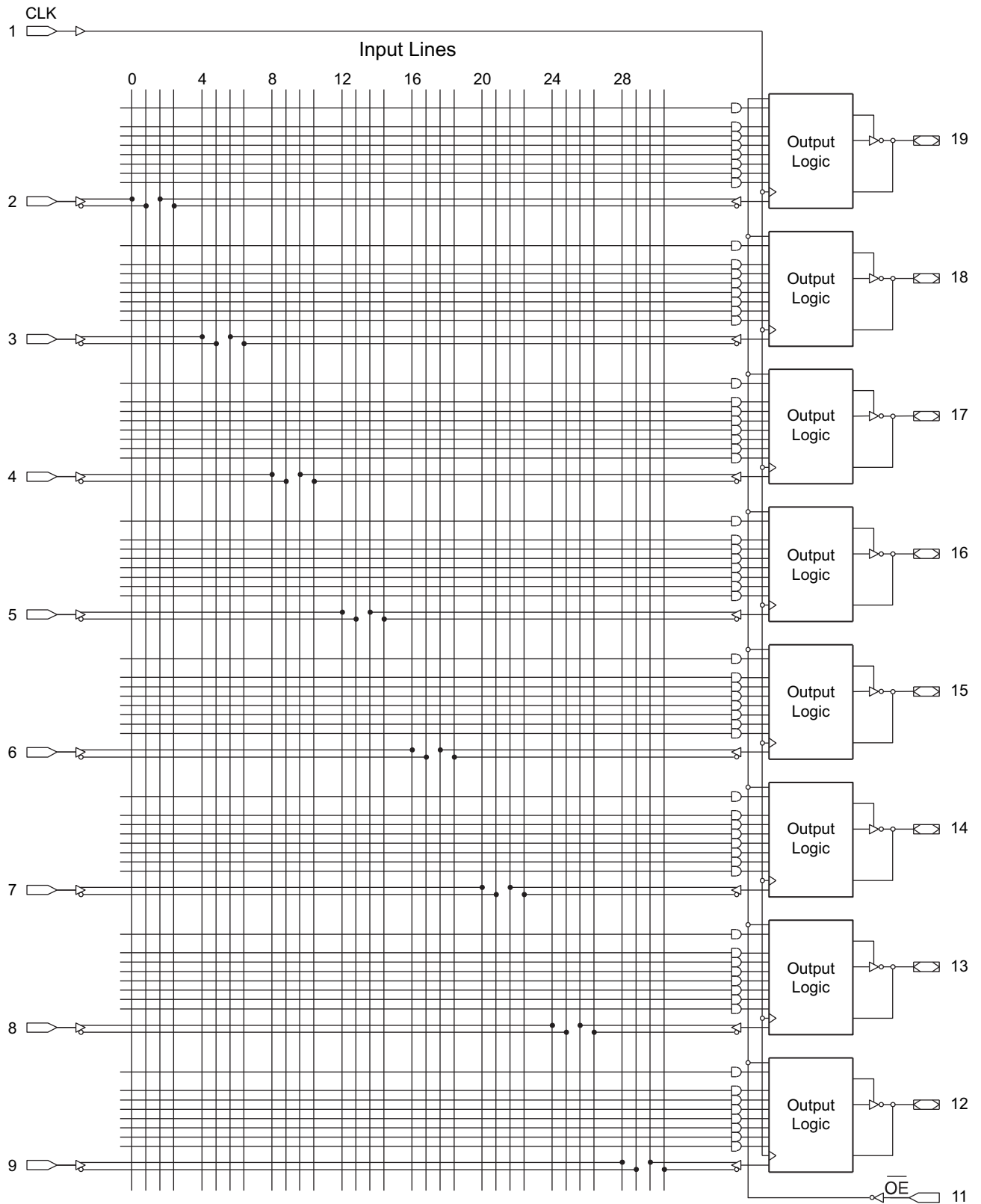
- Notes:
1. Pin 1 controls common CLK for the registered outputs.  
Pin 11 controls common  $\overline{OE}$  for the registered outputs.  
Pin 1 and Pin 11 are permanently configured as CLK and  $\overline{OE}$ .
  2. The development software configures all the architecture control bits and checks for proper pin usage automatically.

**Figure 8-2. Combinatorial Configuration for Registered Mode<sup>(1)(2)</sup>**



- Notes:
1. Pin 1 and Pin 11 are permanently configured as CLK and  $\overline{OE}$ .
  2. The development software configures all the architecture control bits and checks for proper pin usage automatically.

**Figure 8-3. Registered Mode Logic Diagram**



Note: 1. Input not available if power-down mode is enabled.

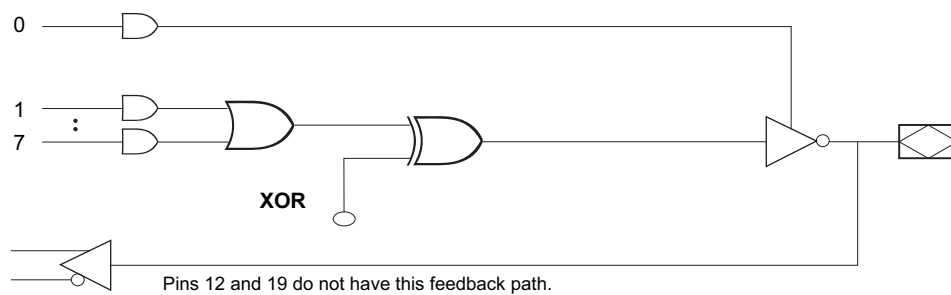
## 9. ATF16V8C Complex Mode

**PAL device emulation/PAL replacement.** In the complex mode, combinatorial output and I/O functions are possible. Pins 1 and 11 are regular inputs to the array. Pins 13 through 18 have pin feedback paths back to the AND-array, which makes full I/O capability possible. Pins 12 and 19 (outermost macrocells) are outputs only. They do not have input capability. In this mode, each macrocell has seven product terms going to the sum term and one product term enabling the output.

Combinatorial applications with an  $\overline{OE}$  requirement will make the compiler select this mode. The following devices can be emulated using this mode:

- 16L8
- 16H8
- 16P8

Figure 9-1. Complex Mode Option



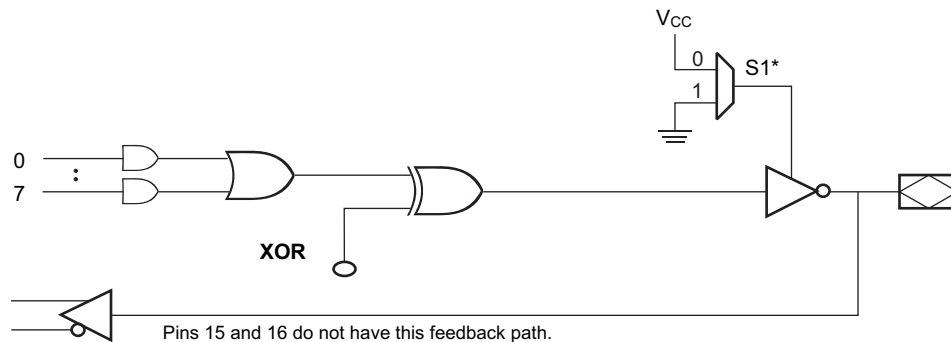
## 10. ATF16V8C Simple Mode

**PAL device emulation/PAL replacement.** In the simple mode, eight product terms are allocated to the sum term. Pins 15 and 16 (center macrocells) are permanently configured as combinatorial outputs. Other macrocells can be either inputs or combinatorial outputs with pin feedback to the AND-array. Pins 1 and 11 are regular inputs.

The compiler selects this mode when all outputs are combinatorial without  $\overline{OE}$  control. The following simple PALs can be emulated using this mode:

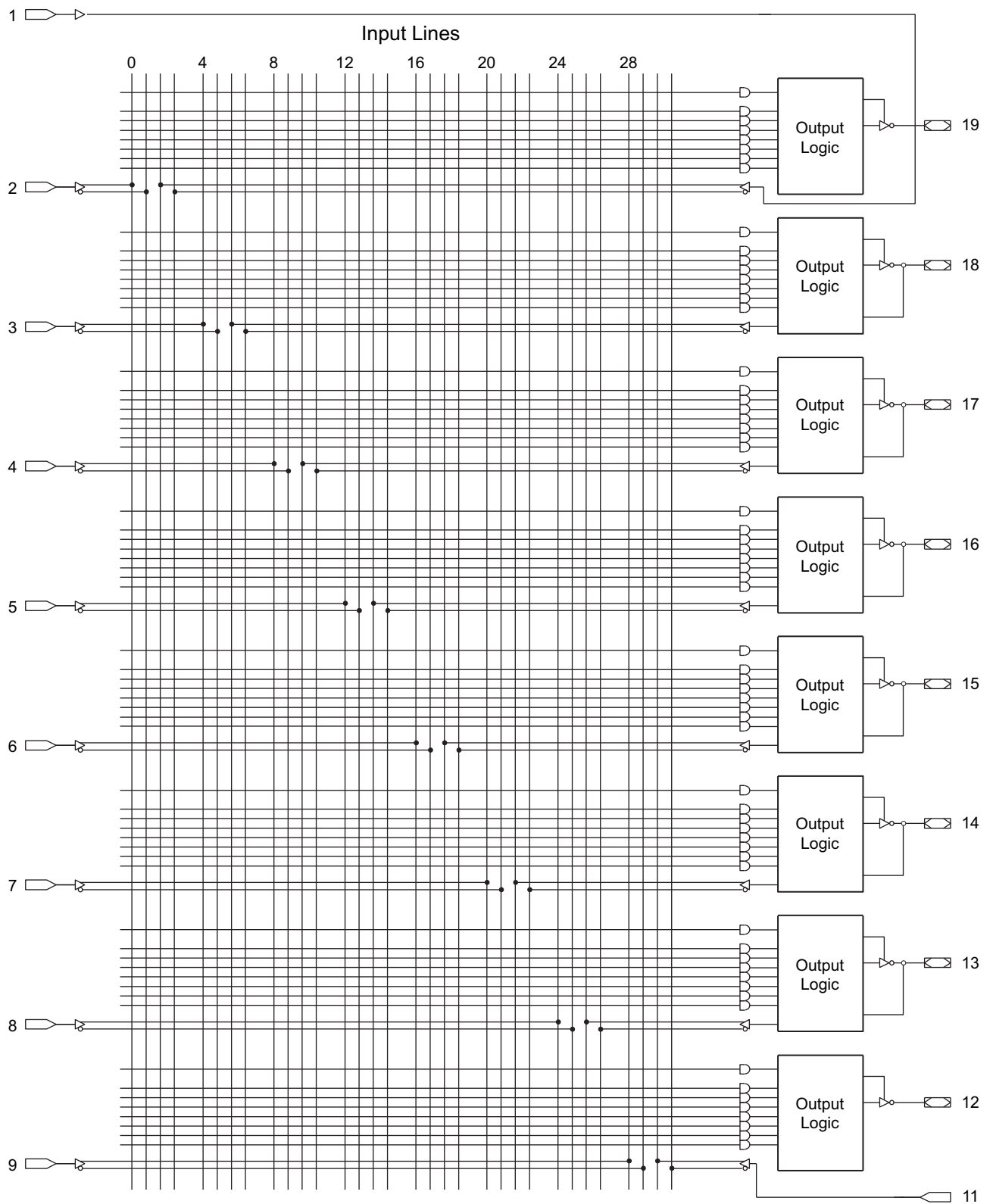
- 10L8 10H8 10P8
- 12L6 12H6 12P6
- 14L4 14H4 14P4
- 16L2 16H2 16P2

Figure 10-1. Simple Mode Option



\* Pins 15 and 16 are always enabled.

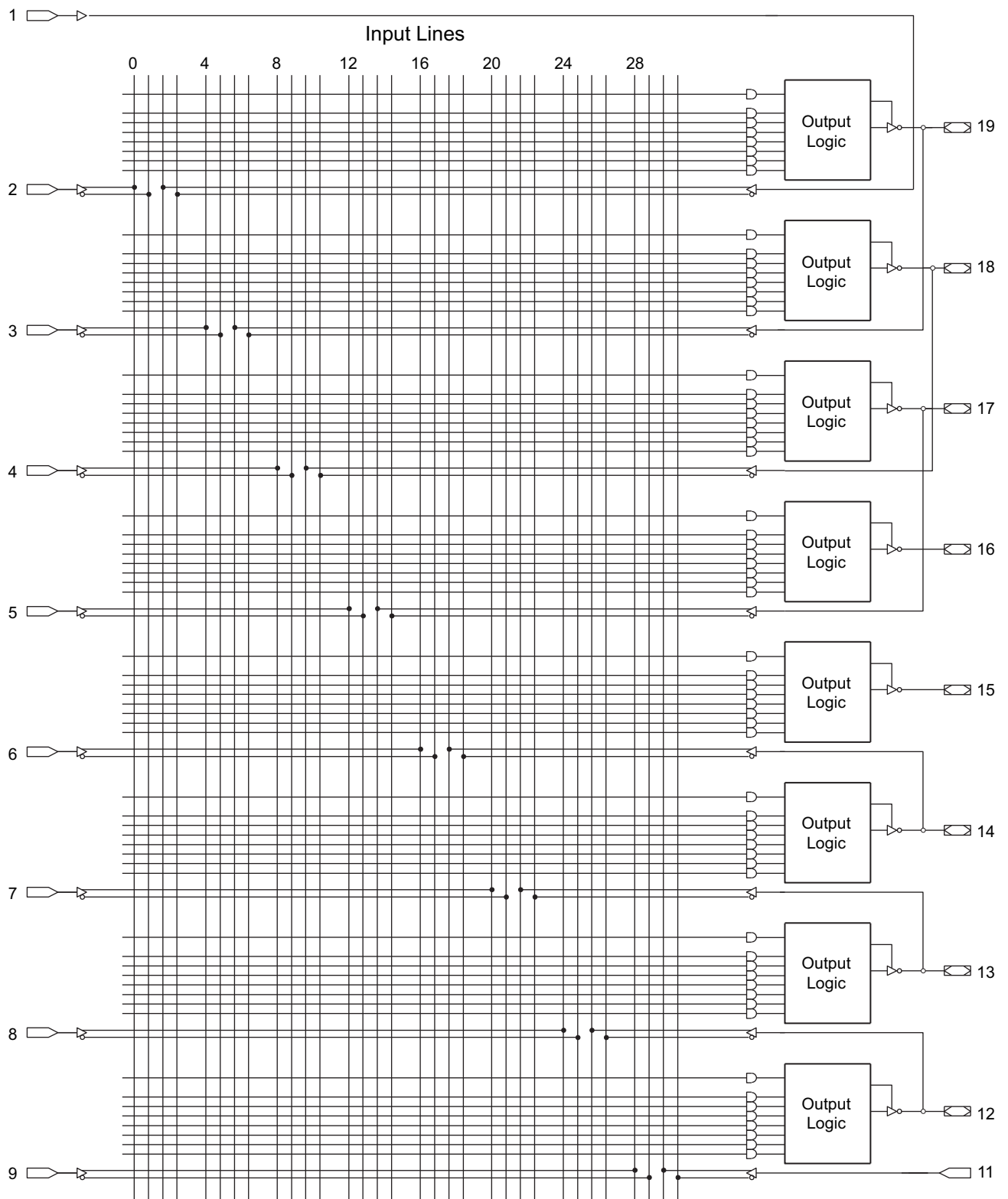
**Figure 10-2. Complex Mode Logic Diagram**



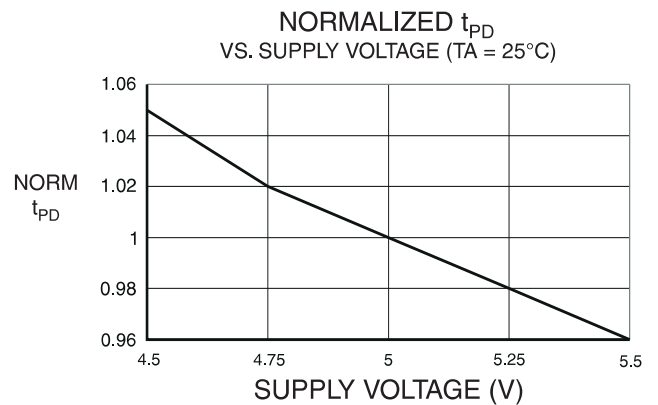
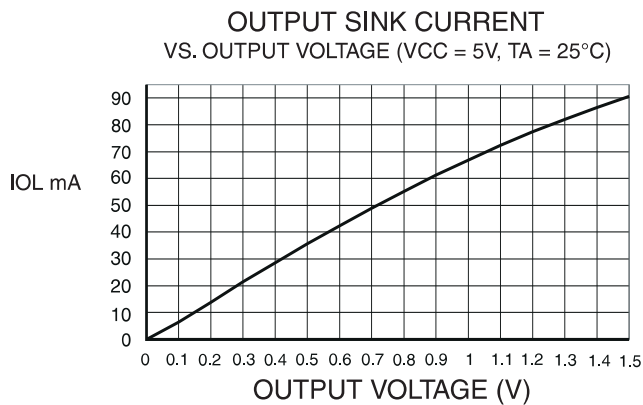
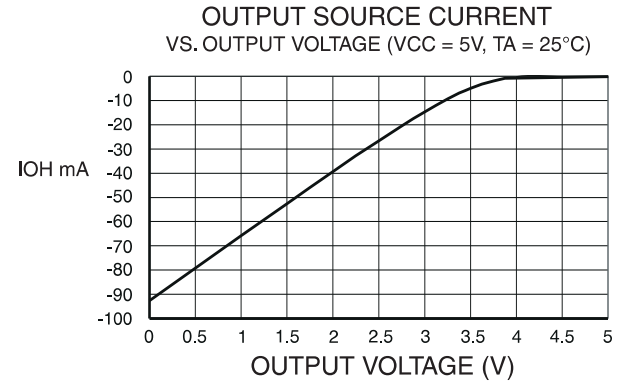
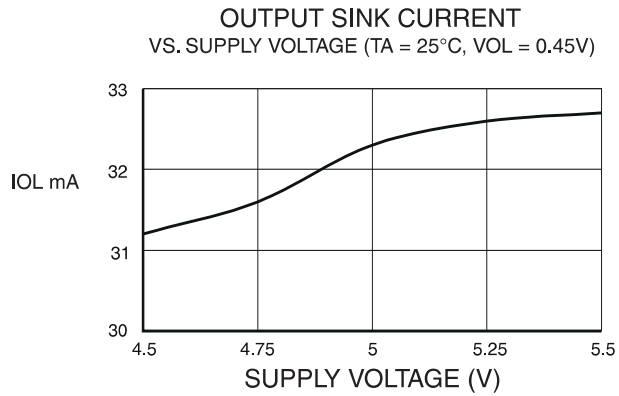
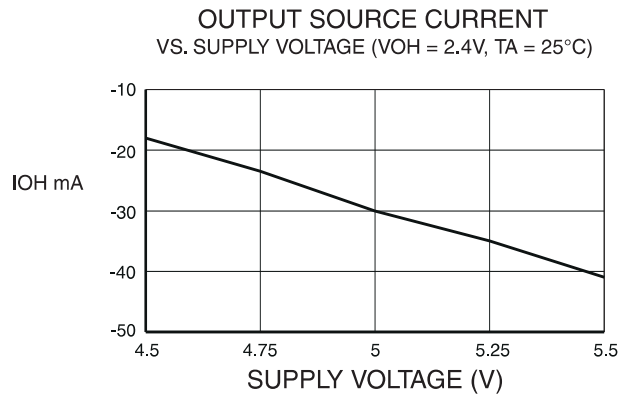
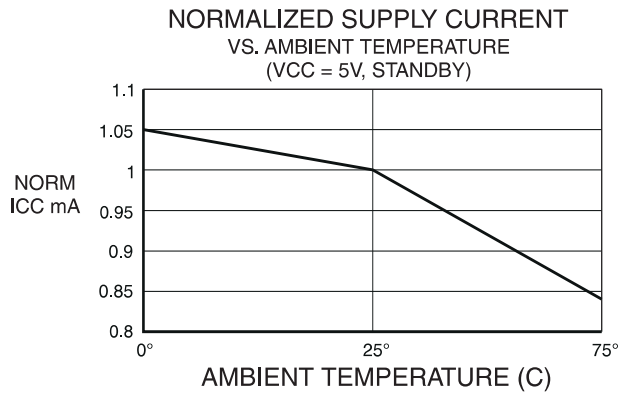
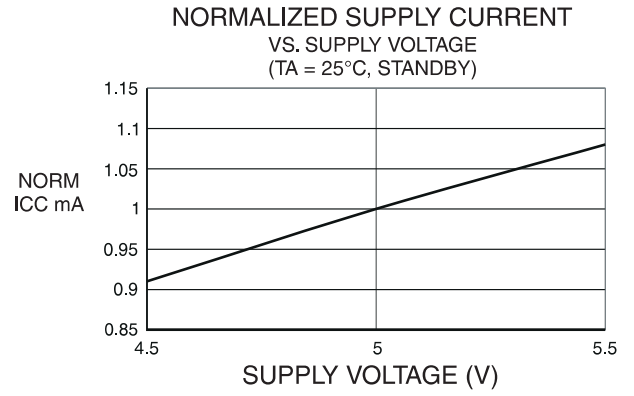
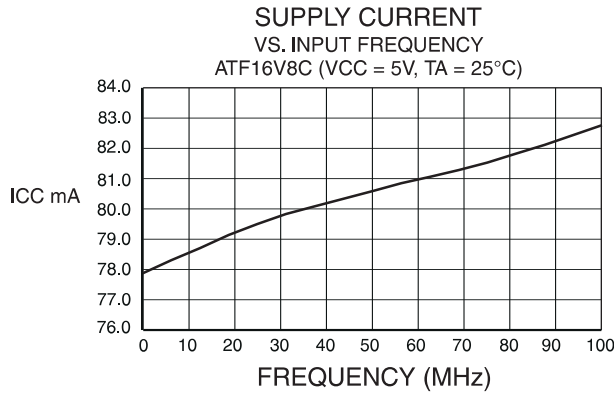
Note: 1. Input not available if power-down mode is enabled.

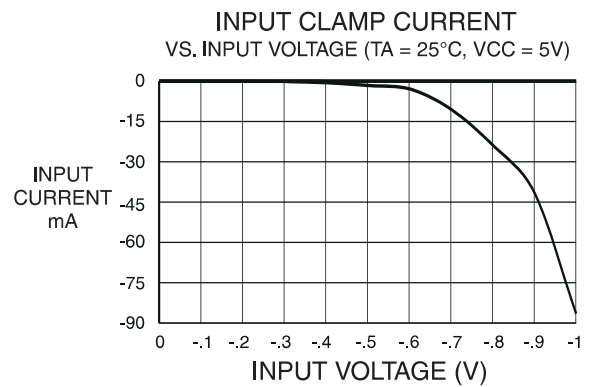
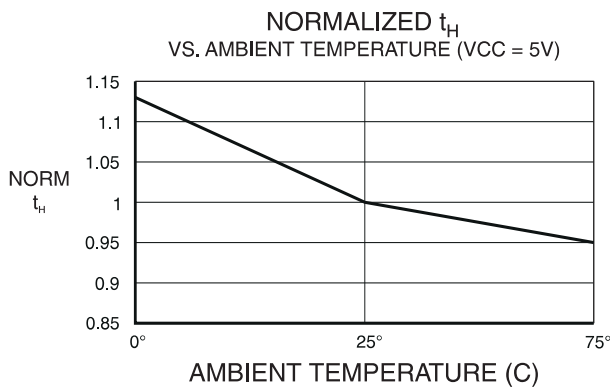
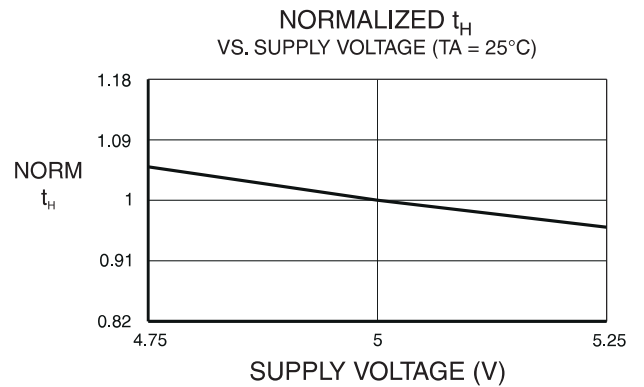
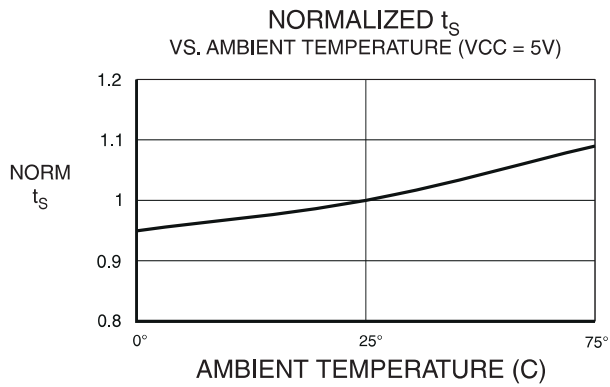
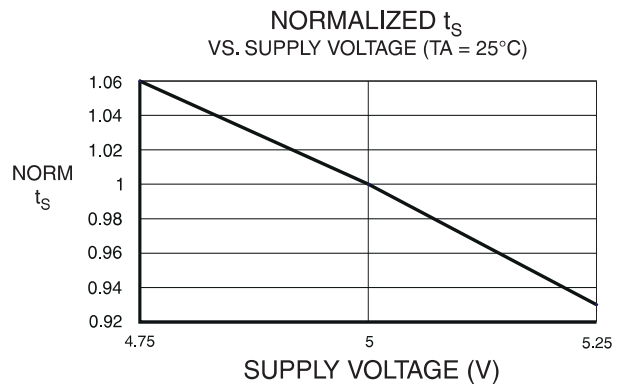
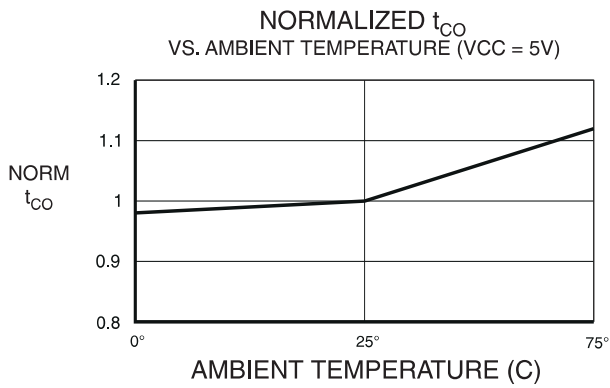
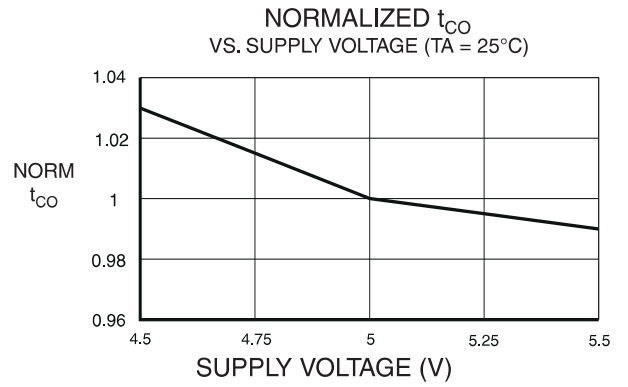
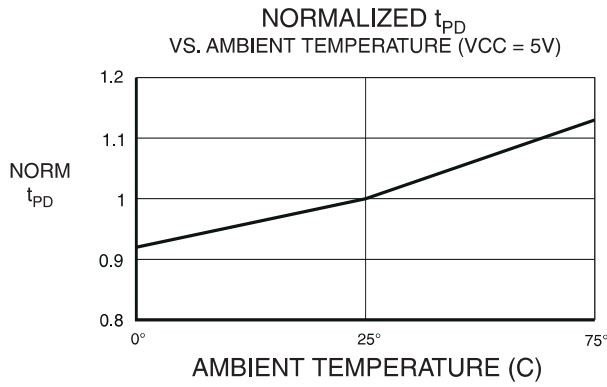


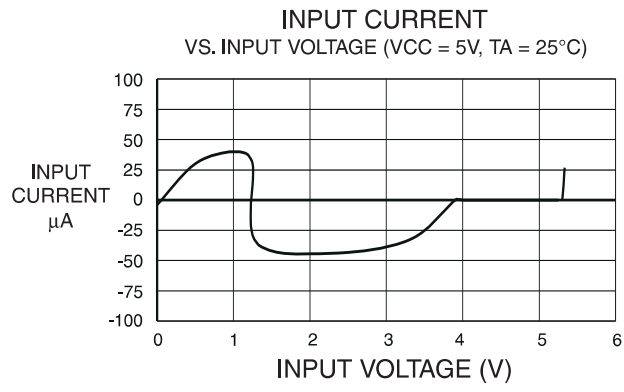
**Figure 10-3. Simple Mode Logic Diagram**



Note: 1. Input not available if power-down mode is enabled.







## 11. Ordering Information

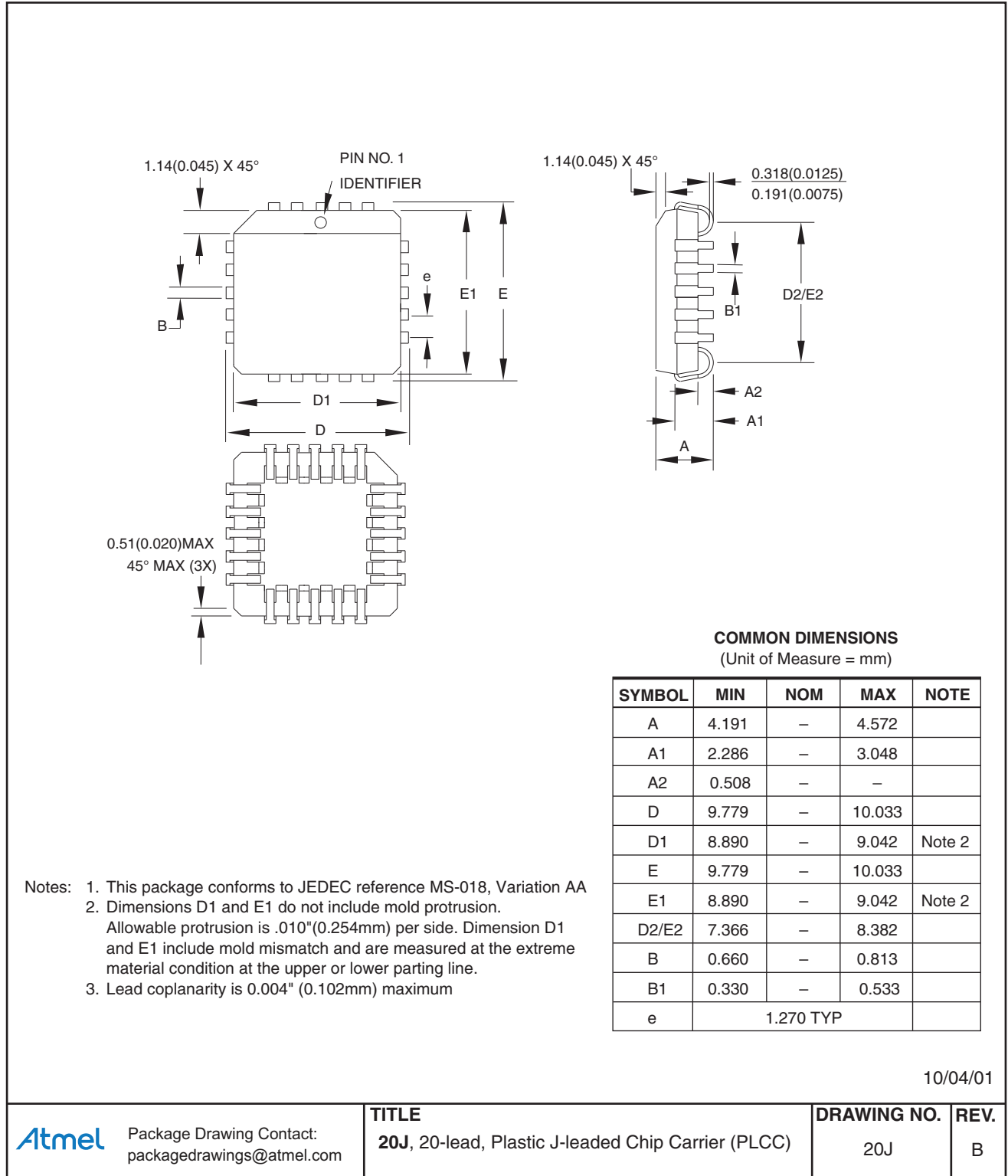
### 11.1 Green Package Options (Pb/Halide-free/RoHS Compliant)

$t_{PD}$ (ns)	$t_S$ (ns)	$t_{CO}$ (ns)	Ordering Code	Package	Operation Range
5	3	4	ATF16V8C-5JX	20J	Commercial (0°C to 70°C)
7.5	5	5	ATF16V8C-7JU	20J	Industrial (-40°C to 85°C)
			ATF16V8C-7PU	20P3	

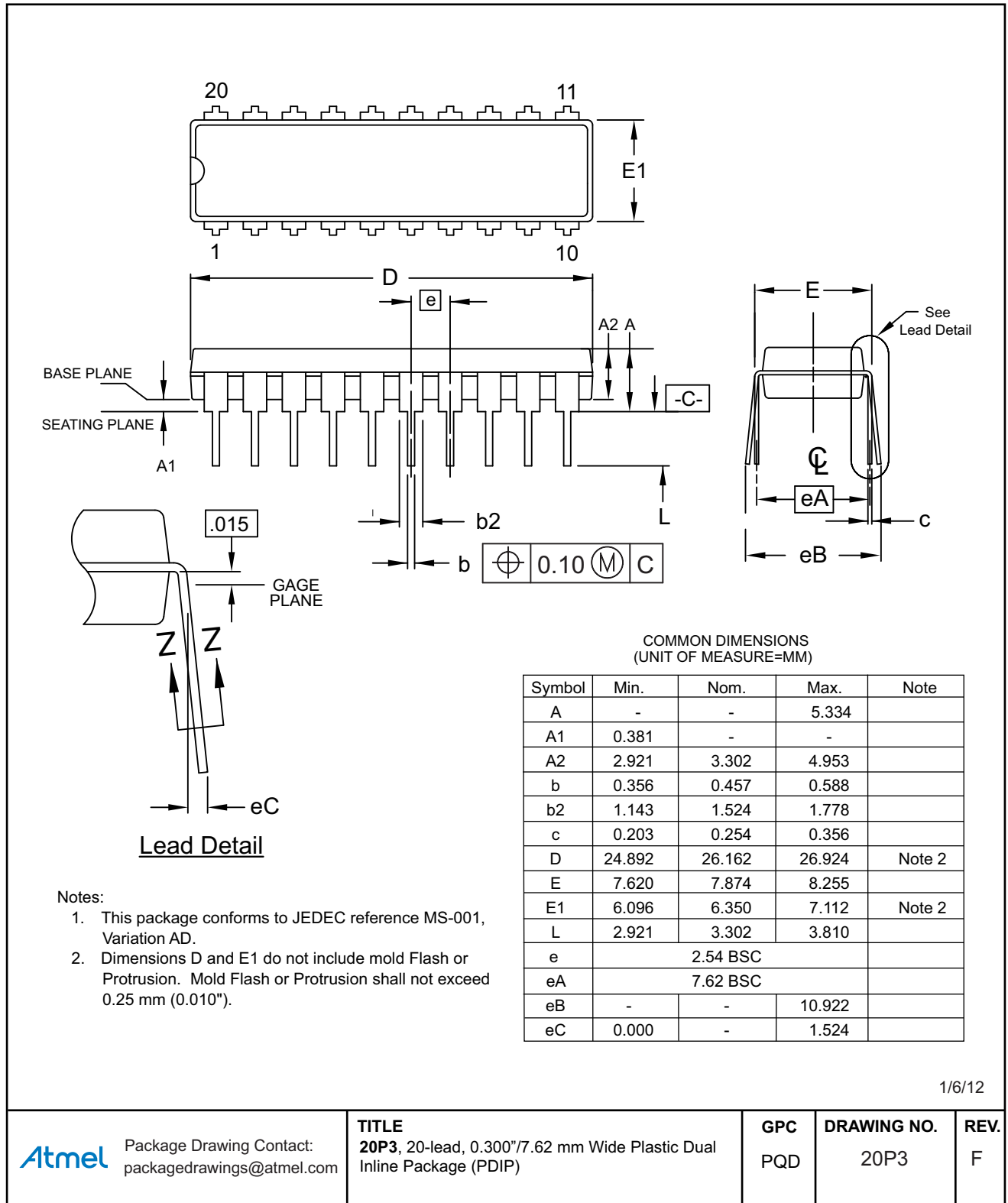
Package type	
20J	20-lead, Plastic J-leaded Chip Carrier (PLCC)
20P3	20-lead, 0.300" Wide, Plastic Dual Inline Package (PDIP)

## 12. Package Drawings

### 12.1 20J — 20-lead PLCC



## 12.2 20P3 — 20-lead PDIP



## 13. Revision History

Doc. Rev.	Date	Comments
0425I	03/2014	Remove "-10JI" and "-7SU" ordering codes and 20S and 20X package drawings. Update package drawings, template, logos, and disclaimer page.
0425H	03/2011	Added green (ROHS compliant) package options. Removed lead based packages from ordering section.





**Atmel Corporation** 1600 Technology Drive, San Jose, CA 95110 USA T: (+1)(408) 441.0311 F: (+1)(408) 436.4200 | [www.atmel.com](http://www.atmel.com)

© 2014 Atmel Corporation. / Rev.: Atmel-0425I-PLD-ATF16V8C-Datasheet\_032014.

Atmel®, Atmel logo and combinations thereof, and others are registered trademarks or trademarks of Atmel Corporation or its subsidiaries. Other terms and product names may be trademarks of others.

DISCLAIMER: The information in this document is provided in connection with Atmel products. No license, express or implied, by estoppel or otherwise, to any intellectual property right is granted by this document or in connection with the sale of Atmel products. EXCEPT AS SET FORTH IN THE ATMEL TERMS AND CONDITIONS OF SALES LOCATED ON THE ATMEL WEBSITE, ATMEL ASSUMES NO LIABILITY WHATSOEVER AND DISCLAIMS ANY EXPRESS, IMPLIED OR STATUTORY WARRANTY RELATING TO ITS PRODUCTS INCLUDING, BUT NOT LIMITED TO, THE IMPLIED WARRANTY OF MERCHANTABILITY, FITNESS FOR A PARTICULAR PURPOSE, OR NON-INFRINGEMENT. IN NO EVENT SHALL ATMEL BE LIABLE FOR ANY DIRECT, INDIRECT, CONSEQUENTIAL, PUNITIVE, SPECIAL OR INCIDENTAL DAMAGES (INCLUDING, WITHOUT LIMITATION, DAMAGES FOR LOSS AND PROFITS, BUSINESS INTERRUPTION, OR LOSS OF INFORMATION) ARISING OUT OF THE USE OR INABILITY TO USE THIS DOCUMENT, EVEN IF ATMEL HAS BEEN ADVISED OF THE POSSIBILITY OF SUCH DAMAGES. Atmel makes no representations or warranties with respect to the accuracy or completeness of the contents of this document and reserves the right to make changes to specifications and products descriptions at any time without notice. Atmel does not make any commitment to update the information contained herein. Unless specifically provided otherwise, Atmel products are not suitable for, and shall not be used in, automotive applications. Atmel products are not intended, authorized, or warranted for use as components in applications intended to support or sustain life.

SAFETY-CRITICAL, MILITARY, AND AUTOMOTIVE APPLICATIONS DISCLAIMER: Atmel products are not designed for and will not be used in connection with any applications where the failure of such products would reasonably be expected to result in significant personal injury or death ("Safety-Critical Applications") without an Atmel officer's specific written consent. Safety-Critical Applications include, without limitation, life support devices and systems, equipment or systems for the operation of nuclear facilities and weapons systems. Atmel products are not designed nor intended for use in military or aerospace applications or environments unless specifically designated by Atmel as military-grade. Atmel products are not designed nor intended for use in automotive applications unless specifically designated by Atmel as automotive-grade.