



Chipsmall Limited consists of a professional team with an average of over 10 year of expertise in the distribution of electronic components. Based in Hongkong, we have already established firm and mutual-benefit business relationships with customers from,Europe,America and south Asia,supplying obsolete and hard-to-find components to meet their specific needs.

With the principle of “Quality Parts,Customers Priority,Honest Operation,and Considerate Service”,our business mainly focus on the distribution of electronic components. Line cards we deal with include Microchip,ALPS,ROHM,Xilinx,Pulse,ON,Everlight and Freescale. Main products comprise IC,Modules,Potentiometer,IC Socket,Relay,Connector.Our parts cover such applications as commercial,industrial, and automotives areas.

We are looking forward to setting up business relationship with you and hope to provide you with the best service and solution. Let us make a better world for our industry!



Contact us

Tel: +86-755-8981 8866 Fax: +86-755-8427 6832

Email & Skype: info@chipsmall.com Web: www.chipsmall.com

Address: A1208, Overseas Decoration Building, #122 Zhenhua RD., Futian, Shenzhen, China



Harness Board Accessories

Panduit harness board accessories allow an installer to quickly configure a specific arrangement of wires, to aid in required wire bundling and termination. Panduit's comprehensive line of harness board accessories can significantly reduce the labor input required for field installation of wires and cables and simplify harness board operations. These products hold wire bundles at a uniform height from a harness board to ease manual or automatic cable tie installation. These accessories help maintain end product consistency, reduce costly rework and maximize workplace safety.



Key Features

Benefits

| | |
|---|---|
| Large selection of board-mounted accessories | Comprehensive and versatile offering ensures there is a product to fit virtually every harness board application |
| A wide range of sizes | Panduit harness board accessories can be used to manage wire configurations up to 2 inches bundle diameter for maximum flexibility |
| Uniform standoff height | Accessories space the wire bundle at a uniform distance and height from the harness board to allow simple cable tie application using manual or automatic tooling to speed installation |
| Mounts designed to work with harness board accessories | Panduit mounts can be integrated into the wiring harness at the harness board to simplify deploying the harness onto the finished assembly to speed installation |
| Snap-in, snap-out functionality | Harness board accessories hold the wires in a tight bundle, yet allow completed harness to be easily removed by lifting upward on the harness |
| Spring wire breakout and wire end holders | Individual wires are held in the bundle to maintain harness structure while allowing consistent termination of wires |

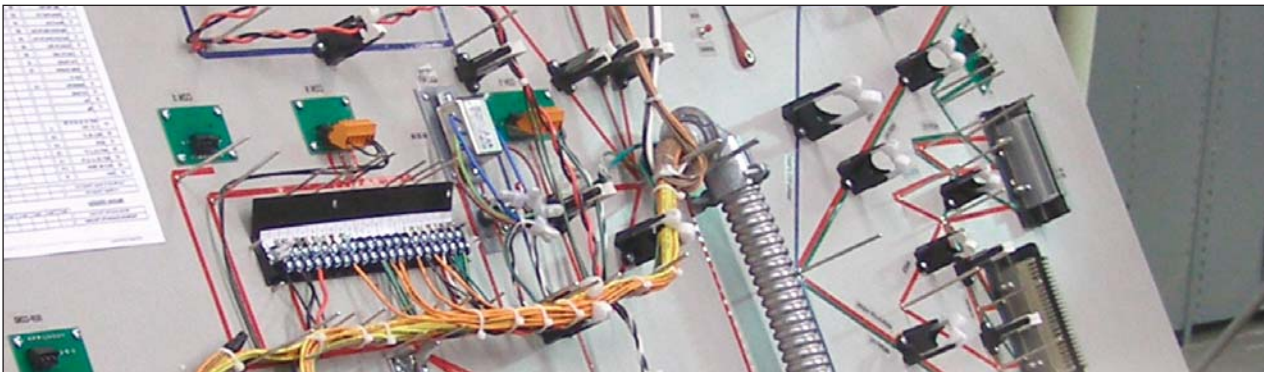

Harness Board Accessories – Wire Retainers

Elastic Retainers

- Cable bundles are formed as individual wires are inserted
- Completed bundles can be easily removed
- The elastic band is replaceable

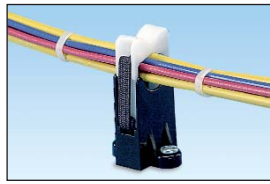

RER.50 – 1.25

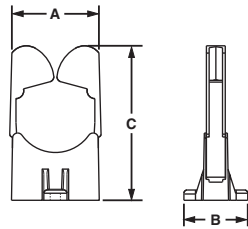

RER2.0

Replacement Elastic

| Part Number | Pkg. Qty. |
|-------------|-----------|
| RER.5E-X | 10 |
| RER.75E-X | 10 |
| RER1.25E-X | 10 |
| RER2.0E-X | 10 |

For economy, the elastic band can be replaced in the RER Elastic Retainers without removing the RER base.

| Part Number | Max. Bundle Diameter | | Length A | | Width B | | Height C | | Material | Color | Mounting Method | Std. Pkg. Qty. | Std. Ctn. Qty. |
|--------------|----------------------|------|----------|------|---------|------|----------|-------|-----------|-----------------------|--------------------|----------------|----------------|
| | In. | mm | In. | mm | In. | mm | In. | mm | | | | | |
| RER.5-S6-X | 0.50 | 12.7 | 1.18 | 30.0 | 0.84 | 21.3 | 1.89 | 48.0 | Nylon 6.6 | Black Base, White Arm | Two #6 (M3) Screws | 10 | 50 |
| RER.75-S6-X | 0.75 | 19.0 | 1.18 | 30.0 | 1.12 | 28.4 | 2.21 | 56.1 | | | | 10 | 50 |
| RER1.25-S6-X | 1.25 | 31.8 | 1.18 | 30.0 | 1.64 | 41.7 | 2.86 | 72.6 | | 10 | | 50 | |
| RER2.0-S6-X | 2.00 | 50.8 | 1.31 | 33.3 | 2.81 | 71.4 | 3.94 | 100.2 | | Natural | | 10 | 50 |

Elastic Retainers – Low Profile

- Cable bundles are formed as cable bundles are inserted
- Completed bundles can be easily removed

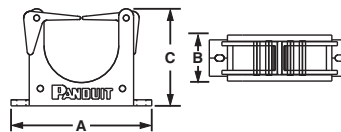
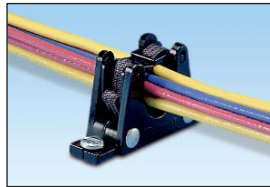

| Part Number | Max. Bundle Diameter | | Length A | | Width B | | Height C | | Material | Color | Mounting Method | Std. Pkg. Qty. | Std. Ctn. Qty. |
|-------------|----------------------|------|----------|------|---------|------|----------|------|-----------|-------|--------------------|----------------|----------------|
| | In. | mm | In. | mm | In. | mm | In. | mm | | | | | |
| ER.5-E4-X | .50 | 12.7 | 1.96 | 49.8 | .56 | 14.2 | 1.00 | 25.4 | Nylon 6.6 | Black | Two #6 (M3) Screws | 10 | 100 |
| ER1.25-E4-X | 1.25 | 31.8 | 2.90 | 73.7 | .95 | 24.1 | 2.00 | 50.8 | | | | 10 | 100 |

Bundle Retainers

- Funnel entry allows fast cable insertion
- Completed bundles can be easily removed
- Color: Black

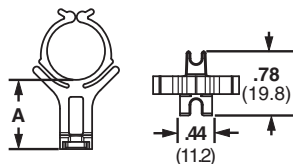

BR.5 and BR.75

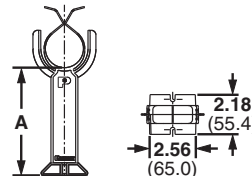

BR2

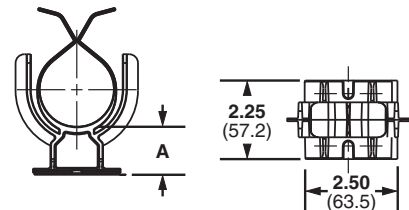

BR2-1.3

| Part Number | Max. Bundle Diameter | | Standoff Height A | | Material | Mounting Method | Std. Pkg. Qty. | Std. Ctn. Qty. |
|-------------|----------------------|------|-------------------|-------|----------------------------|----------------------|----------------|----------------|
| | In. | mm | In. | mm | | | | |
| BR.5-E6-C | 0.50 | 12.7 | 1.07 | 27.2 | Impact Resistant Nylon 6.6 | Two #6 (M3) Screws | 100 | 500 |
| BR.75-E6-C | 0.75 | 19.0 | 0.95 | 24.1 | | 100 | 500 | |
| BR2-1.3-X | 2.00 | 50.8 | 1.32 | 33.5 | Glass Filled Nylon 6.6 | Two 1/4" (M6) Screws | 10 | 10 |
| BR2-1.3-A-X | 2.00 | 50.8 | 1.35 | 34.3 | | Rubber Adhesive Tape | 10 | 10 |
| BR2-1.5-X | 2.00 | 50.8 | 1.59 | 40.4 | | 10 | 10 | |
| BR2-4-X | 2.00 | 50.8 | 4.06 | 103.1 | | Two 1/4" (M6) Screws | 10 | 10 |
| BR2-6-X | 2.00 | 50.8 | 6.02 | 152.9 | | 10 | 10 | |

Corner Posts

- Designed to pre-form tight bundles at harness corners and breakouts

- Top arm rotates upward for easy removal of completed harness

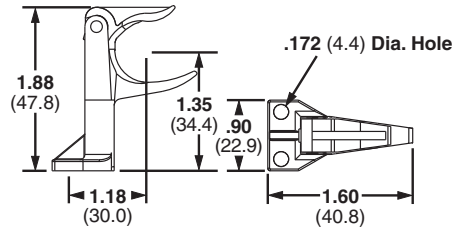

CPH

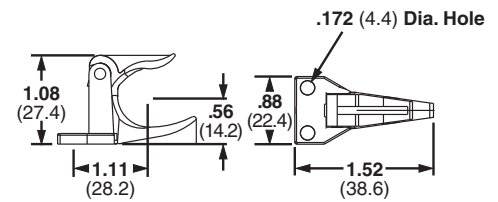

CPL

| Part Number | Max. Bundle Diameter | | Material | Color | Mounting Method | Std. Pkg. Qty. | Std. Ctn. Qty. |
|-------------|----------------------|------|-----------|-------|--------------------|----------------|----------------|
| | In. | mm | | | | | |
| CPH.75-S8-X | .75 | 19.0 | Nylon 6.6 | Black | Two #8 (M4) Screws | 10 | 100 |
| CPL.75-S8-X | | | | | | | |

T-Junction Fixture

- Forms cable junctions

- Fixture moves down for easy harness removal

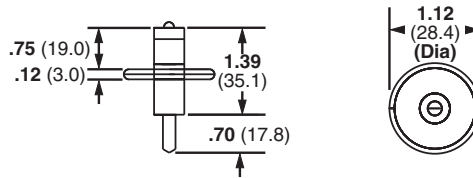

| Part Number | Max. Bundle Diameter | | Material | Color | Mounting Method | Std. Pkg. Qty. | Std. Ctn. Qty. |
|-------------|----------------------|------|-----------------------------------|-------|-----------------|----------------|----------------|
| | In. | mm | | | | | |
| TJF-X | 1.34 | 34.0 | Nylon 6.6 and Nickel Plated Steel | Black | Nail | 10 | 100 |

Harness Board Nails

- Speed routing of wires
- Uniform driving depth is insured by a collar stop

- Smooth finish on nails prevents abrasion to wire jackets

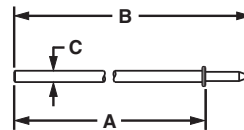

| Part Number | Length A | | Overall Length B | | Thickness C | | Material | Mounting Method | Std. Pkg. Qty. | Std. Ctn. Qty. |
|-------------|----------|-------|------------------|--------|-------------|-----|---------------------|-----------------------------|----------------|----------------|
| | In. | mm | In. | mm | In. | mm | | | | |
| HBN.75-T | .75 | 19.1 | 1.40 | 35.56 | .07 | 1.9 | Nickel Plated Steel | Hammered into harness board | 200 | 1000 |
| HBN1-T | 1.00 | 25.4 | 1.65 | 41.91 | .07 | 1.9 | | | 200 | 1000 |
| HBN1.5-T | 1.50 | 38.1 | 2.16 | 54.86 | .08 | 2.1 | | | 200 | 1000 |
| HBN2-T | 2.00 | 50.8 | 2.66 | 67.56 | .09 | 2.4 | | | 200 | 1000 |
| HBN2.5-T | 2.50 | 63.5 | 3.16 | 80.26 | .11 | 2.8 | | | 200 | 1000 |
| HBN3-T | 3.00 | 76.2 | 3.67 | 93.22 | .12 | 3.0 | | | 200 | 1000 |
| HBN4-T | 4.00 | 101.6 | 4.67 | 118.62 | .14 | 3.7 | | | 200 | 1000 |

Harness Board Accessories – Wire Termination

Wire End Holder

- Secures wire ends while harness is being fabricated
- Used with #28 thru #16 AWG wires
- For indoor use only

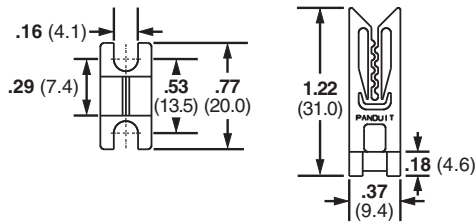

| Part Number | Material | Color | Mounting Method | Std. Pkg. Qty. | Std. Ctn. Qty. |
|-------------|----------|-------|--------------------|----------------|----------------|
| WEH-E8-C | Acetal | Black | Two #8 (M4) Screws | 100 | 1000 |

Spring Wire Breakout System

- Harness board spring and spring holder holds wire ends secure while harness is being fabricated
- Wires simply pull out from spring when harness is removed
- Each SHH Spring Holder is supplied with one rigid wire piece to hold the spring laterally and two #8 (M4), 2 inch (50.8mm) hex head wood screws; purchase spring separately

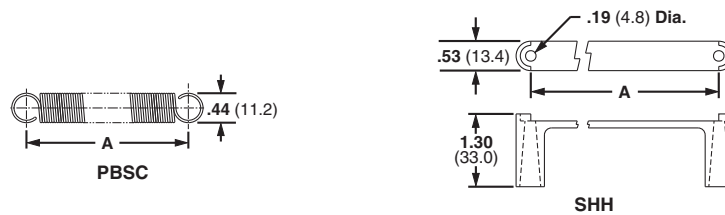

| Part Number | Hole Spacing A | | Material | Color | Mounting Method | Std. Pkg. Qty. | Std. Ctn. Qty. |
|-------------|----------------|-------|-----------|---------|--------------------|----------------|----------------|
| | In. | mm | | | | | |
| PBSC1-X | 1.00 | 25.4 | Steel | — | SHH1 Spring Holder | 10 | 100 |
| PBSC3-X | 3.00 | 76.2 | | — | Two #8 (M4) Screws | 10 | 100 |
| PBSC6-X | 6.00 | 152.4 | | — | SHH3 Spring Holder | 10 | 100 |
| PBSC12-X | 12.00 | 304.8 | | — | Two #8 (M4) Screws | 10 | 100 |
| SHH1-S8-X | 1.85 | 47.0 | Nylon 6.6 | Natural | Two #8 (M4) Screws | 10 | 100 |
| SHH3-S8-X | 6.80 | 172.7 | | | Two #8 (M4) Screws | 10 | 100 |

Fanning Strip System

- Holds wires in a specific orientation
- No sharp edges to damage wire insulation
- Will accept wires up to 18 AWG
- Fanning strip can remain as part of completed harness

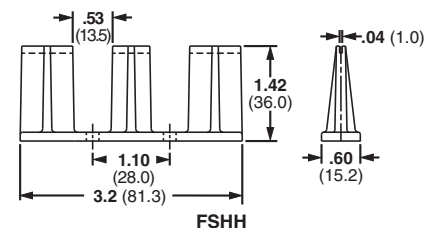
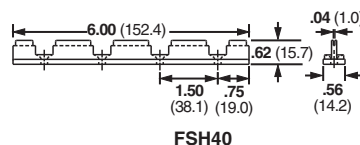
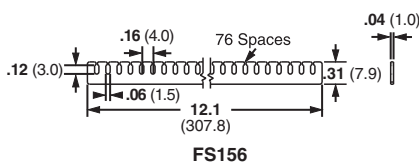

| Part Number | Material | Color | Mounting Method | Std. Pkg. Qty. | Std. Ctn. Qty. |
|-------------|-----------|---------|---------------------|----------------|----------------|
| FS156-C | Nylon 6.6 | Natural | FSH Holder | 100 | 1000 |
| FSH40-X | ABS | Black | Four #8 (M4) Screws | 10 | 100 |
| FSHH-X | | | Two #8 (M4) Screws | 10 | 100 |

Harness Board Standoff Posts and Adapter

- Used to hold a push mount accessory or cable tie at a specific location on a harness board

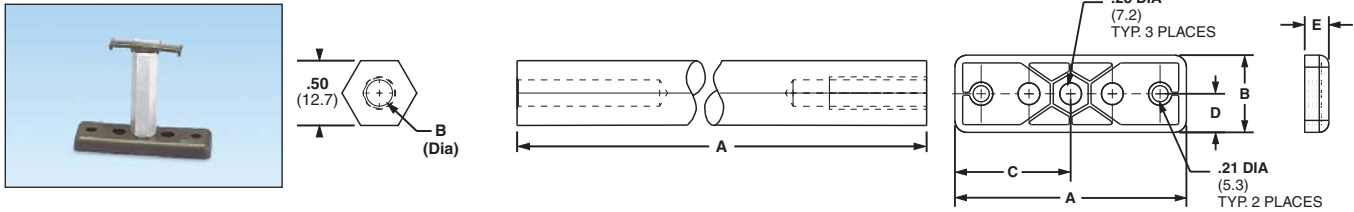

| Part Number | Height A | | Hole Diameter B | | Length C | | Width D | | For Use With | Material | Mounting Method | Std. Pkg. Qty. | Std. Ctn. Qty. |
|-------------|----------|------|-----------------|-----|----------|-------|---------|------|-----------------------------------|-----------|-----------------|----------------|----------------|
| | In. | mm | In. | mm | In. | m | In. | mm | | | | | |
| HB2SP19-X | 2.00 | 50.8 | .20 | 5.2 | 2.00 | 50.8 | .50 | 12.7 | PLWP, PRWP, WS, VWS, HWS, TPM | Aluminum | M6 Screw | 10 | 100 |
| HB2SP25-X | 2.00 | 50.8 | .30 | 7.5 | 4.00 | 101.6 | .50 | 12.7 | PLWP, PRWP, PLP, THMS, HCMP, PMCC | Aluminum | M6 Screw | 10 | 100 |
| HBUA-X | .31 | 7.9 | .28 | 7.1 | 3.00 | 76.2 | 1.00 | 25.4 | HB2SP19-X, HB2SP25-X | Nylon 6.6 | #10 (M5) Screw | 10 | 100 |

Tie Harness Mounts – Nylon and Heat Stabilized Nylon 6.6

- Designed to be attached to the wire harness during assembly
- Cable ties can be installed by hand or with Panduit automatic cable tie tools
- Used with harness board standoff posts
- Available with or without corrugated tubing location tab
- Natural nylon material for indoor use
- Heat stabilized nylon material (30) for high temperature applications – indoor use

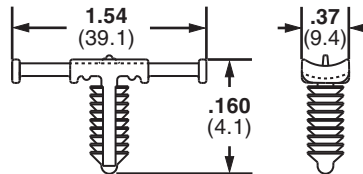

| Part Number | Used with Cable Ties* | Maximum Panel Thickness | | Panel Hole Diameter | | Material | Color | Mounting Method | Std. Pkg. Qty. | Std. Ctn. Qty. |
|-------------|-----------------------|-------------------------|----|---------------------|----|----------|-------|-----------------|----------------|----------------|
| | | In. | mm | In. | mm | | | | | |

FOR CORRUGATED TUBING – A location tab on the mount shelf aligns with the corrugated tubing grooves to ensure proper mount location during assembly

| | | | | | | | | | | |
|-------------|---------|------|-----|-------------|-----------|---------------------------|---------|-----------|-----|------|
| THMSP20-C | M, I, S | .160 | 4.1 | .244 – .283 | 6.2 – 7.2 | Nylon 6.6 | Natural | Push barb | 100 | 1000 |
| THMSP20-C30 | M, I, S | .160 | 4.1 | .244 – .283 | 6.2 – 7.2 | Heat Stabilized Nylon 6.6 | Black | Push barb | 100 | 1000 |
| THMSP25-C | M, I, S | .230 | 5.8 | .244 – .283 | 6.2 – 7.2 | Nylon 6.6 | Natural | Push barb | 100 | 1000 |
| THMSP25-C30 | M, I, S | .230 | 5.8 | .244 – .283 | 6.2 – 7.2 | Heat Stabilized Nylon 6.6 | Black | Push barb | 100 | 1000 |

FOR DISCRETE WIRING – No location tab

| | | | | | | | | | | |
|--------------|---------|------|-----|-------------|-----------|---------------------------|---------|-----------|-----|------|
| THMSP20F-C | M, I, S | .160 | 4.1 | .244 – .283 | 6.2 – 7.2 | Nylon 6.6 | Natural | Push barb | 100 | 1000 |
| THMSP20F-C30 | M, I, S | .160 | 4.1 | .244 – .283 | 6.2 – 7.2 | Heat Stabilized Nylon 6.6 | Black | Push barb | 100 | 1000 |
| THMSP25F-C | M, I, S | .230 | 5.8 | .244 – .283 | 6.2 – 7.2 | Nylon 6.6 | Natural | Push barb | 100 | 1000 |
| THMSP25F-C30 | M, I, S | .230 | 5.8 | .244 – .283 | 6.2 – 7.2 | Heat Stabilized Nylon 6.6 | Black | Push barb | 100 | 1000 |

*Cable tie cross section sizes: M = Miniature, I = Intermediate, S = Standard.

Automatic Cable Tie Mounts



- Multiple sizes work with industry standard panel thickness and hole diameters for greater application flexibility
- Low profile design keeps bundle close to mounting surface saving space where tight assemblies are required, and providing greater protection for bundles in high vibration applications
- Load rating of mounts supports compatible BT1.5M-XMR and PLT1.5M-XMR cable ties

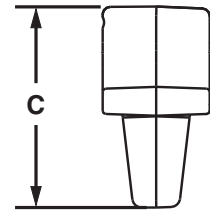
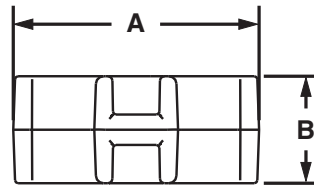

| Part Number | Used with Cable Ties | A Length | | B Width | | C Height | | Maximum Panel Thickness | | Panel Hole Diameter Range | | Material | Color | Std. Pkg. Qty. | Std. Ctn. Qty. | | | | |
|--------------|----------------------------|----------|------|---------|-----|----------|------|-------------------------|-----|---------------------------|-----------|---------------------------|---------|----------------|----------------|---------------------------|---------|------|------|
| | | In. | mm | In. | mm | In. | mm | In. | mm | In. | mm | | | | | | | | |
| ATM-W187-M | BT1.5M-XMR, PLT1.5M-XMR | .80 | 20.5 | .35 | 9.0 | .58 | 14.6 | .12 | 3.0 | .17 – .20 | 4.3 – 4.9 | Nylon 6.6 | Natural | 1000 | 5000 | | | | |
| ATM-W187-M20 | | | | | | | | | | | | | Black | 1000 | 5000 | | | | |
| ATM-W187-M30 | | | | | | | | | | | | Heat Stabilized Nylon 6.6 | Black | 1000 | 5000 | | | | |
| ATM-W250-M | | | | | | | | | | | | .66 | 16.6 | .23 – .26 | 5.7 – 6.6 | Nylon 6.6 | Natural | 1000 | 5000 |
| ATM-W250-M20 | | | | | | | | | | | | | | | | | Black | 1000 | 5000 |
| ATM-W250-M30 | | | | | | | | | | | | | | | | Heat Stabilized Nylon 6.6 | Black | 1000 | 5000 |

Order number of pieces required, in multiples of Standard Package Quantity.

Harness Board Fixtures

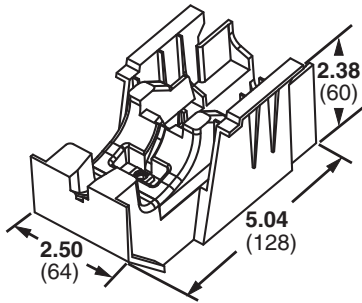

ATMB (Base)

- Automatic alignment orients the tool head with the mount for reliable feeding of the cable tie through the mount to speed installation
- Multiple fixture configurations allow mounting in horizontal, vertical, or 45° orientation to reduce installation time and improve ergonomics
- Color designation ensures inserts and mounts are correctly matched
- Integrated switch* capability enables placement of a switch to detect the mount's presence providing an input to a quality control system, eliminating the need for additional inspection
- Activation device on harness board fixture prevents tool from operating unless it is properly engaged in the fixture for operator safety

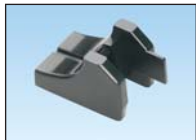

| Part Number | Description | Mounting | Color | Material | Std. Pkg. Qty.* | Std. Ctn. Qty. |
|-------------|--|---|--------|----------|-----------------|----------------|
| ATMB | Base | Screw base to harness board with 1/4" screws | Black | Acetal | 10 | 10 |
| ATMI-W187-X | Insert for ATM-W187 mount | Snaps into ATMB | Yellow | Acetal | 10 | 50 |
| ATMI-W250-X | Insert for ATM-W250 mount | Snaps into ATMB | Red | Acetal | 10 | 50 |
| ATMI-XMR | Used for cable tie installations where mounts are NOT required | Snaps into ATMB | Black | Acetal | 10 | 50 |
| ATMC | Clamp used to secure the ATMB (base) in a vertical or 45° position | Screw clamp to harness board with 1/4" screws | Black | Steel | 10 | 10 |

Order number of pieces required, in multiples of Standard Package Quantity.

*The Omron Electronics D2SW-3L1HS switch is compatible with the ATM system. Similar switches from other manufacturers may also be suitable.

Omron is a registered trademark of Omron Corporation.

Harness Board Accessories – Complementary Products from Panduit

Fully Automatic Cable Tie Installation Systems

A complete single-source solution for high volume harnessing, assembly, fastening, and packaging applications. With cycle times of less than one second, the systems are up to six times faster than conventional manual cable tie installations.



Bundling Systems



Bundling and Mounting System



PAT/Robot Integration Kit

Abrasion Protection Products

Panduit Abrasion protection products provide an economical and easy way to insulate, protect, bundle, and color-code components and cable. A wide variety of sizes and materials are available to meet a broad range of indoor and outdoor applications.



Pan-Wrap™ Split Harness Wrap



Corrugated Loom Tubing



Braided Expandable Sleeving



Spiral Wrap

Terminals, Disconnects, Ferrules and Splices

Connectors are available loose piece for manual installation and continuously molded for high volume automated installation. Panduit's manual and automated installation tooling improve productivity and reliability for industrial settings.



Wide Variety of Terminals, Disconnects, and Splices

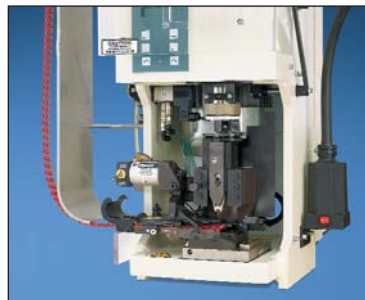

4-Ton Press and Universal Applicator

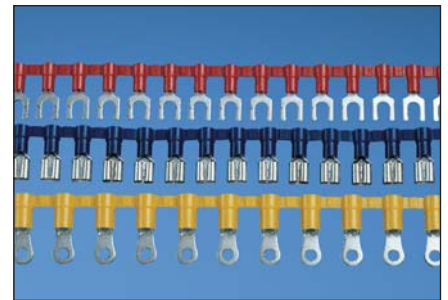

Reel Smart™ Continuously Molded Connectors

Dimensions are in inches (Dimensions in parentheses are metric)

WORLDWIDE SUBSIDIARIES AND SALES OFFICES

PANDUIT CANADA
Markham, Ontario
cs-cdn@panduit.com
Phone: 800.777.3300

PANDUIT EUROPE LTD.
London, UK
cs-emea@panduit.com
Phone: 44.20.8601.7200

PANDUIT SINGAPORE PTE. LTD.
Republic of Singapore
cs-ap@panduit.com
Phone: 65.6305.7575

PANDUIT JAPAN
Tokyo, Japan
cs-japan@panduit.com
Phone: 81.3.6863.6000

PANDUIT LATIN AMERICA
Jalisco, Mexico
cs-la@panduit.com
Phone: 52.33.3777.6000

PANDUIT AUSTRALIA PTY. LTD.
Victoria, Australia
cs-aus@panduit.com
Phone: 61.3.9794.9020

For a copy of Panduit product warranties, log on to www.panduit.com/warranty

For more information

Visit us at www.panduit.com

Contact Customer Service by email: cs@panduit.com
or by phone: 800-777-3300 and reference WACB20

PANDUIT®

©2010 Panduit Corp.
ALL RIGHTS RESERVED.
Printed in the U.S.A.
Product Bulletin Number SA-WACB20
Replaces SA101N556-WA
8/2010