



Chipsmall Limited consists of a professional team with an average of over 10 year of expertise in the distribution of electronic components. Based in Hongkong, we have already established firm and mutual-benefit business relationships with customers from,Europe,America and south Asia,supplying obsolete and hard-to-find components to meet their specific needs.

With the principle of "Quality Parts,Customers Priority,Honest Operation,and Considerate Service",our business mainly focus on the distribution of electronic components. Line cards we deal with include Microchip,ALPS,ROHM,Xilinx,Pulse,ON,Everlight and Freescale. Main products comprise IC,Modules,Potentiometer,IC Socket,Relay,Connector.Our parts cover such applications as commercial,industrial, and automotives areas.

We are looking forward to setting up business relationship with you and hope to provide you with the best service and solution. Let us make a better world for our industry!



## Contact us

Tel: +86-755-8981 8866 Fax: +86-755-8427 6832

Email & Skype: info@chipsmall.com Web: www.chipsmall.com

Address: A1208, Overseas Decoration Building, #122 Zhenhua RD., Futian, Shenzhen, China



# Standard Board Level Heat Sink Catalog

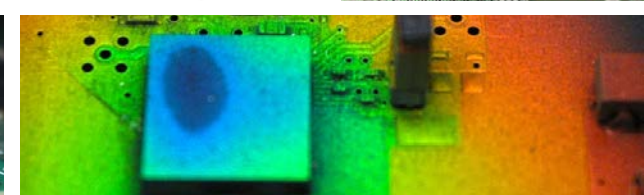
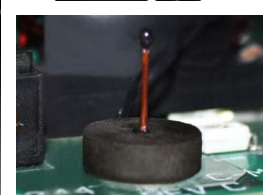
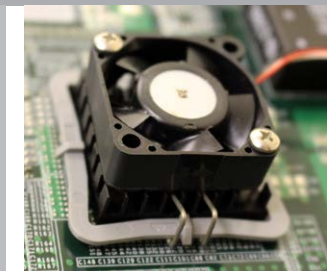
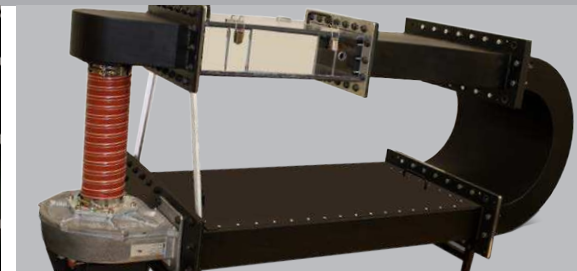
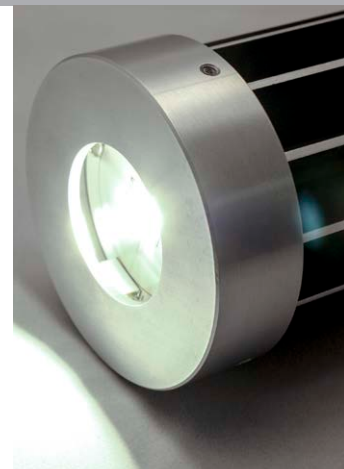
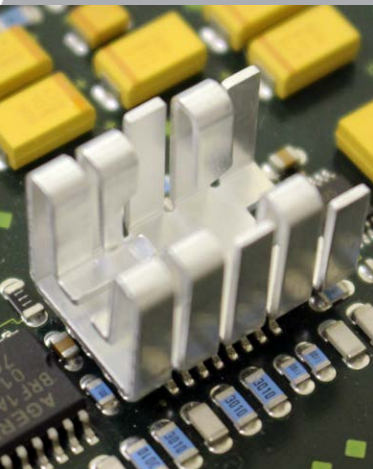

89-27 Access Road, Norwood, MA 02062  
T: 781.769.2800 F: 781.769.9979 | [www.qats.com](http://www.qats.com)



**ATS** ADVANCED  
THERMAL  
SOLUTIONS, INC.  
Innovations in Thermal Management®



# STAMPED STANDARD HEAT SINKS

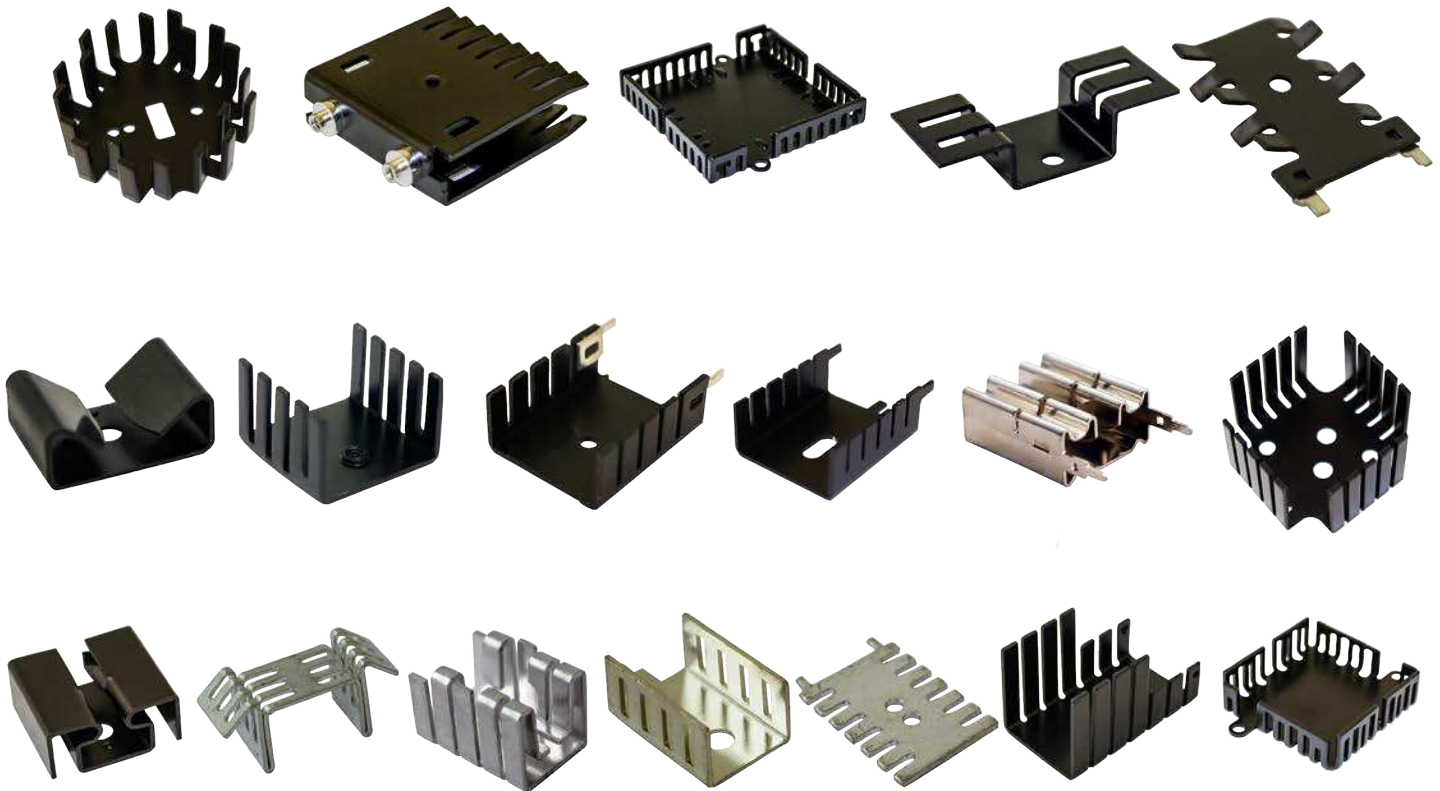

- » PC Board Level Standard Heat Sinks
- » Standard for TO220s, TO-3s, TO-5s, TO-126s, TO-127s, TO-202s, TO-218s
- » Aluminum anodized material with solderable tabs or aluminum tin plated, copper tin plated
- » Clips, Nuts, or Thermal pad optional

**ATS-PCB1001**

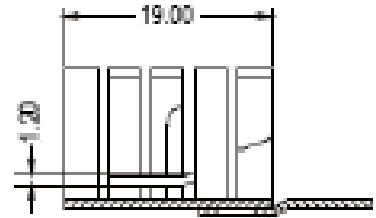
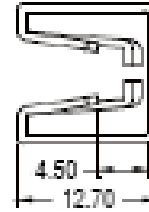
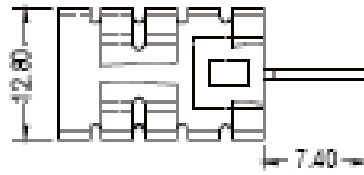
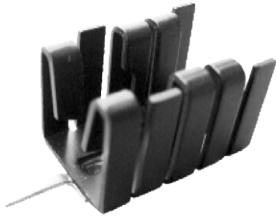

**Product Details**

| Length (mm) | Width (mm) | Height (mm) | Tim    | Material | Finish       | Packaged Cooled | Thermal Resistance (Natural Convection) | R @ 200 LFM | R @ 400 LFM | R @ 600 LFM | R @ 800 LFM |
|-------------|------------|-------------|--------|----------|--------------|-----------------|---|-------------|-------------|-------------|-------------|
| 19          | 12.8       | 12.7        | No TIM | Aluminum | Blk Anodized | TO-220,TO-262   | 27.3                                    | 10.2        | 7.0         | 5.7         | 4.8         |

**ATS-PCB1002**

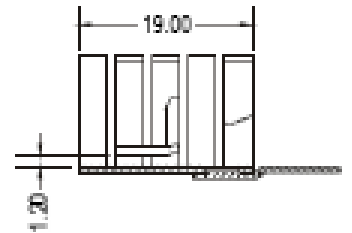
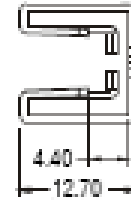
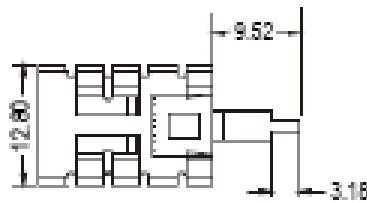
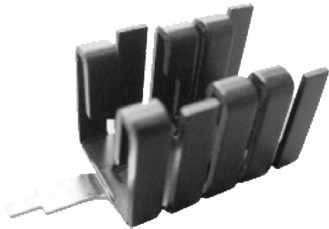

**Product Details**

| Length (mm) | Width (mm) | Height (mm) | Tim    | Material | Finish       | Packaged Cooled | Thermal Resistance (Natural Convection) | R @ 200 LFM | R @ 400 LFM | R @ 600 LFM | R @ 800 LFM |
|-------------|------------|-------------|--------|----------|--------------|-----------------|---|-------------|-------------|-------------|-------------|
| 19          | 12.8       | 12.7        | No TIM | Aluminum | Blk Anodized | TO-220,TO-262   | 27.3                                    | 10.2        | 7.0         | 5.7         | 4.8         |

**ATS-PCB1003**

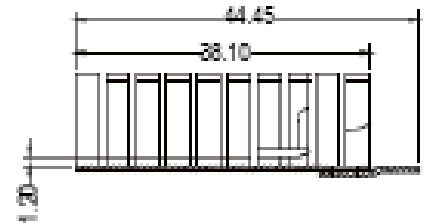
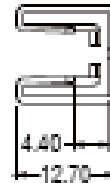
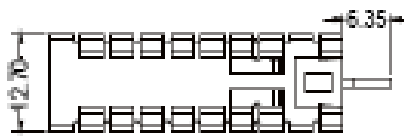
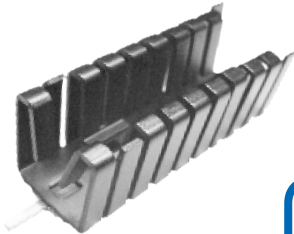

**Product Details**

| Length (mm) | Width (mm) | Height (mm) | Tim    | Material | Finish       | Packaged Cooled | Thermal Resistance (Natural Convection) | R @ 200 LFM | R @ 400 LFM | R @ 600 LFM | R @ 800 LFM |
|-------------|------------|-------------|--------|----------|--------------|-----------------|---|-------------|-------------|-------------|-------------|
| 38.1        | 12.7       | 12.7        | No TIM | Aluminum | Blk Anodized | TO-220          | 20.0                                    | 7.0         | 4.6         | 3.7         | 3.0         |

**ATS-PCB1004**

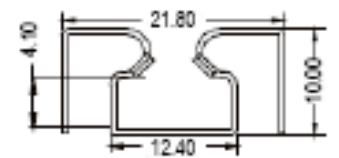
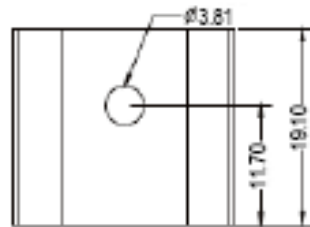
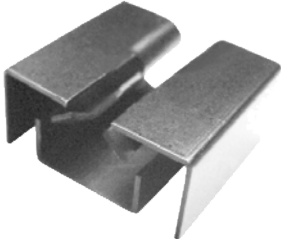

**Product Details**

| Length (mm) | Width (mm) | Height (mm) | Tim    | Material | Finish       | Packaged Cooled | Thermal Resistance (Natural Convection) | R @ 200 LFM | R @ 400 LFM | R @ 600 LFM | R @ 800 LFM |
|-------------|------------|-------------|--------|----------|--------------|-----------------|---|-------------|-------------|-------------|-------------|
| 19.1        | 21.8       | 10.0        | No TIM | Aluminum | Blk Anodized | TO-220          | 23.2                                    | 12.7        | 9.0         | 7.0         | 5.6         |

**ATS-PCB1005**

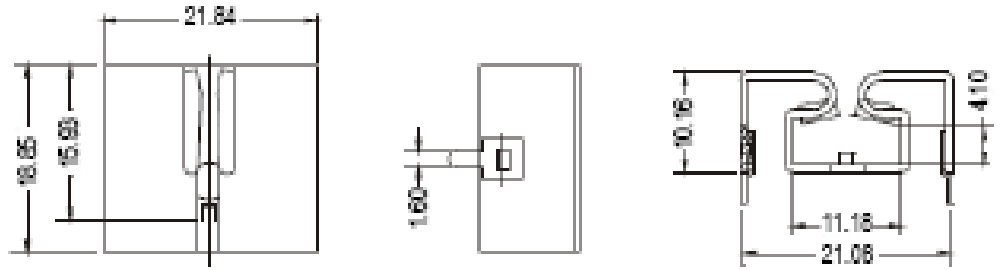
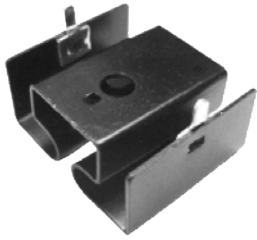

**Product Details**

| Length (mm) | Width (mm) | Height (mm) | Tim    | Material | Finish       | Packaged Cooled | Thermal Resistance (Natural Convection) | R @ 200 LFM | R @ 400 LFM | R @ 600 LFM | R @ 800 LFM |
|-------------|------------|-------------|--------|----------|--------------|-----------------|---|-------------|-------------|-------------|-------------|
| 18.9        | 21.8       | 10.         | No TIM | Aluminum | Blk Anodized | TO-220          | 23.2                                    | 12.0        | 8.2         | 6.0         | 4.2         |

**ATS-PCB1006**

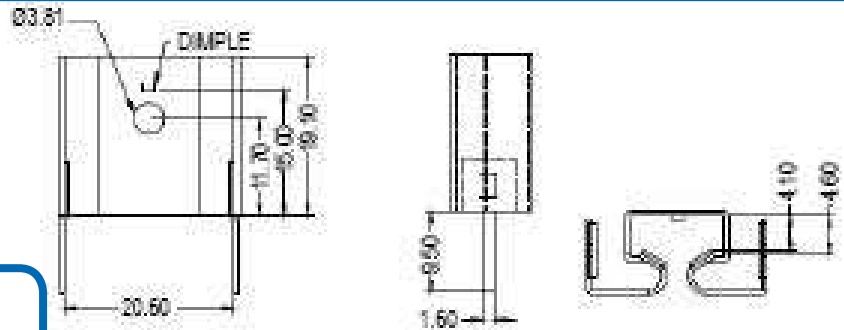

**Product Details**

| Length (mm) | Width (mm) | Height (mm) | Tim    | Material | Finish       | Packaged Cooled | Thermal Resistance (Natural Convection) | R @ 200 LFM | R @ 400 LFM | R @ 600 LFM | R @ 800 LFM |
|-------------|------------|-------------|--------|----------|--------------|-----------------|---|-------------|-------------|-------------|-------------|
| 19.1        | 21.8       | 9.9         | No TIM | Aluminum | Blk Anodized | TO-220          | 21.2                                    | 11.0        | 8.0         | 6.0         | 4.8         |

**ATS-PCB1007**

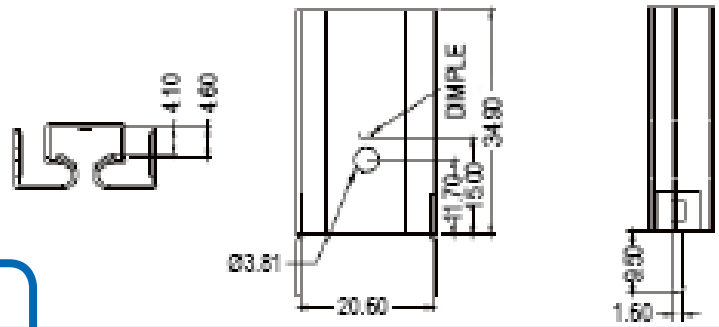

**Product Details**

| Length (mm) | Width (mm) | Height (mm) | Tim    | Material | Finish       | Packaged Cooled | Thermal Resistance (Natural Convection) | R @ 200 LFM | R @ 400 LFM | R @ 600 LFM | R @ 800 LFM |
|-------------|------------|-------------|--------|----------|--------------|-----------------|---|-------------|-------------|-------------|-------------|
| 34.9        | 21.8       | 10.0        | No TIM | Aluminum | Blk Anodized | TO-220          | 16.0                                    | 11.0        | 8.0         | 6.0         | 4.8         |

**ATS-PCB1008**

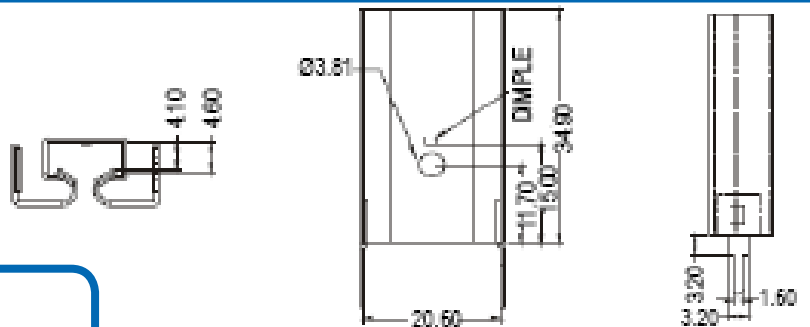

**Product Details**

| Length (mm) | Width (mm) | Height (mm) | Tim    | Material | Finish       | Packaged Cooled | Thermal Resistance (Natural Convection) | R @ 200 LFM | R @ 400 LFM | R @ 600 LFM | R @ 800 LFM |
|-------------|------------|-------------|--------|----------|--------------|-----------------|---|-------------|-------------|-------------|-------------|
| 34.9        | 21.8       | 10.0        | No TIM | Aluminum | Blk Anodized | TO-220          | 16.0                                    | 11.0        | 8.0         | 6.0         | 4.8         |

**ATS-PCB1009**

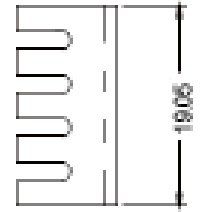
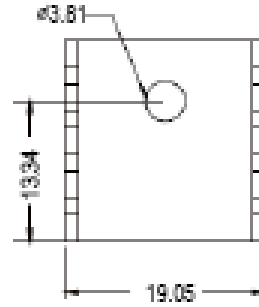
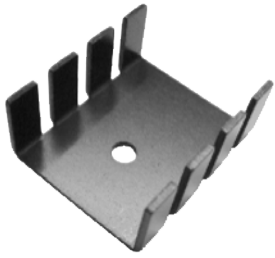

**Product Details**

| Length (mm) | Width (mm) | Height (mm) | Tim    | Material | Finish       | Packaged Cooled | Thermal Resistance (Natural Convection) | R @ 200 LFM | R @ 400 LFM | R @ 600 LFM | R @ 800 LFM |
|-------------|------------|-------------|--------|----------|--------------|-----------------|---|-------------|-------------|-------------|-------------|
| 19.         | 19.        | 9.5         | No TIM | Aluminum | Blk Anodized | TO-220          | 24.0                                    | 10.0        | 6.1         | 5.0         | 4.0         |

**ATS-PCB1010**

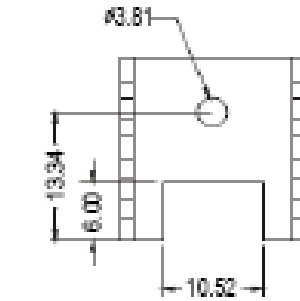
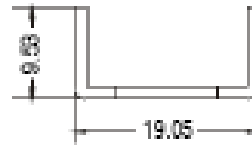

**Product Details**

| Length (mm) | Width (mm) | Height (mm) | Tim    | Material | Finish       | Packaged Cooled | Thermal Resistance (Natural Convection) | R @ 200 LFM | R @ 400 LFM | R @ 600 LFM | R @ 800 LFM |
|-------------|------------|-------------|--------|----------|--------------|-----------------|---|-------------|-------------|-------------|-------------|
| 19.         | 19.        | 9.5         | No TIM | Aluminum | Blk Anodized | TO-220          | 24.0                                    | 10.0        | 6.1         | 5.0         | 4.0         |

**ATS-PCB1011**

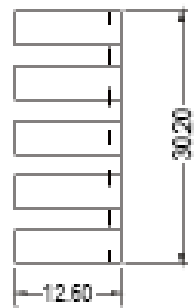
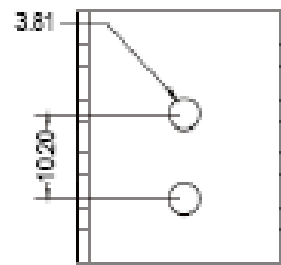
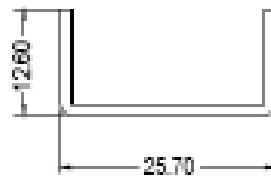
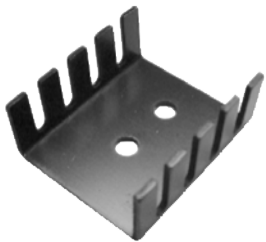

**Product Details**

| Length (mm) | Width (mm) | Height (mm) | Tim    | Material | Finish       | Packaged Cooled | Thermal Resistance (Natural Convection) | R @ 200 LFM | R @ 400 LFM | R @ 600 LFM | R @ 800 LFM |
|-------------|------------|-------------|--------|----------|--------------|-----------------|---|-------------|-------------|-------------|-------------|
| 30.2        | 25.7       | 12.6        | No TIM | Aluminum | Blk Anodized | TO-220          | 16.7                                    | 11.0        | 7.8         | 6.0         | 5.1         |

**ATS-PCB1012**

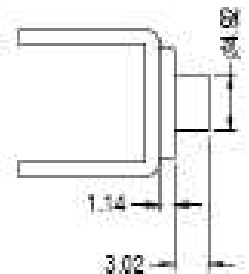
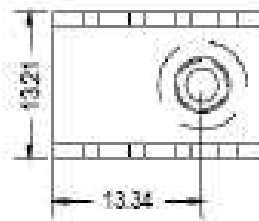
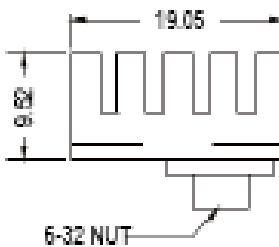
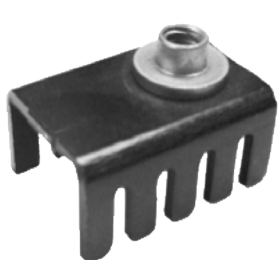

**Product Details**

| Length (mm) | Width (mm) | Height (mm) | Tim    | Material | Finish       | Packaged Cooled | Thermal Resistance (Natural Convection) | R @ 200 LFM | R @ 400 LFM | R @ 600 LFM | R @ 800 LFM |
|-------------|------------|-------------|--------|----------|--------------|-----------------|---|-------------|-------------|-------------|-------------|
| 19.         | 13.2       | 9.5         | No TIM | Aluminum | Blk Anodized | TO-220          | 25.9                                    | 12.0        | 8.1         | 7.4         | 7.1         |

**ATS-PCB1013**

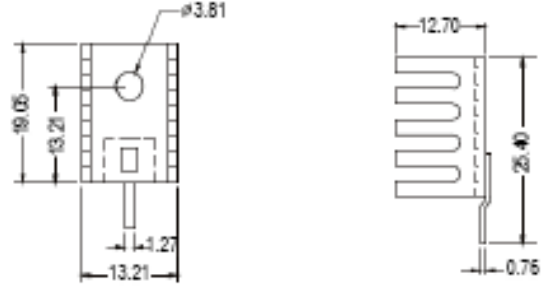

**Product Details**

| Length (mm) | Width (mm) | Height (mm) | Tim    | Material | Finish       | Packaged Cooled | Thermal Resistance (Natural Convection) | R @ 200 LFM | R @ 400 LFM | R @ 600 LFM | R @ 800 LFM |
|-------------|------------|-------------|--------|----------|--------------|-----------------|---|-------------|-------------|-------------|-------------|
| 19.         | 13.2       | 12.7        | No TIM | Aluminum | Blk Anodized | TO-220          | 24.4                                    | 9.5         | 6.8         | 6.4         | 6.0         |

**ATS-PCB1014**

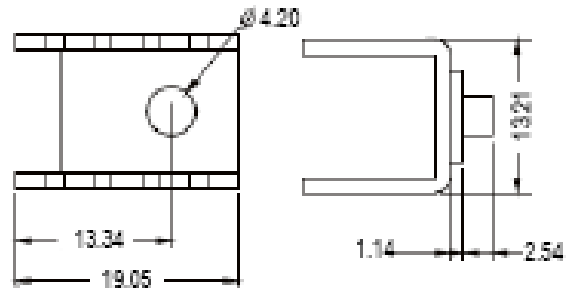
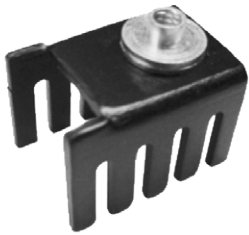

**Product Details**

| Length (mm) | Width (mm) | Height (mm) | Tim    | Material | Finish       | Packaged Cooled | Thermal Resistance (Natural Convection) | R @ 200 LFM | R @ 400 LFM | R @ 600 LFM | R @ 800 LFM |
|-------------|------------|-------------|--------|----------|--------------|-----------------|---|-------------|-------------|-------------|-------------|
| 19.         | 13.2       | 12.7        | No TIM | Aluminum | Blk Anodized | TO-220          | 24.4                                    | 9.5         | 6.8         | 6.4         | 6.0         |

**ATS-PCB1015**

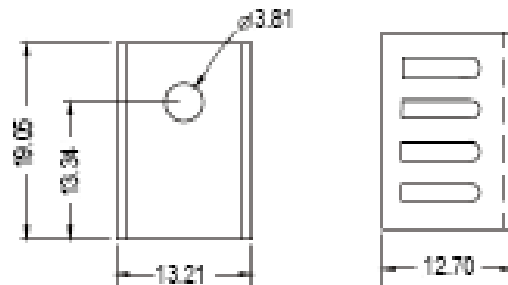

**Product Details**

| Length (mm) | Width (mm) | Height (mm) | Tim    | Material | Finish       | Packaged Cooled | Thermal Resistance (Natural Convection) | R @ 200 LFM | R @ 400 LFM | R @ 600 LFM | R @ 800 LFM |
|-------------|------------|-------------|--------|----------|--------------|-----------------|---|-------------|-------------|-------------|-------------|
| 19.         | 13.2       | 12.7        | No TIM | Aluminum | Blk Anodized | TO-220          | 25.0                                    | 10.2        | 7.5         | 6.1         | 6.0         |

**ATS-PCB1016**

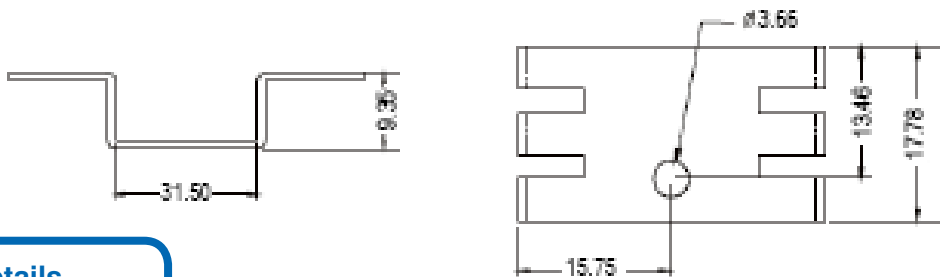

**Product Details**

| Length (mm) | Width (mm) | Height (mm) | Tim    | Material | Finish       | Packaged Cooled | Thermal Resistance (Natural Convection) | R @ 200 LFM | R @ 400 LFM | R @ 600 LFM | R @ 800 LFM |
|-------------|------------|-------------|--------|----------|--------------|-----------------|---|-------------|-------------|-------------|-------------|
| 17.8        | 31.5       | 9.4         | No TIM | Aluminum | Blk Anodized | TO-220          | 20.6                                    | 12.5        | 10.0        | 8.9         | 8.2         |

**ATS-PCB1017**

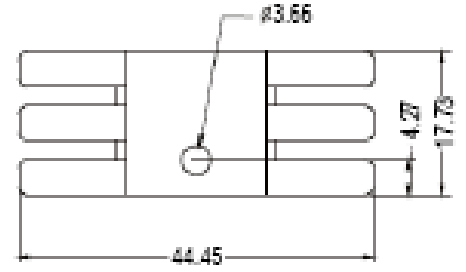
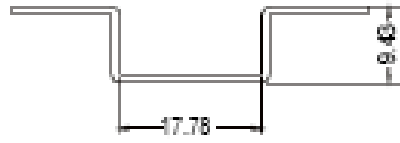
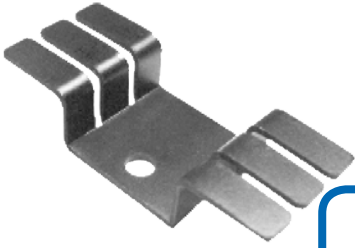

**Product Details**

| Length (mm) | Width (mm) | Height (mm) | Tim    | Material | Finish       | Packaged Cooled | Thermal Resistance (Natural Convection) | R @ 200 LFM | R @ 400 LFM | R @ 600 LFM | R @ 800 LFM |
|-------------|------------|-------------|--------|----------|--------------|-----------------|---|-------------|-------------|-------------|-------------|
| 17.7        | 44.5       | 9.4         | No TIM | Aluminum | Blk Anodized | TO-220, TO-202  | 15.6                                    | 7.1         | 5.5         | 4.2         | 3.2         |

**ATS-PCB1018**

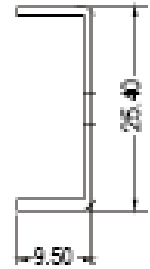
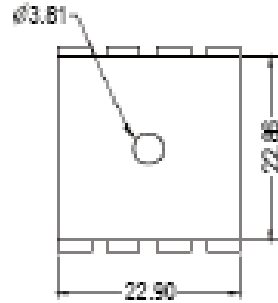
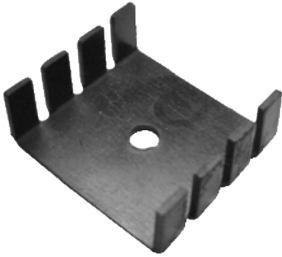

**Product Details**

| Length (mm) | Width (mm) | Height (mm) | Tim    | Material | Finish       | Packaged Cooled | Thermal Resistance (Natural Convection) | R @ 200 LFM | R @ 400 LFM | R @ 600 LFM | R @ 800 LFM |
|-------------|------------|-------------|--------|----------|--------------|-----------------|---|-------------|-------------|-------------|-------------|
| 22.9        | 25.4       | 9.5         | No TIM | Aluminum | Blk Anodized | TO-220          | 20.8                                    | 8.1         | 5.3         | 4.1         | 3.8         |

**ATS-PCB1019**

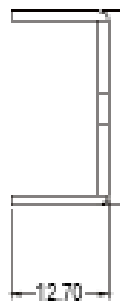
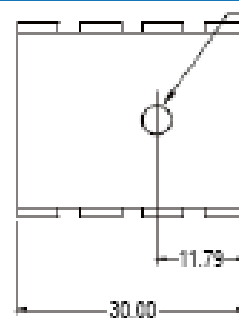
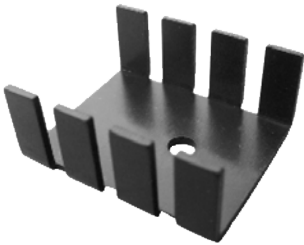

**Product Details**

| Length (mm) | Width (mm) | Height (mm) | Tim    | Material | Finish       | Packaged Cooled        | Thermal Resistance (Natural Convection) | R @ 200 LFM | R @ 400 LFM | R @ 600 LFM | R @ 800 LFM |
|-------------|------------|-------------|--------|----------|--------------|------------------------|---|-------------|-------------|-------------|-------------|
| 30.0        | 25.4       | 12.7        | No TIM | Aluminum | Blk Anodized | TO-220, TO-202, TO-220 | 22.0                                    | 10.1        | 7.0         | 5.0         | 4.2         |

**ATS-PCB1020**

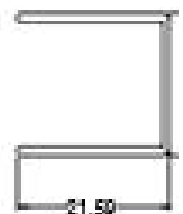
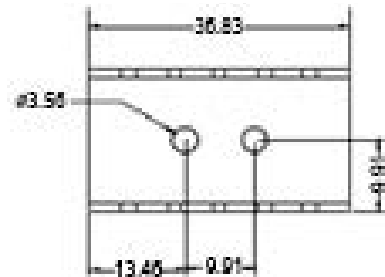

**Product Details**

| Length (mm) | Width (mm) | Height (mm) | Tim    | Material | Finish       | Packaged Cooled | Thermal Resistance (Natural Convection) | R @ 200 LFM | R @ 400 LFM | R @ 600 LFM | R @ 800 LFM |
|-------------|------------|-------------|--------|----------|--------------|-----------------|---|-------------|-------------|-------------|-------------|
| 36.8        | 19.8       | 21.6        | No TIM | Aluminum | Blk Anodized | TO-220          | 6.4                                     | 5.0         | 3.5         | 2.2         | 1.9         |



**ATS-PCB1021**

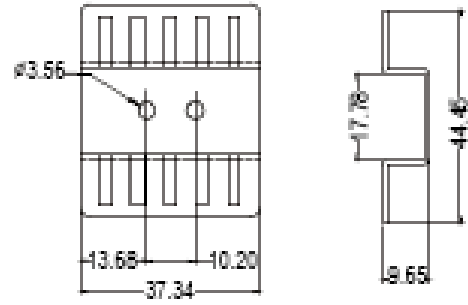
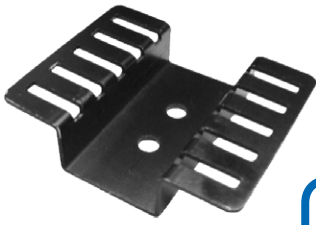

**Product Details**

| Length (mm) | Width (mm) | Height (mm) | Tim    | Material | Finish       | Packaged Cooled | Thermal Resistance (Natural Convection) | R @ 200 LFM | R @ 400 LFM | R @ 600 LFM | R @ 800 LFM |
|-------------|------------|-------------|--------|----------|--------------|-----------------|---|-------------|-------------|-------------|-------------|
| 37.3        | 44.5       | 9.7         | No TIM | Aluminum | Blk Anodized | TO-220          | 9.6                                     | 3.0         | 1.8         | 1.0         | 0.9         |

**ATS-PCB1022**

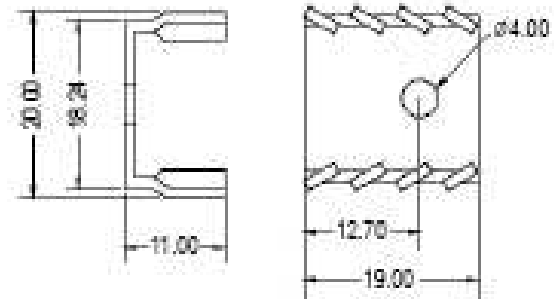
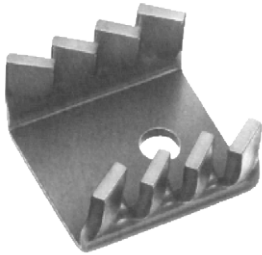

**Product Details**

| Length (mm) | Width (mm) | Height (mm) | Tim    | Material | Finish       | Packaged Cooled | Thermal Resistance (Natural Convection) | R @ 200 LFM | R @ 400 LFM | R @ 600 LFM | R @ 800 LFM |
|-------------|------------|-------------|--------|----------|--------------|-----------------|---|-------------|-------------|-------------|-------------|
| 19.0        | 20.0       | 11.0        | No TIM | Aluminum | Blk Anodized | TO-220          | 30.0                                    | 20.0        | 14.0        | 11.0        | 9.0         |

**ATS-PCB1023**

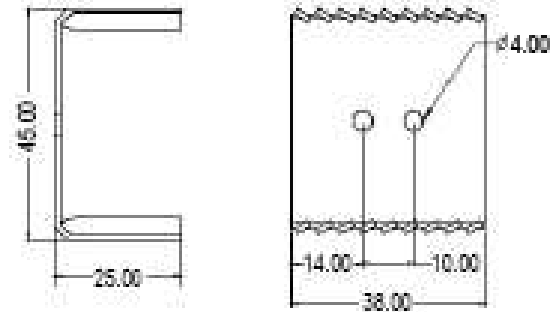
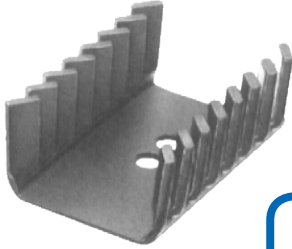

**Product Details**

| Length (mm) | Width (mm) | Height (mm) | Tim    | Material | Finish       | Packaged Cooled | Thermal Resistance (Natural Convection) | R @ 200 LFM | R @ 400 LFM | R @ 600 LFM | R @ 800 LFM |
|-------------|------------|-------------|--------|----------|--------------|-----------------|---|-------------|-------------|-------------|-------------|
| 38.0        | 45.0       | 25.0        | No TIM | Aluminum | Blk Anodized | TO-220          | 7.2                                     | 4.8         | 3.7         | 3.0         | 2.8         |

**ATS-PCB1024**

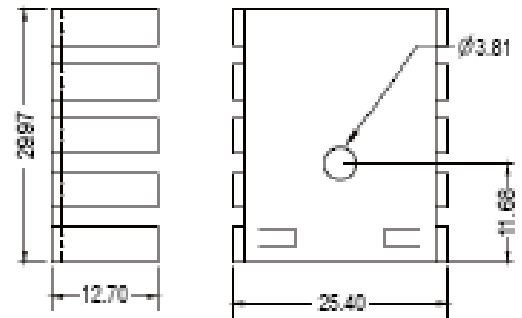

**Product Details**

| Length (mm) | Width (mm) | Height (mm) | Tim    | Material | Finish       | Packaged Cooled | Thermal Resistance (Natural Convection) | R @ 200 LFM | R @ 400 LFM | R @ 600 LFM | R @ 800 LFM |
|-------------|------------|-------------|--------|----------|--------------|-----------------|---|-------------|-------------|-------------|-------------|
| 30.0        | 25.4       | 12.7        | No TIM | Aluminum | Blk Anodized | TO-220          | 16.7                                    | 11.0        | 7.8         | 6.0         | 5.1         |

**ATS-PCB1025**

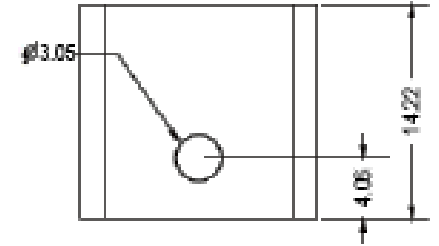
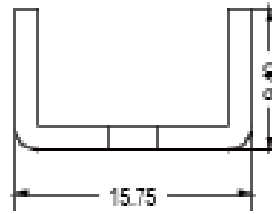

**Product Details**

| Length (mm) | Width (mm) | Height (mm) | Tim    | Material | Finish       | Packaged Cooled | Thermal Resistance (Natural Convection) | R @ 200 LFM | R @ 400 LFM | R @ 600 LFM | R @ 800 LFM |
|-------------|------------|-------------|--------|----------|--------------|-----------------|---|-------------|-------------|-------------|-------------|
| 14.2        | 15.8       | 9.4         | No TIM | Aluminum | Blk Anodized | TO-126          | 33.0                                    | 19.0        | 14.2        | 11.8        | 11.0        |

**ATS-PCB1026**

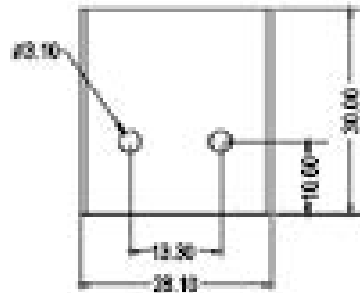

**Product Details**

| Length (mm) | Width (mm) | Height (mm) | Tim    | Material | Finish       | Packaged Cooled | Thermal Resistance (Natural Convection) | R @ 200 LFM | R @ 400 LFM | R @ 600 LFM | R @ 800 LFM |
|-------------|------------|-------------|--------|----------|--------------|-----------------|---|-------------|-------------|-------------|-------------|
| 30.0        | 28.1       | 23.0        | No TIM | Aluminum | Blk Anodized | TO-220          | 13.0                                    | 7.1         | 4.4         | 4.0         | 3.9         |

**ATS-PCB1027**

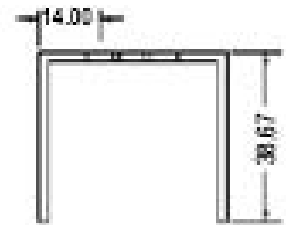
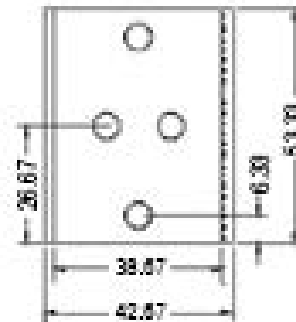

**Product Details**

| Length (mm) | Width (mm) | Height (mm) | Tim    | Material | Finish       | Packaged Cooled | Thermal Resistance (Natural Convection) | R @ 200 LFM | R @ 400 LFM | R @ 600 LFM | R @ 800 LFM |
|-------------|------------|-------------|--------|----------|--------------|-----------------|---|-------------|-------------|-------------|-------------|
| 53.3        | 42.7       | 38.7        | No TIM | Aluminum | Blk Anodized | TO-220          | 10.0                                    | 6.0         | 4.0         | 3.5         | 2.6         |

**ATS-PCB1028**

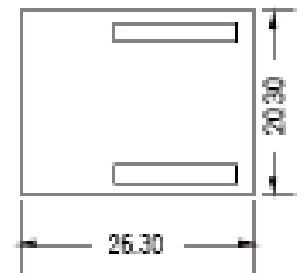
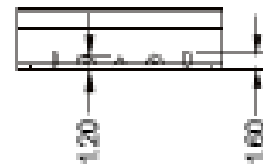
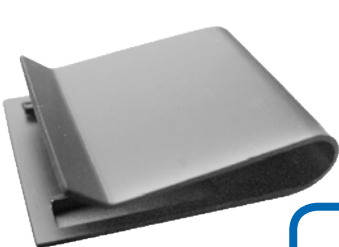

**Product Details**

| Length (mm) | Width (mm) | Height (mm) | Tim    | Material | Finish       | Packaged Cooled | Thermal Resistance (Natural Convection) | R @ 200 LFM | R @ 400 LFM | R @ 600 LFM | R @ 800 LFM |
|-------------|------------|-------------|--------|----------|--------------|-----------------|---|-------------|-------------|-------------|-------------|
| 26.3        | 20.3       | 6.1         | No TIM | Aluminum | Blk Anodized | TO-220          | 23.0                                    | 6.5         | 4.5         | 3.3         | 2.5         |

**ATS-PCB1029**

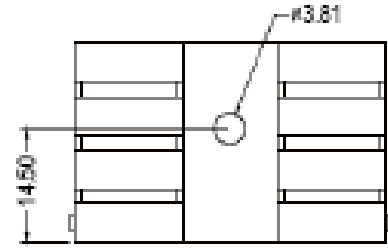
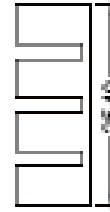
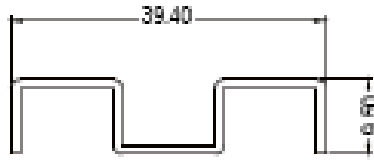
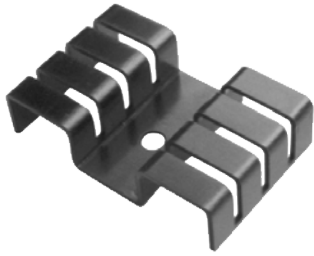

**Product Details**

| Length (mm) | Width (mm) | Height (mm) | Tim    | Material | Finish       | Packaged Cooled | Thermal Resistance (Natural Convection) | R @ 200 LFM | R @ 400 LFM | R @ 600 LFM | R @ 800 LFM |
|-------------|------------|-------------|--------|----------|--------------|-----------------|---|-------------|-------------|-------------|-------------|
| 25.4        | 39.4       | 9.5         | No TIM | Aluminum | Blk Anodized | TO-220          | 11.0                                    | 6.8         | 5.0         | 3.7         | 3.0         |

**ATS-PCB1030**

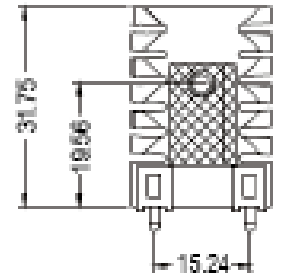
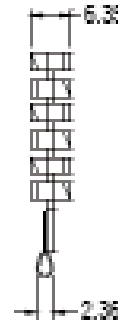

**Product Details**

| Length (mm) | Width (mm) | Height (mm) | Tim    | Material | Finish       | Packaged Cooled | Thermal Resistance (Natural Convection) | R @ 200 LFM | R @ 400 LFM | R @ 600 LFM | R @ 800 LFM |
|-------------|------------|-------------|--------|----------|--------------|-----------------|---|-------------|-------------|-------------|-------------|
| 31.8        | 22.2       | 6.4         | No TIM | Aluminum | Blk Anodized | TO-220          | 22.0                                    | 9.9         | 5.2         | 4.2         | 3.8         |

**ATS-PCB1031**

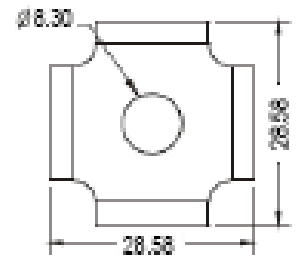
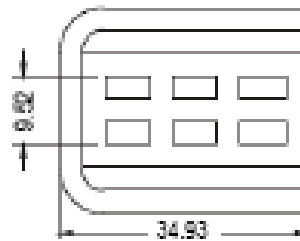

**Product Details**

| Length (mm) | Width (mm) | Height (mm) | Tim    | Material | Finish       | Packaged Cooled  | Thermal Resistance (Natural Convection) | R @ 200 LFM | R @ 400 LFM | R @ 600 LFM | R @ 800 LFM |
|-------------|------------|-------------|--------|----------|--------------|------------------|---|-------------|-------------|-------------|-------------|
| 28.6        | 28.6       | 34.9        | No TIM | Aluminum | Blk Anodized | BRIDGE RECTIFIER | 9.0                                     | 4.8         | 3.4         | 2.3         | 1.9         |

**ATS-PCB1032**

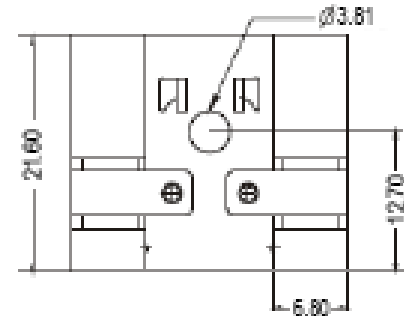
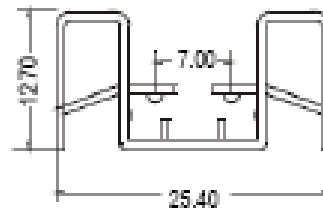
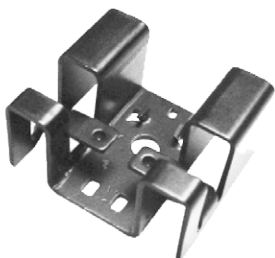

**Product Details**

| Length (mm) | Width (mm) | Height (mm) | Tim    | Material | Finish       | Packaged Cooled | Thermal Resistance (Natural Convection) | R @ 200 LFM | R @ 400 LFM | R @ 600 LFM | R @ 800 LFM |
|-------------|------------|-------------|--------|----------|--------------|-----------------|---|-------------|-------------|-------------|-------------|
| 21.6        | 25.4       | 12.7        | No TIM | Aluminum | Blk Anodized | TO-220          | 20.0                                    | 9.0         | 6.8         | 5.3         | 4.0         |

**ATS-PCB1033**

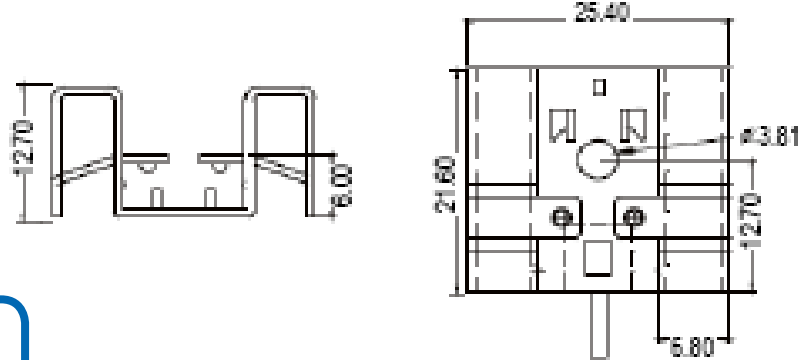
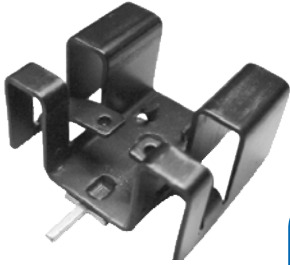

**Product Details**

| Length (mm) | Width (mm) | Height (mm) | Tim    | Material | Finish       | Packaged Cooled | Thermal Resistance (Natural Convection) | R @ 200 LFM | R @ 400 LFM | R @ 600 LFM | R @ 800 LFM |
|-------------|------------|-------------|--------|----------|--------------|-----------------|---|-------------|-------------|-------------|-------------|
| 21.6        | 25.4       | 12.7        | No TIM | Aluminum | Blk Anodized | TO-220          | 20.0                                    | 9.0         | 6.8         | 5.3         | 4.0         |

**ATS-PCB1034**

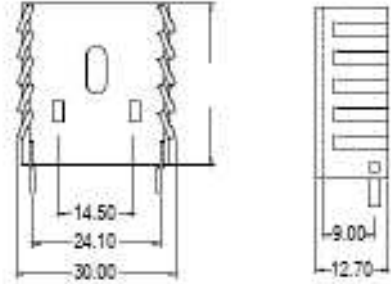

**Product Details**

| Length (mm) | Width (mm) | Height (mm) | Tim    | Material | Finish       | Packaged Cooled | Thermal Resistance (Natural Convection) | R @ 200 LFM | R @ 400 LFM | R @ 600 LFM | R @ 800 LFM |
|-------------|------------|-------------|--------|----------|--------------|-----------------|---|-------------|-------------|-------------|-------------|
| 30.2        | 30.0       | 12.7        | No TIM | Aluminum | Blk Anodized | TO-220          | 13.0                                    | 8.9         | 6.5         | 5.2         | 4.2         |

**ATS-PCB1035**

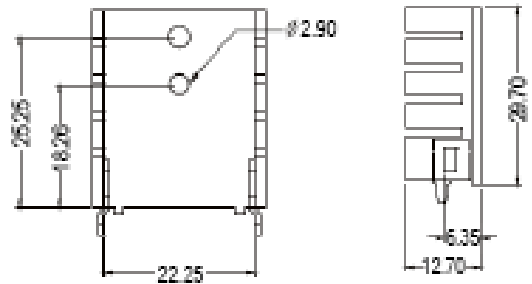
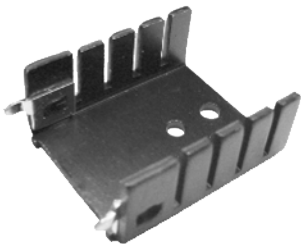

**Product Details**

| Length (mm) | Width (mm) | Height (mm) | Tim    | Material | Finish       | Packaged Cooled | Thermal Resistance (Natural Convection) | R @ 200 LFM | R @ 400 LFM | R @ 600 LFM | R @ 800 LFM |
|-------------|------------|-------------|--------|----------|--------------|-----------------|---|-------------|-------------|-------------|-------------|
| 30.0        | 25.4       | 12.7        | No TIM | Aluminum | Blk Anodized | TO-220          | 12.5                                    | 7.3         | 5.6         | 4.7         | 4.2         |

**ATS-PCB1036**

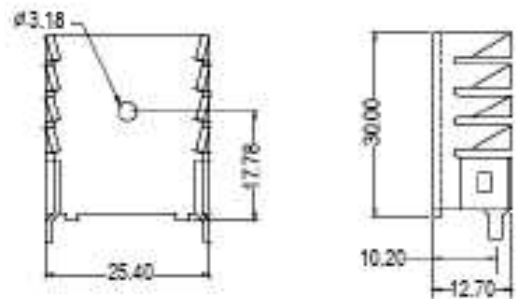
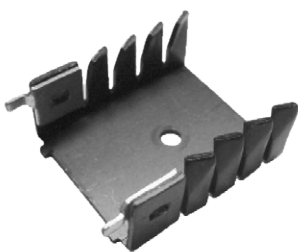

**Product Details**

| Length (mm) | Width (mm) | Height (mm) | Tim    | Material | Finish       | Packaged Cooled | Thermal Resistance (Natural Convection) | R @ 200 LFM | R @ 400 LFM | R @ 600 LFM | R @ 800 LFM |
|-------------|------------|-------------|--------|----------|--------------|-----------------|---|-------------|-------------|-------------|-------------|
| 30.0        | 25.4       | 12.7        | No TIM | Aluminum | Blk Anodized | TO-220          | 13.4                                    | 7.0         | 5.0         | 4.0         | 3.7         |



**ATS-PCB1037**

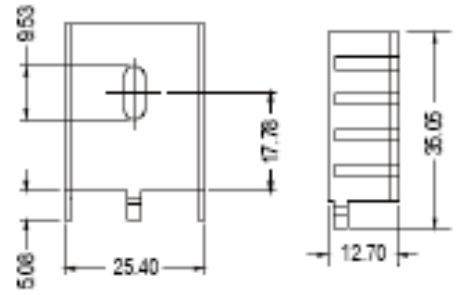
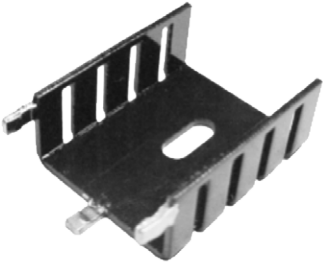

**Product Details**

| Length (mm) | Width (mm) | Height (mm) | Tim    | Material | Finish       | Packaged Cooled | Thermal Resistance (Natural Convection) | R @ 200 LFM | R @ 400 LFM | R @ 600 LFM | R @ 800 LFM |
|-------------|------------|-------------|--------|----------|--------------|-----------------|---|-------------|-------------|-------------|-------------|
| 35.1        | 25.4       | 12.7        | No TIM | Aluminum | Blk Anodized | TO-220          | 18.0                                    | 13.0        | 9.1         | 7.5         | 6.6         |

**ATS-PCB1038**

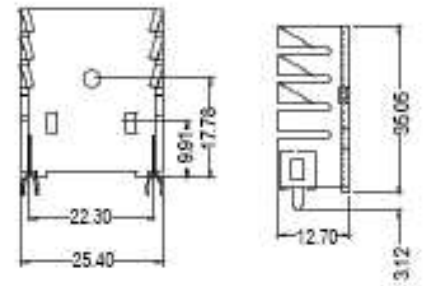
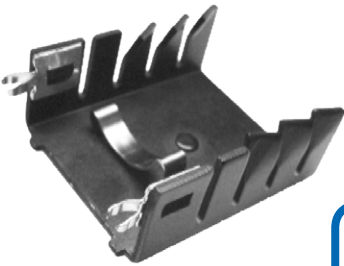

**Product Details**

| Length (mm) | Width (mm) | Height (mm) | Tim    | Material | Finish       | Packaged Cooled | Thermal Resistance (Natural Convection) | R @ 200 LFM | R @ 400 LFM | R @ 600 LFM | R @ 800 LFM |
|-------------|------------|-------------|--------|----------|--------------|-----------------|---|-------------|-------------|-------------|-------------|
| 30.0        | 25.4       | 12.7        | No TIM | Aluminum | Blk Anodized | TO-220          | 13.4                                    | 7.0         | 5.1         | 4.0         | 2.2         |

**ATS-PCB1039**

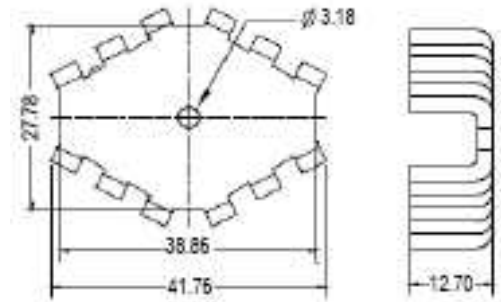

**Product Details**

| Length (mm) | Width (mm) | Height (mm) | Tim    | Material | Finish       | Packaged Cooled | Thermal Resistance (Natural Convection) | R @ 200 LFM | R @ 400 LFM | R @ 600 LFM | R @ 800 LFM |
|-------------|------------|-------------|--------|----------|--------------|-----------------|---|-------------|-------------|-------------|-------------|
| 41.8        | 32.8       | 12.7        | No TIM | Aluminum | Blk Anodized | TO-220          | 15.6                                    | 5.6         | 3.6         | 3.0         | 2.9         |

**ATS-PCB1040**

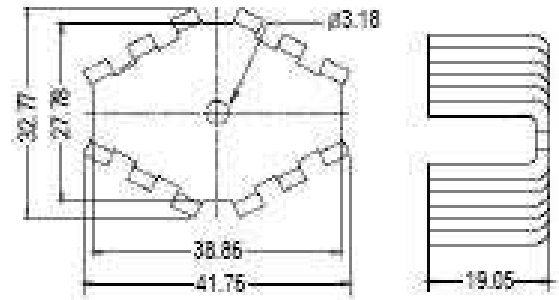
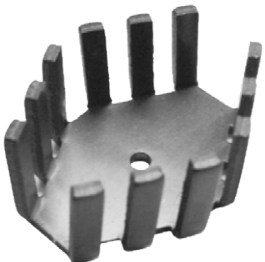

**Product Details**

| Length (mm) | Width (mm) | Height (mm) | Tim    | Material | Finish       | Packaged Cooled | Thermal Resistance (Natural Convection) | R @ 200 LFM | R @ 400 LFM | R @ 600 LFM | R @ 800 LFM |
|-------------|------------|-------------|--------|----------|--------------|-----------------|---|-------------|-------------|-------------|-------------|
| 41.8        | 32.8       | 19.1        | No TIM | Aluminum | Blk Anodized | TO-220          | 13.4                                    | 3.9         | 2.8         | 2.6         | 2.3         |

**ATS-PCB1041**

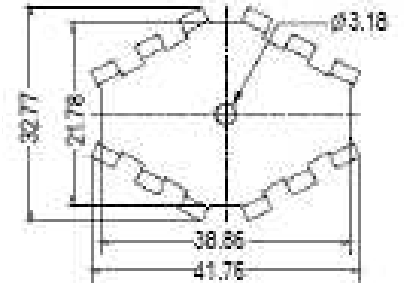
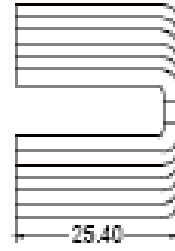
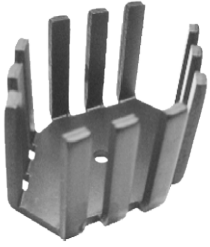

**Product Details**

| Length (mm) | Width (mm) | Height (mm) | Tim    | Material | Finish       | Packaged Cooled | Thermal Resistance (Natural Convection) | R @ 200 LFM | R @ 400 LFM | R @ 600 LFM | R @ 800 LFM |
|-------------|------------|-------------|--------|----------|--------------|-----------------|---|-------------|-------------|-------------|-------------|
| 41.8        | 32.8       | 25.4        | No TIM | Aluminum | Blk Anodized | TO-220          | 11.0                                    | 3.8         | 2.5         | 2.1         | 2.0         |

**ATS-PCB1042**

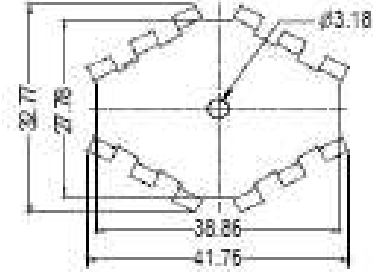
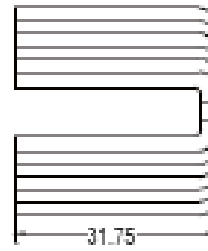

**Product Details**

| Length (mm) | Width (mm) | Height (mm) | Tim    | Material | Finish       | Packaged Cooled | Thermal Resistance (Natural Convection) | R @ 200 LFM | R @ 400 LFM | R @ 600 LFM | R @ 800 LFM |
|-------------|------------|-------------|--------|----------|--------------|-----------------|---|-------------|-------------|-------------|-------------|
| 41.8        | 32.8       | 31.8        | No TIM | Aluminum | Blk Anodized | TO-220          | 9.8                                     | 3.5         | 2.3         | 2.1         | 2.0         |

**ATS-PCB1043**

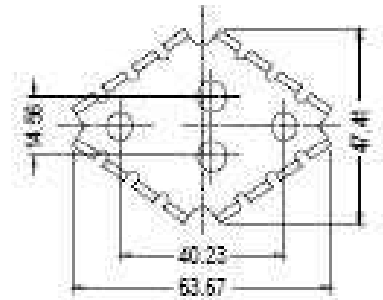
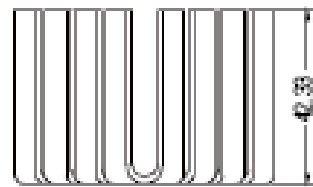

**Product Details**

| Length (mm) | Width (mm) | Height (mm) | Tim    | Material | Finish       | Packaged Cooled | Thermal Resistance (Natural Convection) | R @ 200 LFM | R @ 400 LFM | R @ 600 LFM | R @ 800 LFM |
|-------------|------------|-------------|--------|----------|--------------|-----------------|---|-------------|-------------|-------------|-------------|
| 63.7        | 47.4       | 42.3        | No TIM | Aluminum | Blk Anodized | TO-3            | 7.5                                     | 2.6         | 2.1         | 1.7         | 1.3         |

**ATS-PCB1044**

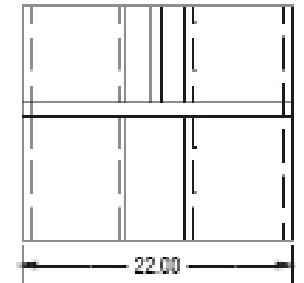
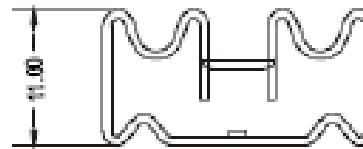
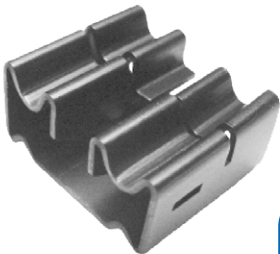

**Product Details**

| Length (mm) | Width (mm) | Height (mm) | Tim    | Material | Finish       | Packaged Cooled | Thermal Resistance (Natural Convection) | R @ 200 LFM | R @ 400 LFM | R @ 600 LFM | R @ 800 LFM |
|-------------|------------|-------------|--------|----------|--------------|-----------------|---|-------------|-------------|-------------|-------------|
| 19.0        | 22.0       | 11.0        | No TIM | Aluminum | Blk Anodized | TO-220          | 23.7                                    | 11.2        | 8.3         | 6.0         | 5.0         |

**ATS-PCB1045**

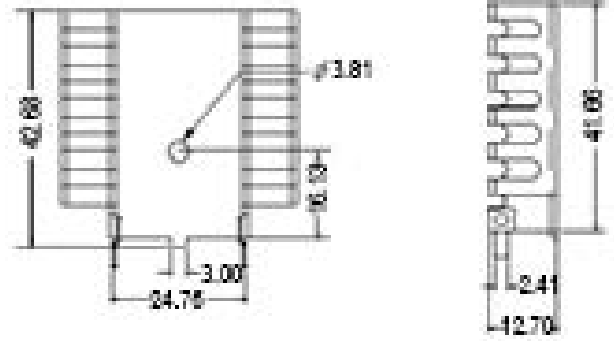
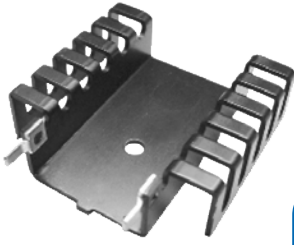

**Product Details**

| Length (mm) | Width (mm) | Height (mm) | Tim    | Material | Finish       | Packaged Cooled      | Thermal Resistance (Natural Convection) | R @ 200 LFM | R @ 400 LFM | R @ 600 LFM | R @ 800 LFM |
|-------------|------------|-------------|--------|----------|--------------|----------------------|---|-------------|-------------|-------------|-------------|
| 41.7        | 43.2       | 12.7        | No TIM | Aluminum | Blk Anodized | TO-220,TO-218,TO-247 | 8.6                                     | 6.3         | 4.5         | 3.5         | 2.8         |

**ATS-PCB1046**

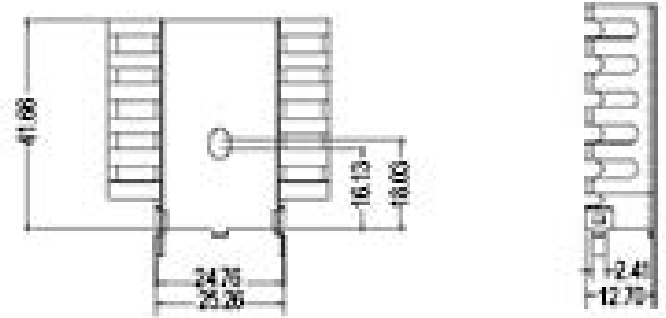
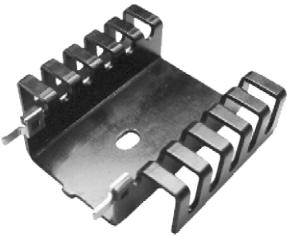

**Product Details**

| Length (mm) | Width (mm) | Height (mm) | Tim    | Material | Finish       | Packaged Cooled | Thermal Resistance (Natural Convection) | R @ 200 LFM | R @ 400 LFM | R @ 600 LFM | R @ 800 LFM |
|-------------|------------|-------------|--------|----------|--------------|-----------------|---|-------------|-------------|-------------|-------------|
| 41.2        | 43.2       | 12.7        | No TIM | Aluminum | Blk Anodized | TO-220, TO-218  | 8.6                                     | 6.3         | 4.5         | 3.5         | 2.8         |

**ATS-PCB1047**

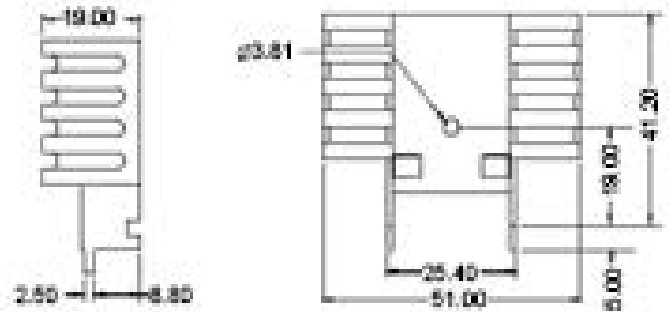
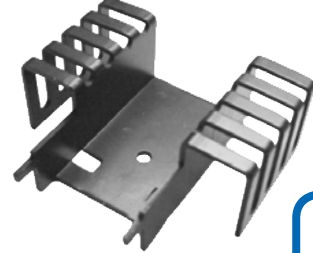

**Product Details**

| Length (mm) | Width (mm) | Height (mm) | Tim    | Material | Finish       | Packaged Cooled | Thermal Resistance (Natural Convection) | R @ 200 LFM | R @ 400 LFM | R @ 600 LFM | R @ 800 LFM |
|-------------|------------|-------------|--------|----------|--------------|-----------------|---|-------------|-------------|-------------|-------------|
| 46.2        | 51.0       | 19.0        | No TIM | Aluminum | Blk Anodized | TO-218, TO-247  | 8.0                                     | 2.4         | 1.8         | 1.2         | 1.0         |

**ATS-PCB1048**

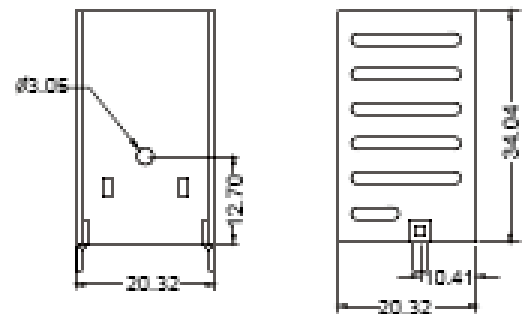

**Product Details**

| Length (mm) | Width (mm) | Height (mm) | Tim    | Material | Finish       | Packaged Cooled | Thermal Resistance (Natural Convection) | R @ 200 LFM | R @ 400 LFM | R @ 600 LFM | R @ 800 LFM |
|-------------|------------|-------------|--------|----------|--------------|-----------------|---|-------------|-------------|-------------|-------------|
| 34.0        | 20.3       | 20.3        | No TIM | Aluminum | Blk Anodized | TO-220          | 13.0                                    | 8.0         | 6.5         | 5.4         | 4.9         |

**ATS-PCB1049**

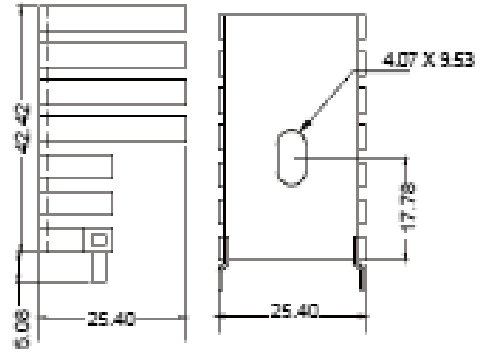
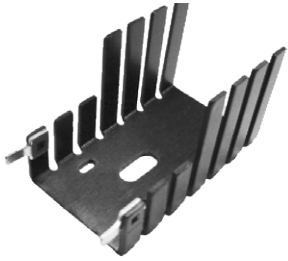

**Product Details**

| Length (mm) | Width (mm) | Height (mm) | Tim    | Material | Finish       | Packaged Cooled | Thermal Resistance (Natural Convection) | R @ 200 LFM | R @ 400 LFM | R @ 600 LFM | R @ 800 LFM |
|-------------|------------|-------------|--------|----------|--------------|-----------------|---|-------------|-------------|-------------|-------------|
| 42.4        | 25.4       | 25.4        | No TIM | Aluminum | Blk Anodized | TO-220          | 10.0                                    | 4.4         | 3.6         | 3.0         | 2.8         |

**ATS-PCB1050**

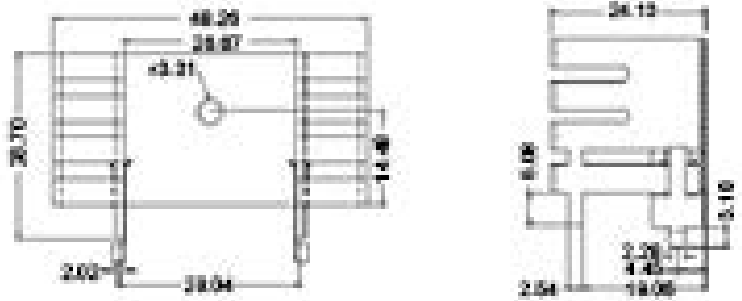

**Product Details**

| Length (mm) | Width (mm) | Height (mm) | Tim    | Material | Finish       | Packaged Cooled | Thermal Resistance (Natural Convection) | R @ 200 LFM | R @ 400 LFM | R @ 600 LFM | R @ 800 LFM |
|-------------|------------|-------------|--------|----------|--------------|-----------------|---|-------------|-------------|-------------|-------------|
| 28.7        | 48.3       | 24.1        | No TIM | Aluminum | Blk Anodized | TO-220          | 6.8                                     | 4.9         | 3.5         | 2.5         | 2.2         |

**ATS-PCB1051**

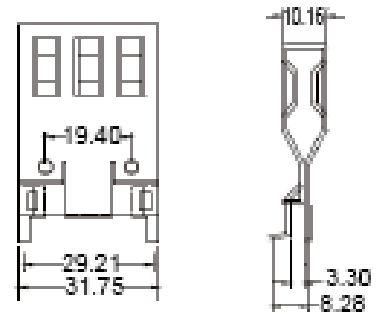

**Product Details**

| Length (mm) | Width (mm) | Height (mm) | Tim    | Material | Finish       | Packaged Cooled | Thermal Resistance (Natural Convection) | R @ 200 LFM | R @ 400 LFM | R @ 600 LFM | R @ 800 LFM |
|-------------|------------|-------------|--------|----------|--------------|-----------------|---|-------------|-------------|-------------|-------------|
| 43.2        | 31.8       | 10.2        | No TIM | Aluminum | Blk Anodized | 12-SIP          | 10.0                                    | 4.5         | 3.1         | 2.3         | 1.6         |

**ATS-PCB1052**

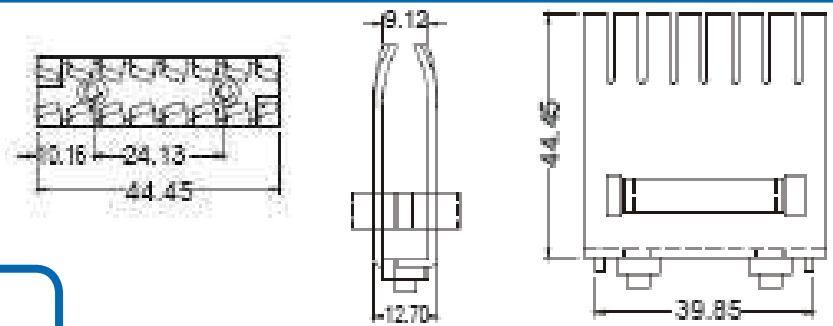
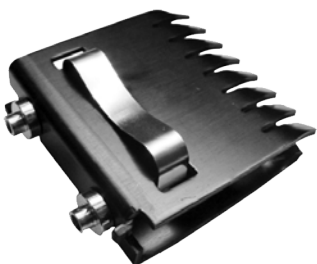

**Product Details**

| Length (mm) | Width (mm) | Height (mm) | Tim    | Material | Finish       | Packaged Cooled        | Thermal Resistance (Natural Convection) | R @ 200 LFM | R @ 400 LFM | R @ 600 LFM | R @ 800 LFM |
|-------------|------------|-------------|--------|----------|--------------|------------------------|---|-------------|-------------|-------------|-------------|
| 44.5        | 12.7       | 44.5        | No TIM | Aluminum | Blk Anodized | TO-220, TO-218, TO-247 | 6.3                                     | 2.3         | 1.5         | 1.1         | 0.8         |



**ATS-PCB1053**

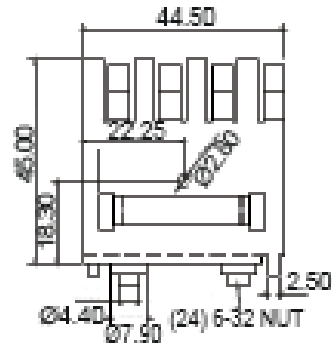
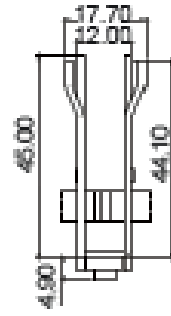
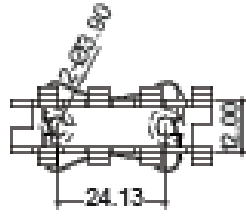
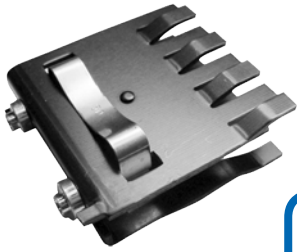

**Product Details**

| Length (mm) | Width (mm) | Height (mm) | Tim    | Material | Finish       | Packaged Cooled | Thermal Resistance (Natural Convection) | R @ 200 LFM | R @ 400 LFM | R @ 600 LFM | R @ 800 LFM |
|-------------|------------|-------------|--------|----------|--------------|-----------------|---|-------------|-------------|-------------|-------------|
| 44.5        | 17.7       | 45.0        | No TIM | Aluminum | Blk Anodized | TO-220          | 6.3                                     | 2.7         | 2.0         | 1.5         | 1.1         |

**ATS-PCB1054**

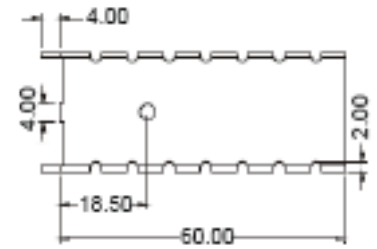
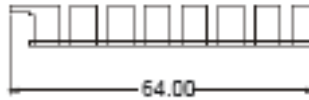
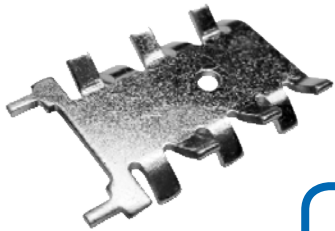

**Product Details**

| Length (mm) | Width (mm) | Height (mm) | Tim    | Material | Finish       | Packaged Cooled | Thermal Resistance (Natural Convection) | R @ 200 LFM | R @ 400 LFM | R @ 600 LFM | R @ 800 LFM |
|-------------|------------|-------------|--------|----------|--------------|-----------------|---|-------------|-------------|-------------|-------------|
| 60.0        | 25.0       | 8.5         | No TIM | Aluminum | Blk Anodized | TO-220          | 12.0                                    | 6.7         | 5.7         | 5.2         | 4.8         |

**ATS-PCB1055**

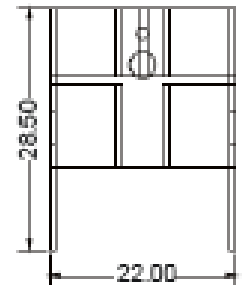
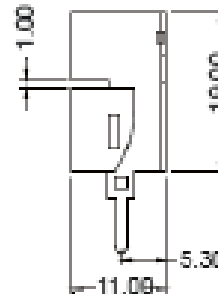
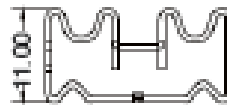

**Product Details**

| Length (mm) | Width (mm) | Height (mm) | Tim    | Material | Finish       | Packaged Cooled | Thermal Resistance (Natural Convection) | R @ 200 LFM | R @ 400 LFM | R @ 600 LFM | R @ 800 LFM |
|-------------|------------|-------------|--------|----------|--------------|-----------------|---|-------------|-------------|-------------|-------------|
| 19.0        | 22.0       | 11.0        | No TIM | Aluminum | Blk Anodized | TO-220          | 23.7                                    | 11.2        | 8.3         | 6.0         | 5.0         |

**ATS-PCB1056**

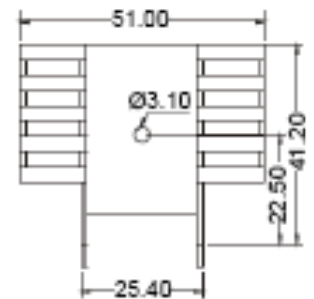
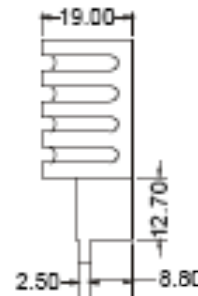
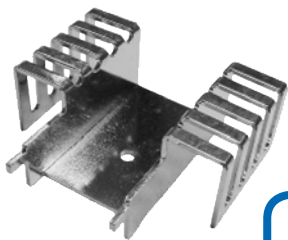

**Product Details**

| Length (mm) | Width (mm) | Height (mm) | Tim    | Material | Finish       | Packaged Cooled | Thermal Resistance (Natural Convection) | R @ 200 LFM | R @ 400 LFM | R @ 600 LFM | R @ 800 LFM |
|-------------|------------|-------------|--------|----------|--------------|-----------------|---|-------------|-------------|-------------|-------------|
| 41.2        | 51.0       | 19.0        | No TIM | Aluminum | Blk Anodized | TO-218, TO-247  | 8.0                                     | 2.4         | 1.8         | 1.2         | 1.0         |

**ATS-PCB1057**

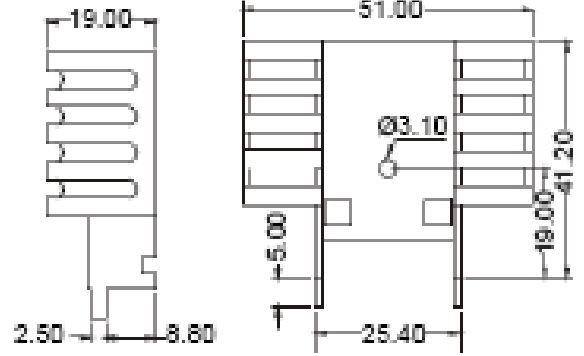
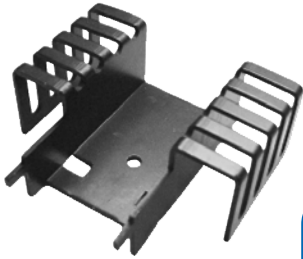

**Product Details**

| Length (mm) | Width (mm) | Height (mm) | Tim    | Material | Finish       | Packaged Cooled | Thermal Resistance (Natural Convection) | R @ 200 LFM | R @ 400 LFM | R @ 600 LFM | R @ 800 LFM |
|-------------|------------|-------------|--------|----------|--------------|-----------------|---|-------------|-------------|-------------|-------------|
| 41.2        | 51.0       | 19.0        | No TIM | Aluminum | Blk Anodized | TO-220          | 8.0                                     | 2.4         | 1.8         | 1.2         | 1.0         |

**ATS-PCB1058**

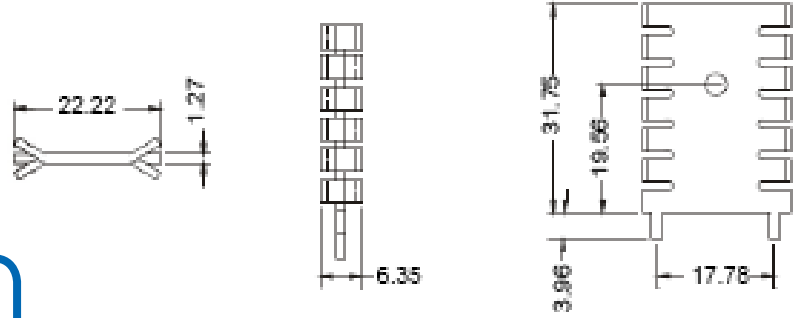
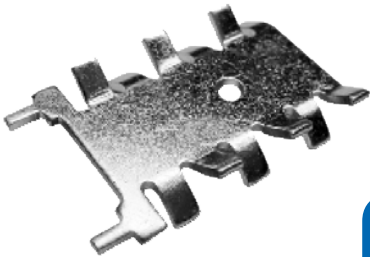

**Product Details**

| Length (mm) | Width (mm) | Height (mm) | Tim    | Material | Finish     | Packaged Cooled | Thermal Resistance (Natural Convection) | R @ 200 LFM | R @ 400 LFM | R @ 600 LFM | R @ 800 LFM |
|-------------|------------|-------------|--------|----------|------------|-----------------|---|-------------|-------------|-------------|-------------|
| 31.8        | 22.2       | 6.4         | No TIM | Copper   | Tin Plated | TO-220          | 24.0                                    | 8.8         | 6.1         | 4.1         | 4.0         |

**ATS-PCB1059**

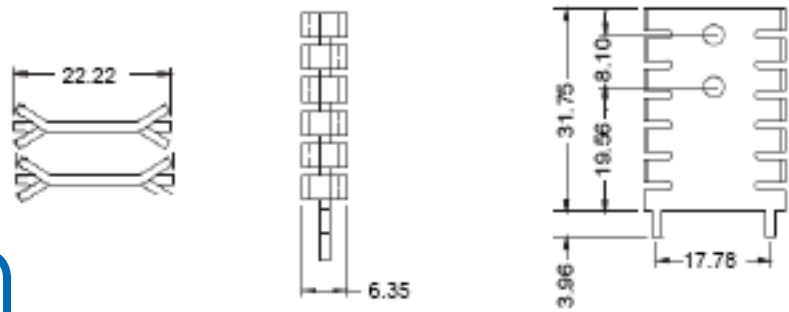
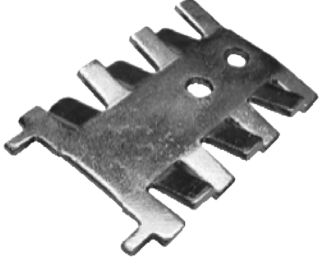

**Product Details**

| Length (mm) | Width (mm) | Height (mm) | Tim    | Material | Finish     | Packaged Cooled | Thermal Resistance (Natural Convection) | R @ 200 LFM | R @ 400 LFM | R @ 600 LFM | R @ 800 LFM |
|-------------|------------|-------------|--------|----------|------------|-----------------|---|-------------|-------------|-------------|-------------|
| 31.8        | 22.2       | 6.4         | No TIM | Copper   | Tin Plated | TO-220          | 24.0                                    | 8.8         | 6.1         | 4.1         | 4.0         |

**ATS-PCB1060**

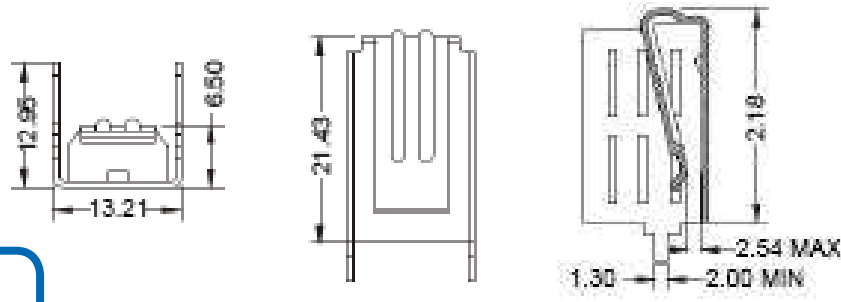
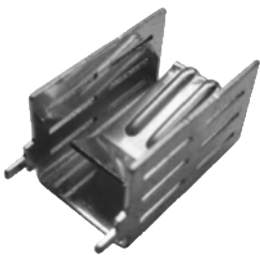

**Product Details**

| Length (mm) | Width (mm) | Height (mm) | Tim    | Material | Finish     | Packaged Cooled | Thermal Resistance (Natural Convection) | R @ 200 LFM | R @ 400 LFM | R @ 600 LFM | R @ 800 LFM |
|-------------|------------|-------------|--------|----------|------------|-----------------|---|-------------|-------------|-------------|-------------|
| 21.8        | 13.2       | 13.0        | No TIM | Copper   | Tin Plated | TO-220          | 19.7                                    | 8.0         | 6.8         | 5.7         | 5.0         |

**ATS-PCB1061**

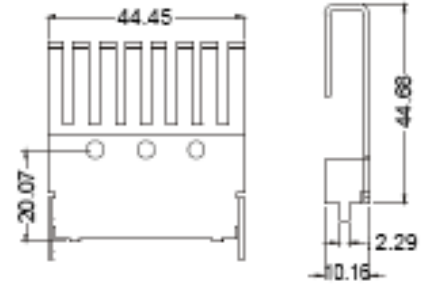
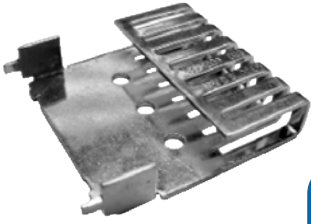

**Product Details**

| Length (mm) | Width (mm) | Height (mm) | Tim    | Material | Finish     | Packaged Cooled | Thermal Resistance (Natural Convection) | R @ 200 LFM | R @ 400 LFM | R @ 600 LFM | R @ 800 LFM |
|-------------|------------|-------------|--------|----------|------------|-----------------|---|-------------|-------------|-------------|-------------|
| 44.7        | 44.5       | 10.2        | No TIM | Copper   | Tin Plated | TO-126          | 15.0                                    | 6.5         | 5.1         | 4.3         | 3.6         |

**ATS-PCB1062**

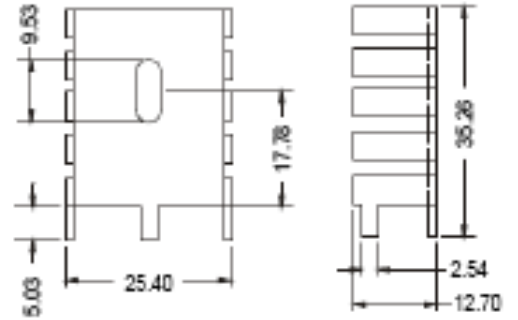
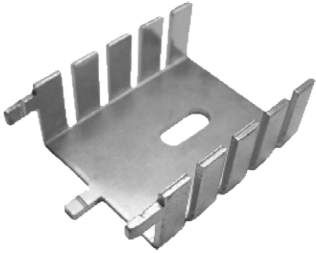

**Product Details**

| Length (mm) | Width (mm) | Height (mm) | Tim    | Material | Finish     | Packaged Cooled | Thermal Resistance (Natural Convection) | R @ 200 LFM | R @ 400 LFM | R @ 600 LFM | R @ 800 LFM |
|-------------|------------|-------------|--------|----------|------------|-----------------|---|-------------|-------------|-------------|-------------|
| 30.0        | 25.4       | 12.7        | No TIM | Copper   | Tin Plated | TO-220          | 13.0                                    | 7.0         | 5.0         | 4.0         | 3.1         |

**ATS-PCB1063**

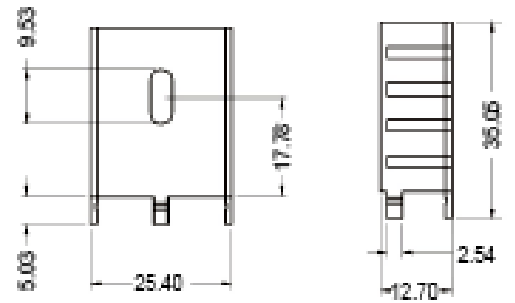
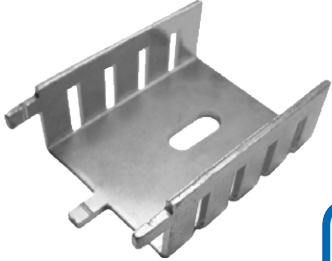

**Product Details**

| Length (mm) | Width (mm) | Height (mm) | Tim    | Material | Finish     | Packaged Cooled | Thermal Resistance (Natural Convection) | R @ 200 LFM | R @ 400 LFM | R @ 600 LFM | R @ 800 LFM |
|-------------|------------|-------------|--------|----------|------------|-----------------|---|-------------|-------------|-------------|-------------|
| 30.0        | 25.4       | 12.7        | No TIM | Copper   | Tin Plated | TO-220          | 18.0                                    | 13.0        | 9.1         | 7.5         | 6.8         |

**ATS-PCB1064**

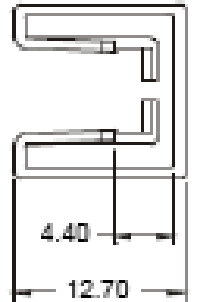
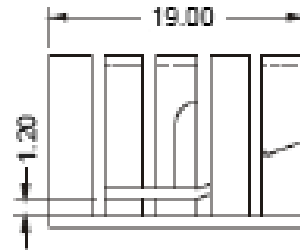
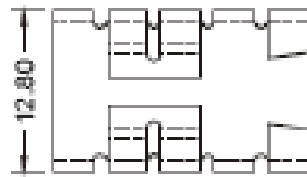

**Product Details**

| Length (mm) | Width (mm) | Height (mm) | Tim    | Material | Finish       | Packaged Cooled | Thermal Resistance (Natural Convection) | R @ 200 LFM | R @ 400 LFM | R @ 600 LFM | R @ 800 LFM |
|-------------|------------|-------------|--------|----------|--------------|-----------------|---|-------------|-------------|-------------|-------------|
| 19.0        | 12.8       | 12.7        | No TIM | Aluminum | Blk Anodized | TO-220          | 27.3                                    | 10.2        | 7.0         | 5.6         | 4.8         |

**ATS-PCB1065**

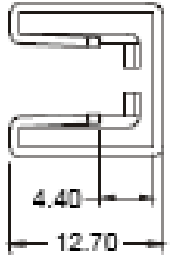
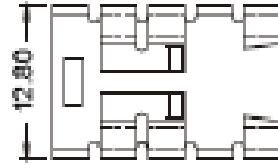
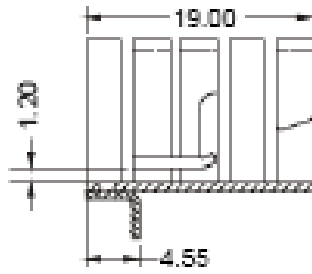
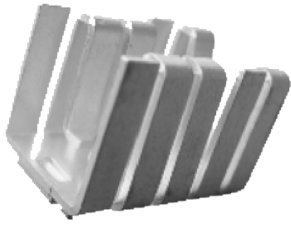

**Product Details**

| Length (mm) | Width (mm) | Height (mm) | Tim    | Material | Finish       | Packaged Cooled | Thermal Resistance (Natural Convection) | R @ 200 LFM | R @ 400 LFM | R @ 600 LFM | R @ 800 LFM |
|-------------|------------|-------------|--------|----------|--------------|-----------------|---|-------------|-------------|-------------|-------------|
| 19.0        | 12.8       | 12.7        | No TIM | Aluminum | Blk Anodized | TO-220          | 27.3                                    | 10.2        | 7.0         | 5.6         | 4.8         |

**ATS-PCB1066**

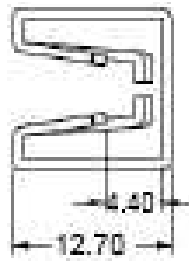
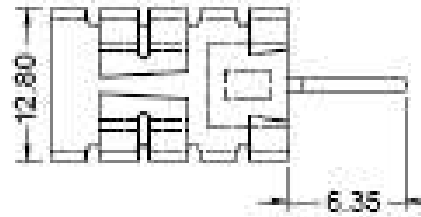
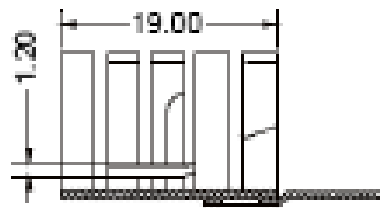

**Product Details**

| Length (mm) | Width (mm) | Height (mm) | Tim    | Material | Finish       | Packaged Cooled | Thermal Resistance (Natural Convection) | R @ 200 LFM | R @ 400 LFM | R @ 600 LFM | R @ 800 LFM |
|-------------|------------|-------------|--------|----------|--------------|-----------------|---|-------------|-------------|-------------|-------------|
| 19.0        | 12.8       | 12.7        | No TIM | Aluminum | Blk Anodized | TO-220, TO-262  | 27.3                                    | 10.2        | 7.0         | 5.6         | 4.8         |

**ATS-PCB1067**

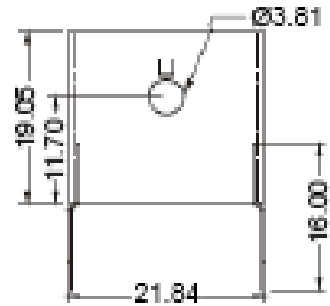
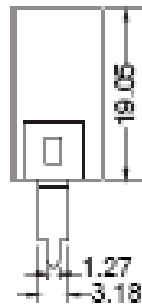
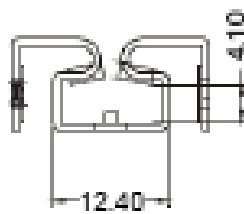
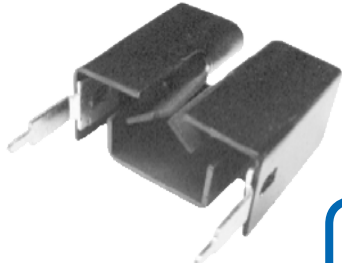

**Product Details**

| Length (mm) | Width (mm) | Height (mm) | Tim    | Material | Finish       | Packaged Cooled | Thermal Resistance (Natural Convection) | R @ 200 LFM | R @ 400 LFM | R @ 600 LFM | R @ 800 LFM |
|-------------|------------|-------------|--------|----------|--------------|-----------------|---|-------------|-------------|-------------|-------------|
| 19.1        | 21.8       | 9.9         | No TIM | Aluminum | Blk Anodized | TO-220          | 21.2                                    | 10.5        | 8.0         | 5.9         | 4.8         |

**ATS-PCB1068**

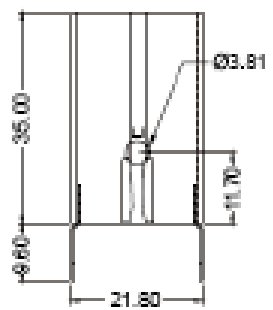
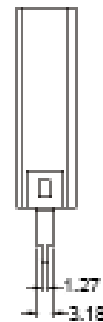
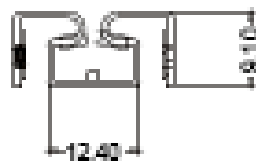

**Product Details**

| Length (mm) | Width (mm) | Height (mm) | Tim    | Material | Finish       | Packaged Cooled | Thermal Resistance (Natural Convection) | R @ 200 LFM | R @ 400 LFM | R @ 600 LFM | R @ 800 LFM |
|-------------|------------|-------------|--------|----------|--------------|-----------------|---|-------------|-------------|-------------|-------------|
| 34.9        | 21.8       | 9.1         | No TIM | Aluminum | Blk Anodized | TO-220          | 16.0                                    | 11.0        | 8.1         | 6.0         | 4.8         |



**ATS-PCB1069**

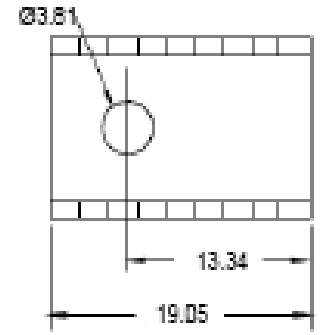
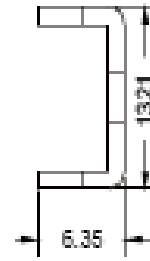
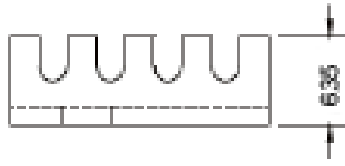

**Product Details**

| Length (mm) | Width (mm) | Height (mm) | Tim    | Material | Finish       | Packaged Cooled | Thermal Resistance (Natural Convection) | R @ 200 LFM | R @ 400 LFM | R @ 600 LFM | R @ 800 LFM |
|-------------|------------|-------------|--------|----------|--------------|-----------------|---|-------------|-------------|-------------|-------------|
| 19.1        | 13.2       | 6.4         | No TIM | Aluminum | Blk Anodized | TO-220          | 32.0                                    | 15.8        | 11.2        | 9.2         | 7.8         |

**ATS-PCB1070**

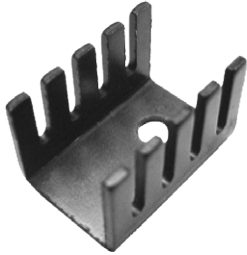

**Product Details**

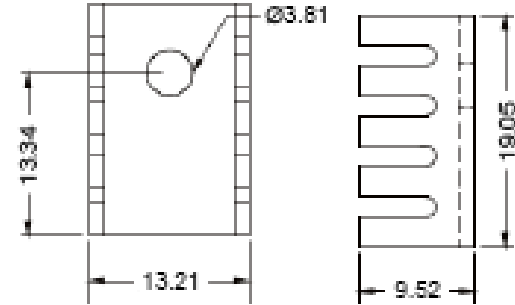

| Length (mm) | Width (mm) | Height (mm) | Tim    | Material | Finish       | Packaged Cooled | Thermal Resistance (Natural Convection) | R @ 200 LFM | R @ 400 LFM | R @ 600 LFM | R @ 800 LFM |
|-------------|------------|-------------|--------|----------|--------------|-----------------|---|-------------|-------------|-------------|-------------|
| 19.1        | 13.2       | 9.5         | No TIM | Aluminum | Blk Anodized | TO-220          | 25.9                                    | 15.8        | 11.2        | 9.2         | 7.8         |

**ATS-PCB1071**



**Product Details**

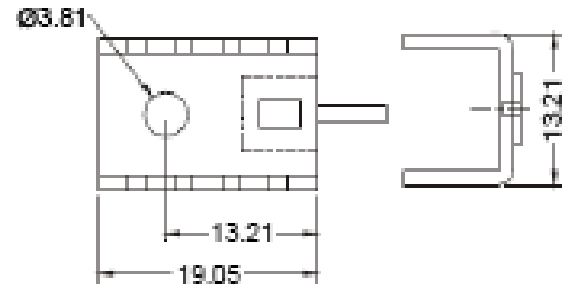
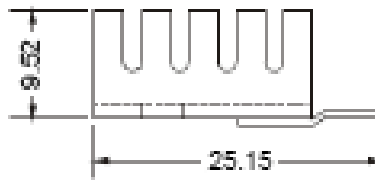

| Length (mm) | Width (mm) | Height (mm) | Tim    | Material | Finish       | Packaged Cooled | Thermal Resistance (Natural Convection) | R @ 200 LFM | R @ 400 LFM | R @ 600 LFM | R @ 800 LFM |
|-------------|------------|-------------|--------|----------|--------------|-----------------|---|-------------|-------------|-------------|-------------|
| 19.1        | 13.2       | 9.5         | No TIM | Aluminum | Blk Anodized | TO-220          | 25.9                                    | 15.6        | 11.0        | 9.0         | 7.6         |

**ATS-PCB1072**

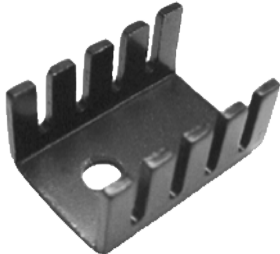

**Product Details**

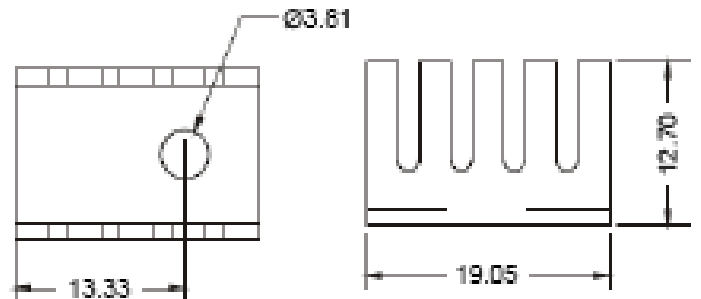
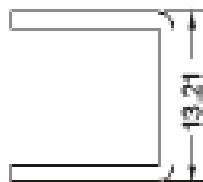

| Length (mm) | Width (mm) | Height (mm) | Tim    | Material | Finish       | Packaged Cooled | Thermal Resistance (Natural Convection) | R @ 200 LFM | R @ 400 LFM | R @ 600 LFM | R @ 800 LFM |
|-------------|------------|-------------|--------|----------|--------------|-----------------|---|-------------|-------------|-------------|-------------|
| 19.1        | 13.2       | 12.7        | No TIM | Aluminum | Blk Anodized | TO-220          | 24.4                                    | 9.5         | 7.0         | 6.3         | 6.0         |

**ATS-PCB1073**

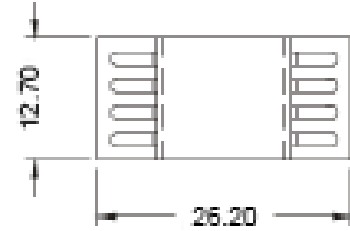
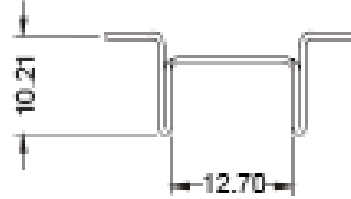
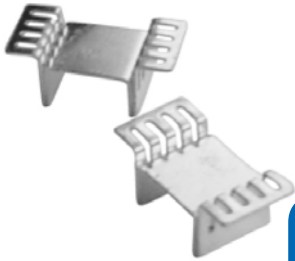

**Product Details**

| Length (mm) | Width (mm) | Height (mm) | Tim    | Material | Finish     | Packaged Cooled | Thermal Resistance (Natural Convection) | R @ 200 LFM | R @ 400 LFM | R @ 600 LFM | R @ 800 LFM |
|-------------|------------|-------------|--------|----------|------------|-----------------|---|-------------|-------------|-------------|-------------|
| 12.7        | 26.2       | 10.2        | No TIM | Copper   | Tin Plated | TO-263          | 18.0                                    | 9.5         | 6.8         | 5.2         | 5.0         |

**ATS-PCB1074**

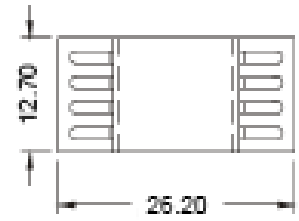
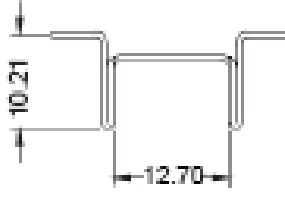
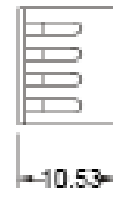
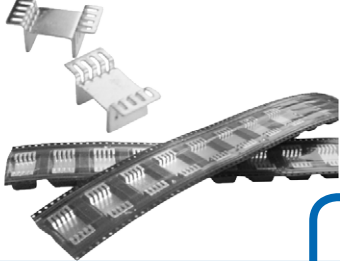

**Product Details**

| Length (mm) | Width (mm) | Height (mm) | Tim    | Material | Finish     | Packaged Cooled | Thermal Resistance (Natural Convection) | R @ 200 LFM | R @ 400 LFM | R @ 600 LFM | R @ 800 LFM |
|-------------|------------|-------------|--------|----------|------------|-----------------|---|-------------|-------------|-------------|-------------|
| 12.7        | 26.2       | 10.2        | No TIM | Copper   | Tin Plated | TO-263          | 18.0                                    | 9.5         | 6.8         | 5.2         | 5.0         |

**ATS-PCB1075**

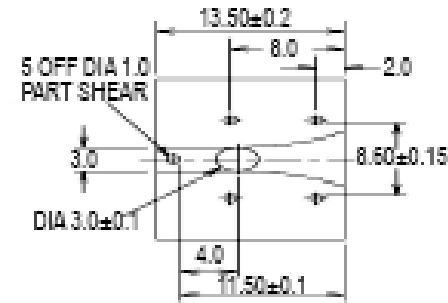
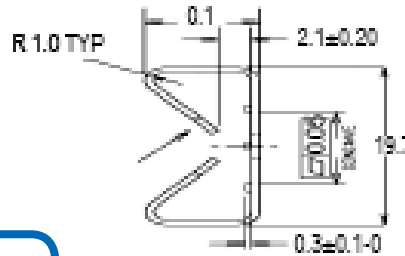

**Product Details**

| Length (mm) | Width (mm) | Height (mm) | Tim    | Material | Finish       | Packaged Cooled | Thermal Resistance (Natural Convection) | R @ 200 LFM | R @ 400 LFM | R @ 600 LFM | R @ 800 LFM |
|-------------|------------|-------------|--------|----------|--------------|-----------------|---|-------------|-------------|-------------|-------------|
| 13.2        | 19.7       | 8.1         | No TIM | Aluminum | Blk Anodized | TO-126          | 35.8                                    | 25.0        | 17.0        | 14.0        | 12.0        |

**ATS-PCB1076**

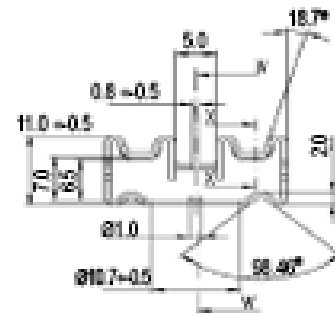
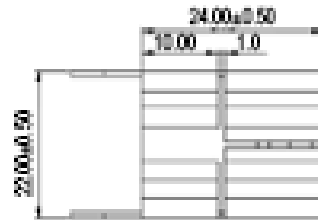
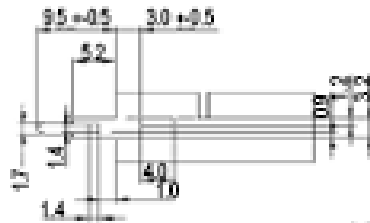

**Product Details**

| Length (mm) | Width (mm) | Height (mm) | Tim    | Material | Finish       | Packaged Cooled | Thermal Resistance (Natural Convection) | R @ 200 LFM | R @ 400 LFM | R @ 600 LFM | R @ 800 LFM |
|-------------|------------|-------------|--------|----------|--------------|-----------------|---|-------------|-------------|-------------|-------------|
| 24.0        | 22.0       | 11.0        | No TIM | Aluminum | Blk Anodized | TO-220          | 17.3                                    | 15.0        | 10.5        | 9.8         | 9.4         |

ATS-PCB1077

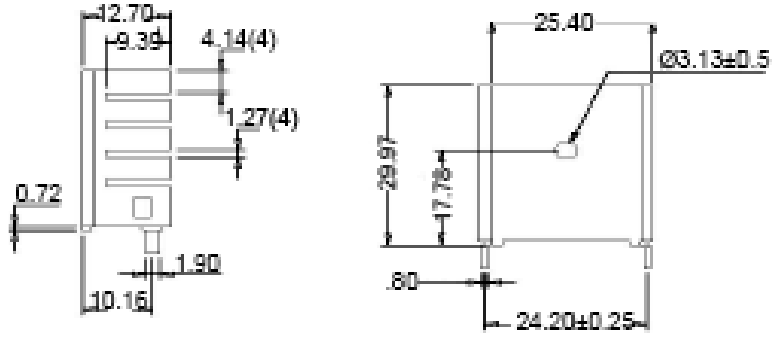
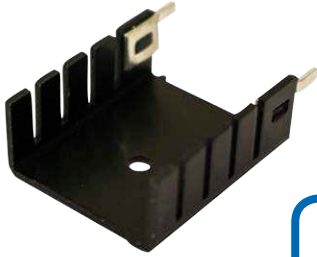

Product Details

| Length (mm) | Width (mm) | Height (mm) | Tim    | Material | Finish       | Packaged Cooled | Thermal Resistance (Natural Convection) | R @ 200 LFM | R @ 400 LFM | R @ 600 LFM | R @ 800 LFM |
|-------------|------------|-------------|--------|----------|--------------|-----------------|---|-------------|-------------|-------------|-------------|
| 30.0        | 25.4       | 12.7        | No TIM | Aluminum | Blk Anodized | TO-220          | 12.5                                    | 7.3         | 5.3         | 4.8         | 4.1         |

ATS-PCB1078

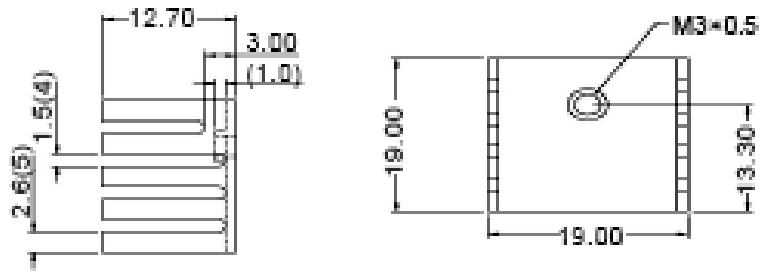

Product Details

| Length (mm) | Width (mm) | Height (mm) | Tim    | Material | Finish       | Packaged Cooled | Thermal Resistance (Natural Convection) | R @ 200 LFM | R @ 400 LFM | R @ 600 LFM | R @ 800 LFM |
|-------------|------------|-------------|--------|----------|--------------|-----------------|---|-------------|-------------|-------------|-------------|
| 19.0        | 19.0       | 12.7        | No TIM | Aluminum | Blk Anodized | TO-220          | 22.0                                    | 8.9         | 5.9         | 4.2         | 4.0         |

ATS-PCB1079

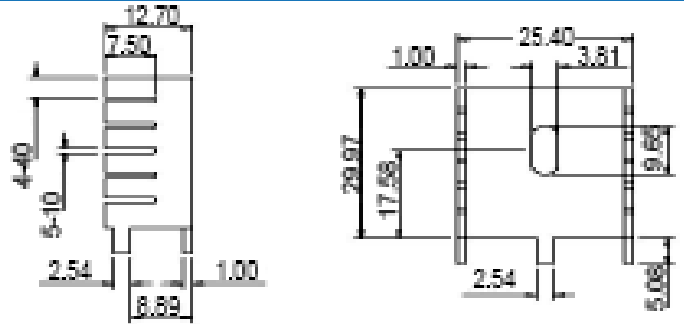
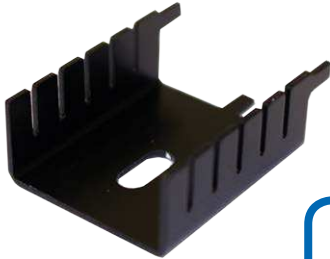

Product Details

| Length (mm) | Width (mm) | Height (mm) | Tim    | Material | Finish       | Packaged Cooled | Thermal Resistance (Natural Convection) | R @ 200 LFM | R @ 400 LFM | R @ 600 LFM | R @ 800 LFM |
|-------------|------------|-------------|--------|----------|--------------|-----------------|---|-------------|-------------|-------------|-------------|
| 30.0        | 25.4       | 12.7        | No TIM | Aluminum | Blk Anodized | TO-220          | 13.0                                    | 7.1         | 4.8         | 3.9         | 3.4         |

ATS-PCB1080

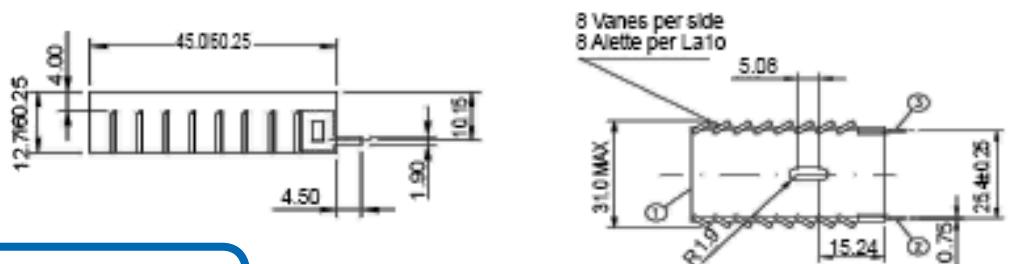

Product Details

| Length (mm) | Width (mm) | Height (mm) | Tim    | Material | Finish       | Packaged Cooled | Thermal Resistance (Natural Convection) | R @ 200 LFM | R @ 400 LFM | R @ 600 LFM | R @ 800 LFM |
|-------------|------------|-------------|--------|----------|--------------|-----------------|---|-------------|-------------|-------------|-------------|
| 45.0        | 31.0       | 12.7        | No TIM | Aluminum | Blk Anodized | TO-218, TO-220  | 13.0                                    | 9.0         | 7.0         | 7.0         | 7.0         |

**ATS-PCB1081**

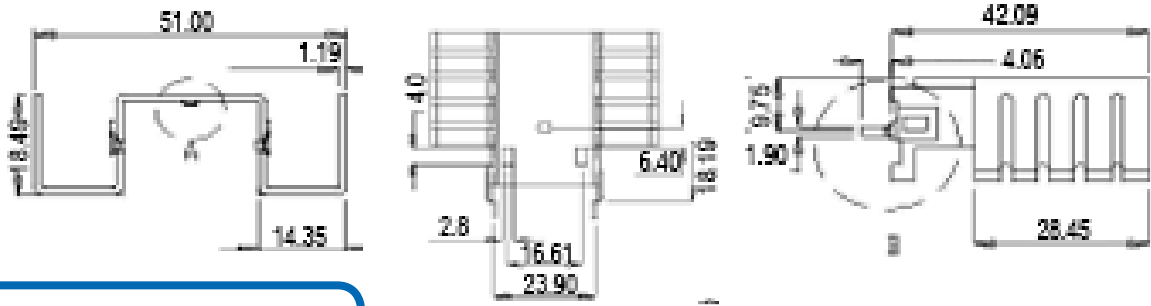
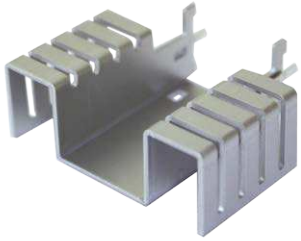

**Product Details**

| Length (mm) | Width (mm) | Height (mm) | Tim    | Material | Finish       | Packaged Cooled | Thermal Resistance (Natural Convection) | R @ 200 LFM | R @ 400 LFM | R @ 600 LFM | R @ 800 LFM |
|-------------|------------|-------------|--------|----------|--------------|-----------------|---|-------------|-------------|-------------|-------------|
| 42.1        | 51.0       | 18.5        | No TIM | Aluminum | Blk Anodized | TO-220          | 6.7                                     | 1.8         | 1.2         | 0.8         | 0.6         |

**ATS-PCB1082**

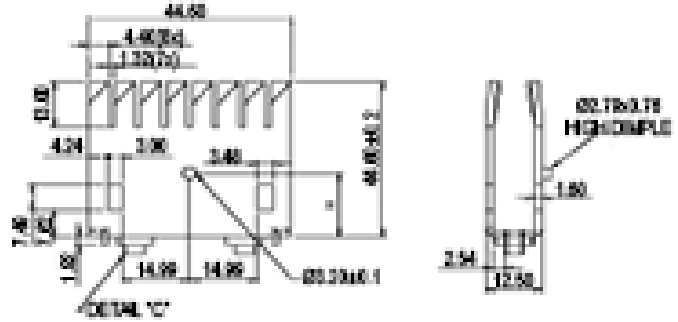

**Product Details**

| Length (mm) | Width (mm) | Height (mm) | Tim    | Material | Finish       | Packaged Cooled | Thermal Resistance (Natural Convection) | R @ 200 LFM | R @ 400 LFM | R @ 600 LFM | R @ 800 LFM |
|-------------|------------|-------------|--------|----------|--------------|-----------------|---|-------------|-------------|-------------|-------------|
| 44.6        | 12.5       | 44.6        | No TIM | Aluminum | Blk Anodized | TO-218          | 6.3                                     | 2.1         | 1.3         | 0.9         | 0.7         |

**ATS-PCB1083**

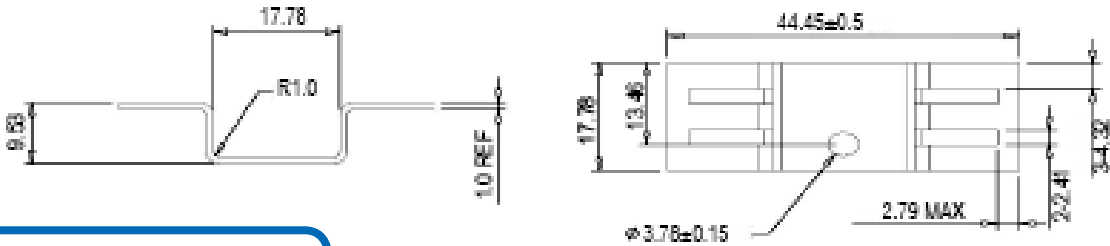

**Product Details**

| Length (mm) | Width (mm) | Height (mm) | Tim    | Material | Finish       | Packaged Cooled | Thermal Resistance (Natural Convection) | R @ 200 LFM | R @ 400 LFM | R @ 600 LFM | R @ 800 LFM |
|-------------|------------|-------------|--------|----------|--------------|-----------------|---|-------------|-------------|-------------|-------------|
| 17.8        | 44.5       | 9.5         | No TIM | Aluminum | Blk Anodized | TO-220          | 17.0                                    | 6.6         | 4.9         | 3.5         | 3.0         |

**ATS-PCB1084**

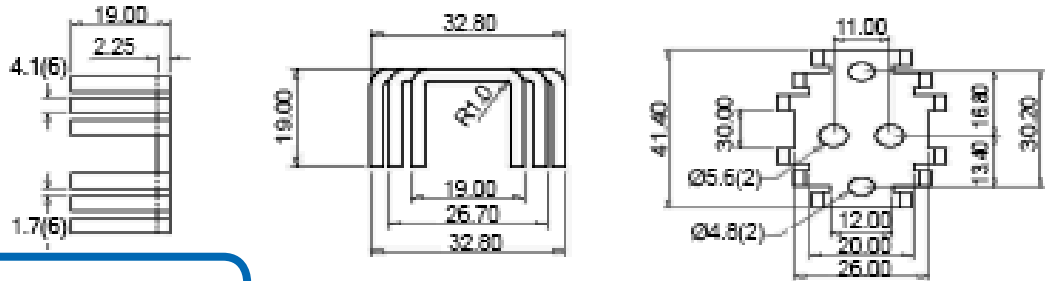

**Product Details**

| Length (mm) | Width (mm) | Height (mm) | Tim    | Material | Finish       | Packaged Cooled | Thermal Resistance (Natural Convection) | R @ 200 LFM | R @ 400 LFM | R @ 600 LFM | R @ 800 LFM |
|-------------|------------|-------------|--------|----------|--------------|-----------------|---|-------------|-------------|-------------|-------------|
| 41.4        | 32.8       | 19.0        | No TIM | Aluminum | Blk Anodized | TO-3            | 13.5                                    | 4.4         | 3.1         | 2.1         | 1.5         |





**ATS-PCB1089**

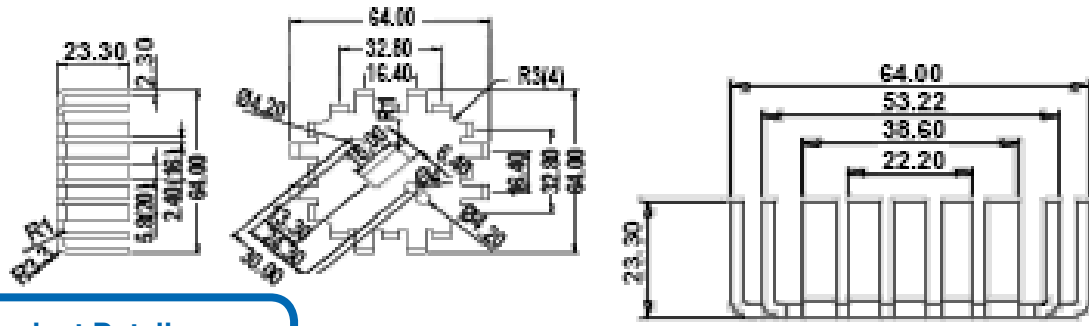

**Product Details**

| Length (mm) | Width (mm) | Height (mm) | Tim    | Material | Finish       | Packaged Cooled | Thermal Resistance (Natural Convection) | R @ 200 LFM | R @ 400 LFM | R @ 600 LFM | R @ 800 LFM |
|-------------|------------|-------------|--------|----------|--------------|-----------------|---|-------------|-------------|-------------|-------------|
| 64.0        | 64.0       | 23.3        | No TIM | Aluminum | Blk Anodized | TO-3            | 6.0                                     | 2.6         | 1.8         | 1.4         | 1.3         |

**ATS-PCB1090**

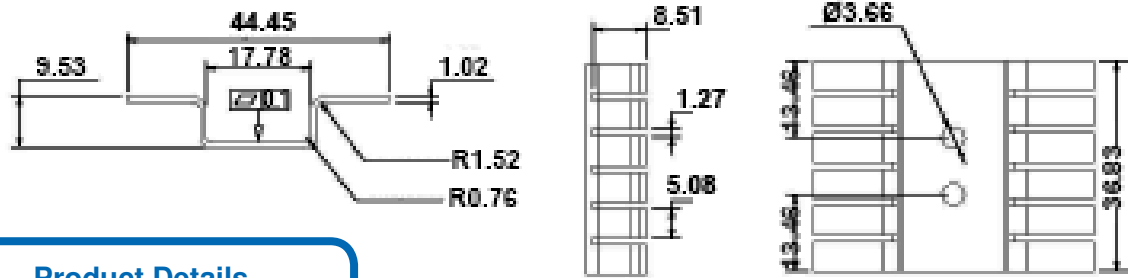
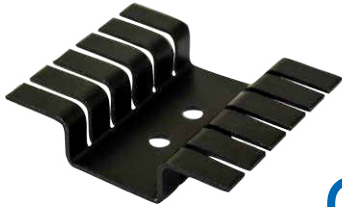

**Product Details**

| Length (mm) | Width (mm) | Height (mm) | Tim    | Material | Finish       | Packaged Cooled | Thermal Resistance (Natural Convection) | R @ 200 LFM | R @ 400 LFM | R @ 600 LFM | R @ 800 LFM |
|-------------|------------|-------------|--------|----------|--------------|-----------------|---|-------------|-------------|-------------|-------------|
| 36.8        | 44.5       | 9.5         | No TIM | Aluminum | Blk Anodized | TO-220 (DUAL)   | 9.6                                     | 3.0         | 1.7         | 1.0         | 0.9         |

**ATS-PCB1091**

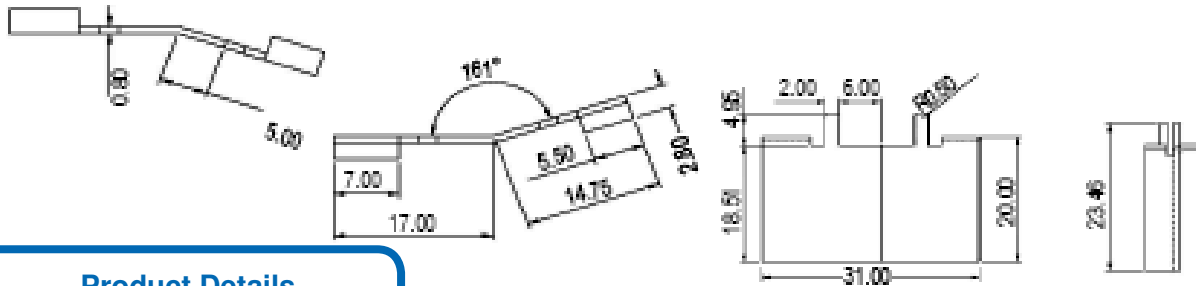

**Product Details**

| Length (mm) | Width (mm) | Height (mm) | Tim    | Material | Finish     | Packaged Cooled | Thermal Resistance (Natural Convection) | R @ 200 LFM | R @ 400 LFM | R @ 600 LFM | R @ 800 LFM |
|-------------|------------|-------------|--------|----------|------------|-----------------|---|-------------|-------------|-------------|-------------|
| 20.0        | 31.0       | 0.8         | No TIM | Steel    | Tin Plated | TO-220          | 25.0                                    | 13.0        | 11.2        | 10.3        | 9.5         |

**ATS-PCB1092**

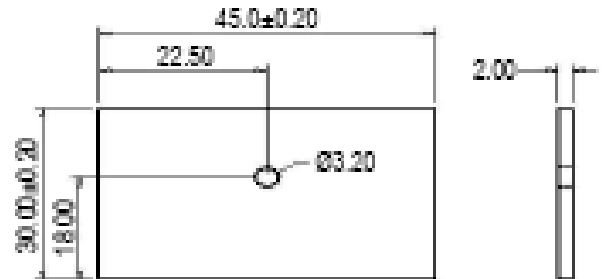

**Product Details**

| Length (mm) | Width (mm) | Height (mm) | Tim    | Material | Finish | Packaged Cooled | Thermal Resistance (Natural Convection) | R @ 200 LFM | R @ 400 LFM | R @ 600 LFM | R @ 800 LFM |
|-------------|------------|-------------|--------|----------|--------|-----------------|---|-------------|-------------|-------------|-------------|
| 30.0        | 45.0       | 2.0         | No TIM | Aluminum | None   | TO-220          | 23.0                                    | 11.0        | 9.2         | 8.3         | 7.5         |