



Chipsmall Limited consists of a professional team with an average of over 10 year of expertise in the distribution of electronic components. Based in Hongkong, we have already established firm and mutual-benefit business relationships with customers from,Europe,America and south Asia,supplying obsolete and hard-to-find components to meet their specific needs.

With the principle of “Quality Parts,Customers Priority,Honest Operation,and Considerate Service”,our business mainly focus on the distribution of electronic components. Line cards we deal with include Microchip,ALPS,ROHM,Xilinx,Pulse,ON,Everlight and Freescale. Main products comprise IC,Modules,Potentiometer,IC Socket,Relay,Connector.Our parts cover such applications as commercial,industrial, and automotives areas.

We are looking forward to setting up business relationship with you and hope to provide you with the best service and solution. Let us make a better world for our industry!



## Contact us

Tel: +86-755-8981 8866 Fax: +86-755-8427 6832

Email & Skype: info@chipsmall.com Web: www.chipsmall.com

Address: A1208, Overseas Decoration Building, #122 Zhenhua RD., Futian, Shenzhen, China





## ATS2012UV385

2.0 x 1.25 mm UV LED With Ceramic Substrate

### FEATURES

- 2.0 mm x 1.25 mm SMD LED, 0.75 mm thickness
- Low power consumption
- Wide viewing angle
- Package: 2000 pcs / reel
- Moisture sensitivity level: 1
- RoHS compliant

### APPLICATIONS

- Photocatalytic Purification
- Blood and Counterfeit money detection
- UV curing in nail salon, dental, and poster printing applications
- UV Sensor Light

### PACKAGE MATERIALS

- Material as follows:  
 Package: Ceramics  
 Encapsulating resin: Silicone resin  
 Electrodes: Au plating

### ATTENTION

Observe precautions for handling electrostatic discharge sensitive devices



### PACKAGE DIMENSIONS

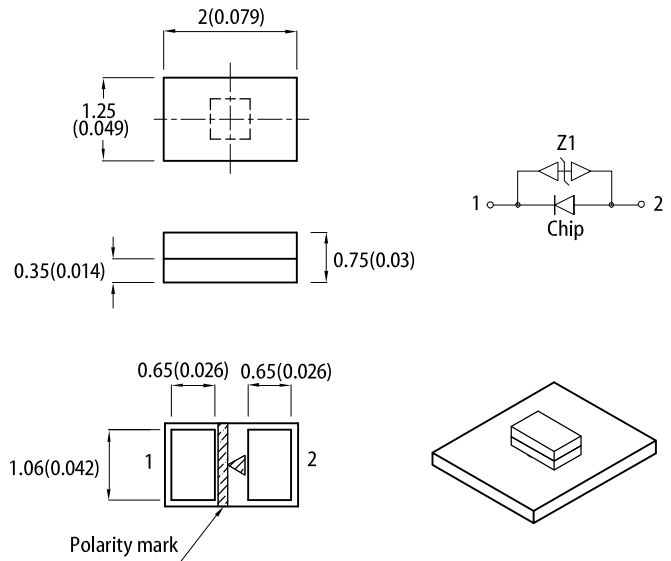

### RECOMMENDED SOLDERING PATTERN

(units : mm; tolerance : ± 0.1)

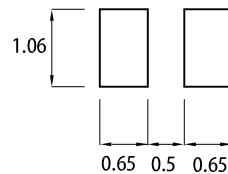

#### Notes:

1. All dimensions are in millimeters (inches).
2. Tolerance is ±0.25(0.01") unless otherwise noted.
3. The specifications, characteristics and technical data described in the datasheet are subject to change without prior notice.
4. The device has a single mounting surface. The device must be mounted according to the specifications.

### SELECTION GUIDE

Part Number	Emitting Color (Material)	Lens Type	Φe(mW) <sup>[2]</sup> @ 20mA		Viewing Angle <sup>[1]</sup>
			Min.	Typ.	2θ1/2
ATS2012UV385	Ultraviolet (InGaN)	Water Clear	10	16	150°

Notes:  
 1. θ1/2 is the angle from optical centerline where the radiant intensity is 1/2 of the optical peak value.  
 2. Radiant flux: +/-15%.  
 3. Radiant flux value is traceable to CIE127-2007 standards.

**ELECTRICAL / OPTICAL CHARACTERISTICS at T<sub>A</sub>=25°C**

Parameter	Symbol	Value	Unit
Wavelength at Peak Emission I <sub>F</sub> = 20mA [Min.]	$\lambda_{\text{peak}}$	380	nm
Wavelength at Peak Emission I <sub>F</sub> = 20mA [Typ.]		385	
Wavelength at Peak Emission I <sub>F</sub> = 20mA [Max.]		390	
Spectral Bandwidth at 50% $\Phi$ REL MAX I <sub>F</sub> = 20mA [Typ.]	$\Delta\lambda$	12	nm
Forward Voltage I <sub>F</sub> = 20mA [Typ.]	$V_F$ <sup>[1]</sup>	3.3	V
Forward Voltage I <sub>F</sub> = 20mA [Max.]		3.8	
Reverse Current (V <sub>R</sub> = 5V) [Max.]	I <sub>R</sub>	50	$\mu$ A
Temperature Coefficient of V <sub>F</sub> I <sub>F</sub> = 20mA, -10°C ≤ T ≤ 85°C	TC <sub>V</sub>	-3.0	mV/°C

## Notes:

1. Forward voltage:  $\pm 0.1V$ .

2. Wavelength value is traceable to CIE127-2007 standards.

3. Excess driving current and / or operating temperature higher than recommended conditions may result in severe light degradation or premature failure.

**ABSOLUTE MAXIMUM RATINGS at T<sub>A</sub>=25°C**

Parameter	Symbol	Value	Unit
Power Dissipation	P <sub>D</sub>	120	mW
Reverse Voltage	V <sub>R</sub>	5	V
Junction Temperature	T <sub>j</sub>	115	°C
Operating Temperature	T <sub>op</sub>	-40 to +85	°C
Storage Temperature	T <sub>stg</sub>	-40 to +85	°C
DC Forward Current	I <sub>F</sub>	30	mA
Peak Forward Current	I <sub>FM</sub> <sup>[1]</sup>	100	mA
Thermal Resistance (Junction / Ambient)	R <sub>th JA</sub> <sup>[2]</sup>	100	°C/W
Thermal Resistance (Junction / Solder point)	R <sub>th JS</sub> <sup>[2]</sup>	50	°C/W

## Notes:

1. 1/10 Duty Cycle, 0.1ms Pulse Width.

2. R<sub>th JA</sub>, R<sub>th JS</sub> Results from mounting on PC board FR4 (pad size  $\geq 16 \text{ mm}^2$  per pad).

3. Relative humidity levels maintained between 40% and 60% in production area are recommended to avoid the build-up of static electricity – Ref JEDEC/JESD625-A and JEDEC/J-STD-033.

### TECHNICAL DATA

#### RELATIVE INTENSITY vs. WAVELENGTH

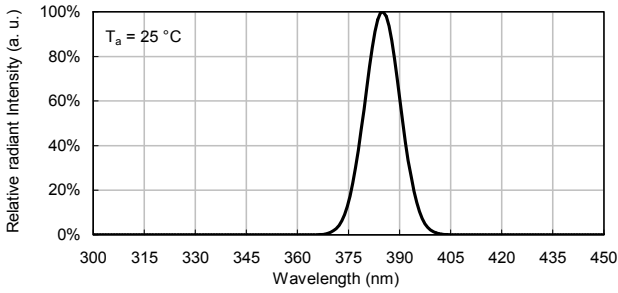

#### SPATIAL DISTRIBUTION

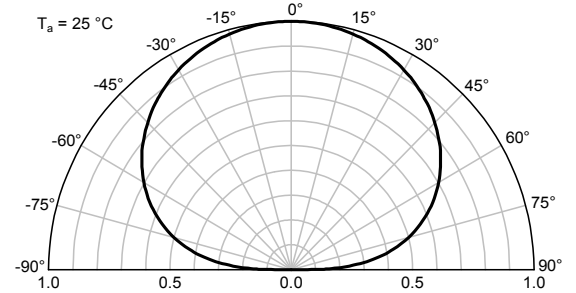

### ULTRAVIOLET

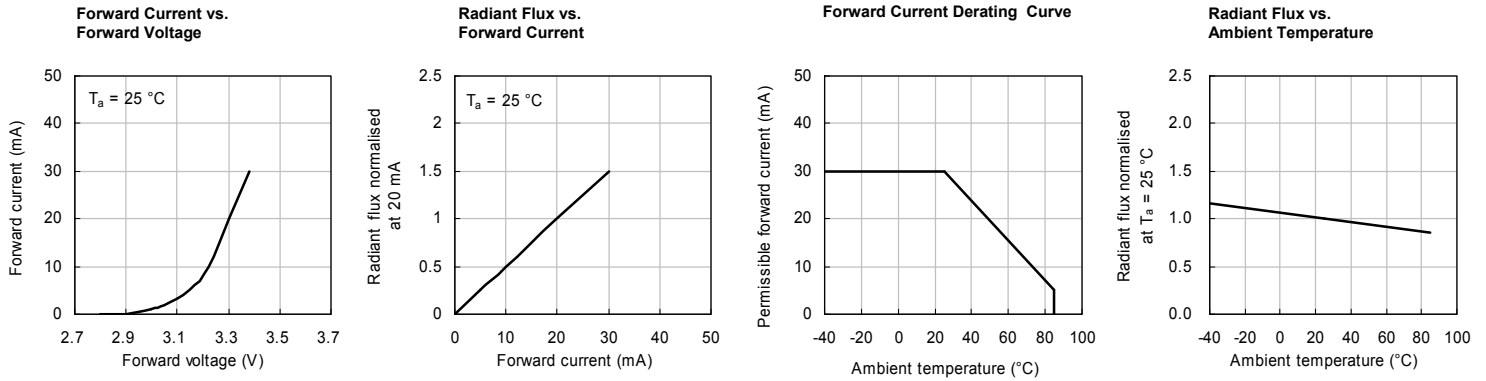

#### REFLOW SOLDERING PROFILE for LEAD-FREE SMD PROCESS

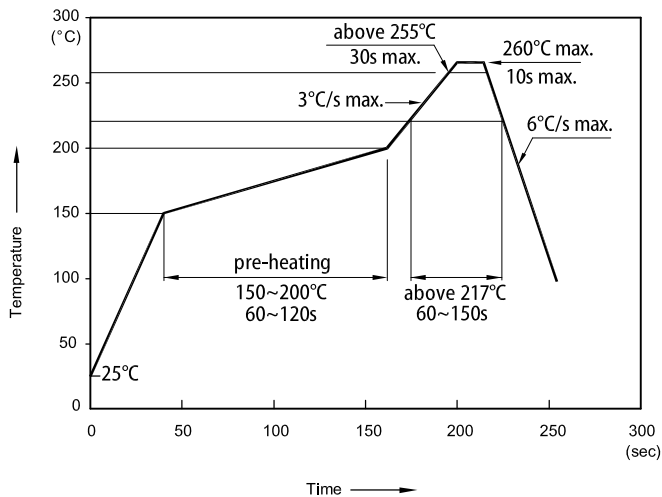

- Notes:
1. Don't cause stress to the LEDs while it is exposed to high temperature.
  2. The maximum number of reflow soldering passes is 2 times.
  3. Reflow soldering is recommended. Other soldering methods are not recommended as they might cause damage to the product.

#### TAPE SPECIFICATIONS (units : mm)

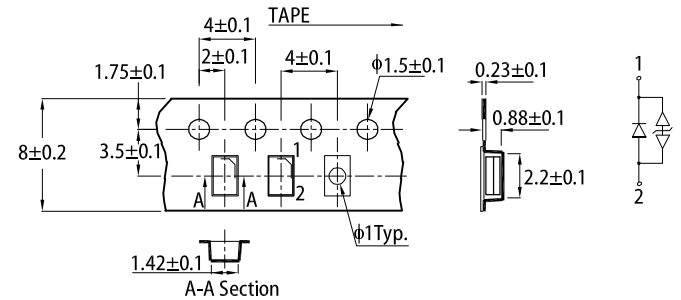

#### REEL DIMENSION (units : mm)

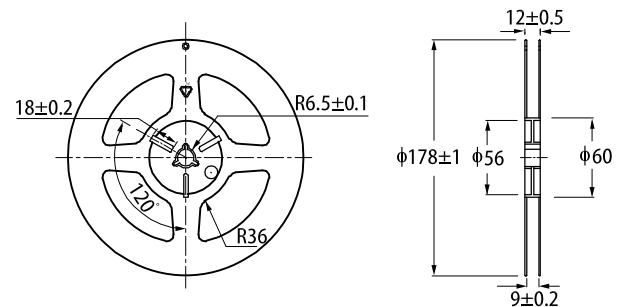

## PACKING & LABEL SPECIFICATIONS

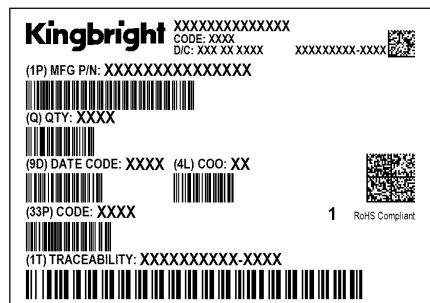
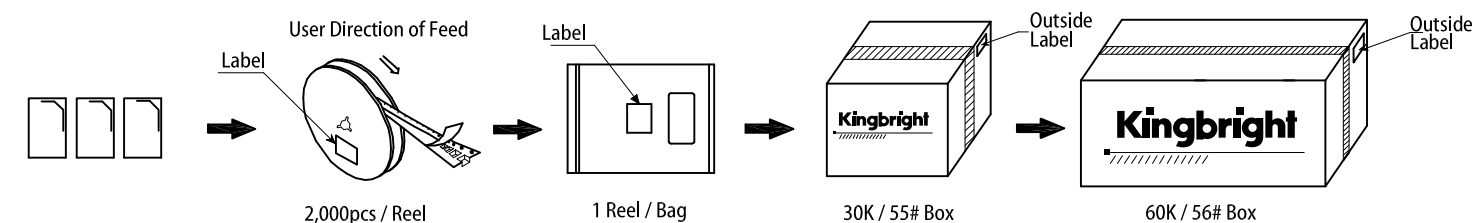

## HANDLING PRECAUTIONS

Compare to epoxy encapsulant that is hard and brittle, silicone is softer and flexible. Although its characteristic significantly reduces thermal stress, it is more susceptible to damage by external mechanical force. As a result, special handling precautions need to be observed during assembly using silicone encapsulated LED products. Failure to comply might lead to damage and premature failure of the LED.

1. Handle the component along the side surfaces by using forceps or appropriate tools.
2. Do not directly touch or handle the silicone lens surface. It may damage the internal circuitry.
3. Do not stack together assembled PCBs containing exposed LEDs. Impact may scratch the silicone lens

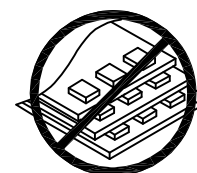
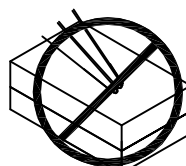
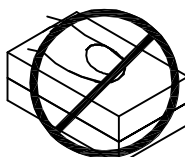
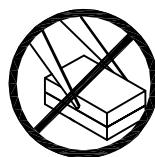
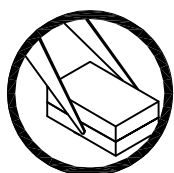

4. As silicone encapsulation is permeable to gases, some corrosive substances such as H<sub>2</sub>S might corrode silver plating of lead frame. Special care should be taken if an LED with silicone encapsulation is to be used near such substances.

## PRECAUTIONARY NOTES

1. The information included in this document reflects representative usage scenarios and is intended for technical reference only.
2. The part number, type, and specifications mentioned in this document are subject to future change and improvement without notice. Before production usage customer should refer to the latest datasheet for the updated specifications.
3. When using the products referenced in this document, please make sure the product is being operated within the environmental and electrical limits specified in the datasheet. If customer usage exceeds the specified limits, Kingbright will not be responsible for any subsequent issues.
4. The information in this document applies to typical usage in consumer electronics applications. If customer's application has special reliability requirements or have life-threatening liabilities, such as automotive or medical usage, please consult with Kingbright representative for further assistance.
5. The contents and information of this document may not be reproduced or re-transmitted without permission by Kingbright.
6. All design applications should refer to Kingbright application notes available at <http://www.KingbrightUSA.com/ApplicationNotes>