



Chipsmall Limited consists of a professional team with an average of over 10 year of expertise in the distribution of electronic components. Based in Hongkong, we have already established firm and mutual-benefit business relationships with customers from,Europe,America and south Asia,supplying obsolete and hard-to-find components to meet their specific needs.

With the principle of “Quality Parts,Customers Priority,Honest Operation,and Considerate Service”,our business mainly focus on the distribution of electronic components. Line cards we deal with include Microchip,ALPS,ROHM,Xilinx,Pulse,ON,Everlight and Freescale. Main products comprise IC,Modules,Potentiometer,IC Socket,Relay,Connector.Our parts cover such applications as commercial,industrial, and automotives areas.

We are looking forward to setting up business relationship with you and hope to provide you with the best service and solution. Let us make a better world for our industry!



Contact us

Tel: +86-755-8981 8866 Fax: +86-755-8427 6832

Email & Skype: info@chipsmall.com Web: www.chipsmall.com

Address: A1208, Overseas Decoration Building, #122 Zhenhua RD., Futian, Shenzhen, China



INSULATED GATE BIPOLAR TRANSISTOR WITH ULTRAFAST SOFT RECOVERY DIODE
Features

- Low $V_{CE(on)}$ Trench IGBT Technology
- Low Switching Losses
- 6 μ s SCSOA
- Square RBSOA
- 100% of the parts tested for I_{LM} ①
- Positive $V_{CE(on)}$ Temperature Coefficient
- Soft Recovery Co-pak Diode
- Lead-Free, RoHS Compliant
- Automotive Qualified *

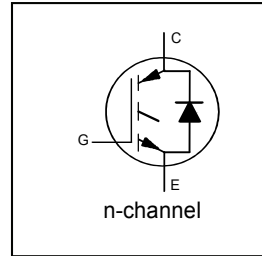

$V_{CES} = 600V$
 $I_C = 160A, T_C = 100^\circ C$
 $t_{sc} \geq 6\mu s, T_{J(MAX)} = 175^\circ C$
 $V_{CE(on) typ.} = 1.70V$

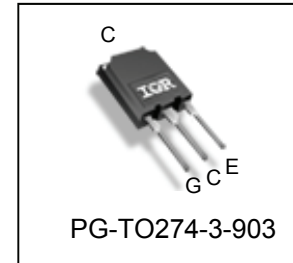

G	C	E
Gate	Collector	Emitter

Benefits

- High Efficiency in a Wide Range of Applications
- Suitable for Applications in the Low to Mid-Range Frequencies
- Rugged Transient Performance for Increased Reliability
- Excellent Current Sharing in Parallel Operation
- Low EMI

Base Part Number	Package Type	Standard Pack		Orderable Part Number
		Form	Quantity	
AUIRGPS4067D1	PG-TO274-3-903	Tube	25	AUIRGPS4067D1

Absolute Maximum Ratings

Stresses beyond those listed under "Absolute Maximum Ratings" may cause permanent damage to the device. These are stress ratings only; and functional operation of the device at these or any other condition beyond those indicated in the specifications is not implied. Exposure to absolute-maximum-rated conditions for extended periods may affect device reliability. The thermal resistance and power dissipation ratings are measured under board mounted and still air conditions. Ambient temperature (T_A) is 25°C, unless otherwise specified.

	Parameter	Max.	Units
V_{CES}	Collector-to-Emitter Voltage	600	V
$I_C @ T_C = 25^\circ C$	Continuous Collector Current	240⑤	A
$I_C @ T_C = 100^\circ C$	Continuous Collector Current	160	
$I_{NOMINAL}$	Nominal Current	120	
I_{CM}	Pulse Collector Current, $V_{GE} = 15V$	360	
I_{LM}	Clamped Inductive Load Current, $V_{GE} = 20V$ ①	480	
$I_{F NOMINAL}$	Diode Nominal Current ②	120⑤	
I_{FM}	Diode Maximum Forward Current ②	480	
V_{GE}	Continuous Gate-to-Emitter Voltage	± 20	V
	Transient Gate-to-Emitter Voltage	± 30	
$P_D @ T_C = 25^\circ C$	Maximum Power Dissipation	750	W
$P_D @ T_C = 100^\circ C$	Maximum Power Dissipation	375	
T_J T_{STG}	Operating Junction and Storage Temperature Range	-55 to +175	°C
	Soldering Temperature, for 10 sec.	300 (0.063 in. (1.6mm) from case)	

Thermal Resistance

	Parameter	Typ.	Max.	Units
$R_{\theta JC}$ (IGBT)	Thermal Resistance Junction-to-Case (each IGBT) ④	—	0.20	°C/W
$R_{\theta JC}$ (Diode)	Thermal Resistance Junction-to-Case (each Diode) ④	—	0.44	
$R_{\theta CS}$	Thermal Resistance, Case-to-Sink (flat, greased surface)	0.24	—	
$R_{\theta JA}$	Thermal Resistance, Junction-to-Ambient (typical socket mount)	—	40	

* Qualification standards can be found at www.infineon.com

Electrical Characteristics @ T_J = 25°C (unless otherwise specified)

	Parameter	Min.	Typ.	Max.	Units	Conditions
V _{(BR)CES}	Collector-to-Emitter Breakdown Voltage	600	—	—	V	V _{GE} = 0V, I _C = 500μA ③
ΔV _{(BR)CES} /ΔT _J	Temperature Coeff. of Breakdown Voltage	—	0.27	—	V/°C	V _{GE} = 0V, I _C = 15mA (25°C-175°C)
V _{CE(on)}	Collector-to-Emitter Saturation Voltage	—	1.7	2.05	V	I _C = 120A, V _{GE} = 15V, T _J = 25°C
		—	2.15	—		I _C = 120A, V _{GE} = 15V, T _J = 150°C
		—	2.20	—		I _C = 120A, V _{GE} = 15V, T _J = 175°C
V _{GE(th)}	Gate Threshold Voltage	4.0	—	6.5	V	V _{CE} = V _{GE} , I _C = 5.6mA
ΔV _{GE(th)} /ΔT _J	Threshold Voltage temp. coefficient	—	-17	—	mV/°C	V _{CE} = V _{GE} , I _C = 20mA (25°C-175°C)
g _{fe}	Forward Transconductance	—	85	—	S	V _{CE} = 50V, I _C = 120A
I _{CES}	Collector-to-Emitter Leakage Current	—	2.3	200	μA	V _{GE} = 0V, V _{CE} = 600V
		—	9.4	—	mA	V _{GE} = 0V, V _{CE} = 600V, T _J = 175°C
V _{FM}	Diode Forward Voltage Drop	—	1.9	2.2	V	I _F = 120A
		—	2.0	—		I _F = 120A, T _J = 175°C
I _{GES}	Gate-to-Emitter Leakage Current	—	—	±100	nA	V _{GE} = ±20V

Switching Characteristics @ T_J = 25°C (unless otherwise specified)

	Parameter	Min.	Typ.	Max.	Units	Conditions
Q _g	Total Gate Charge (turn-on)	—	240	360	nC	I _C = 120A V _{GE} = 15V V _{CC} = 400V
Q _{ge}	Gate-to-Emitter Charge (turn-on)	—	69	104		
Q _{gc}	Gate-to-Collector Charge (turn-on)	—	90	135		
E _{on}	Turn-On Switching Loss	—	8.2	10	mJ	I _C = 120A, V _{CC} = 400V, V _{GE} = 15V R _G = 4.7Ω, L = 87μH, T _J = 25°C Energy losses include tail & diode reverse recovery
E _{off}	Turn-Off Switching Loss	—	2.9	3.2		
E _{total}	Total Switching Loss	—	11.1	13.2		
t _{d(on)}	Turn-On delay time	—	69	82	ns	I _C = 120A, V _{CC} = 400V, V _{GE} = 15V R _G = 4.7Ω, L = 87μH, T _J = 25°C Energy losses include tail & diode reverse recovery
t _r	Rise time	—	65	82		
t _{d(off)}	Turn-Off delay time	—	198	230		
t _f	Fall time	—	38	48		
E _{on}	Turn-On Switching Loss	—	10	—	mJ	I _C = 120A, V _{CC} = 400V, V _{GE} = 15V R _G = 4.7Ω, L = 87μH, T _J = 175°C Energy losses include tail & diode reverse recovery
E _{off}	Turn-Off Switching Loss	—	3.8	—		
E _{total}	Total Switching Loss	—	13.8	—		
t _{d(on)}	Turn-On delay time	—	63	—	ns	I _C = 120A, V _{CC} = 400V, V _{GE} = 15V R _G = 4.7Ω, L = 87μH, T _J = 175°C Energy losses include tail & diode reverse recovery
t _r	Rise time	—	64	—		
t _{d(off)}	Turn-Off delay time	—	230	—		
t _f	Fall time	—	51	—		
C _{ies}	Input Capacitance	—	7780	—	pF	V _{GE} = 0V V _{CC} = 30V f = 1.0Mhz
C _{oes}	Output Capacitance	—	505	—		
C _{res}	Reverse Transfer Capacitance	—	245	—		
RBSOA	Reverse Bias Safe Operating Area	FULL SQUARE				T _J = 175°C, I _C = 480A V _{CC} = 480V, V _p ≤ 600V R _G = 4.7Ω, V _{GE} = +20V to 0V
SCSOA	Short Circuit Safe Operating Area	6	—	—	μs	V _{CC} = 400V, V _p ≤ 600V R _G = 1.0Ω, V _{GE} = +15V to 0V
E _{rec}	Reverse Recovery Energy of the Diode	—	2440	—	μJ	T _J = 175°C
t _{rr}	Diode Reverse Recovery Time	—	360	—	ns	V _{CC} = 400V, I _F = 120A
I _{rr}	Peak Reverse Recovery Current	—	53	—	A	V _{GE} = 15V, R _G = 4.7Ω, L = 87μH

Notes:

- ① V_{CC} = 80% (V_{CES}), V_{GE} = 20V, L = 0.87μH, R_G = 50Ω tested in production ILM ≤ 400A.
- ② Pulse width limited by max. junction temperature.
- ③ Refer to AN-1086 for guidelines for measuring V_{(BR)CES} safely.
- ④ R_θ is measured at T_J approximately 90°C.
- ⑤ Calculated continuous current based on maximum allowable junction temperature. Package IGBT current limit is 195A. Package diode current limit is 120A. Note that current limitations arising from heating of the device leads may occur.

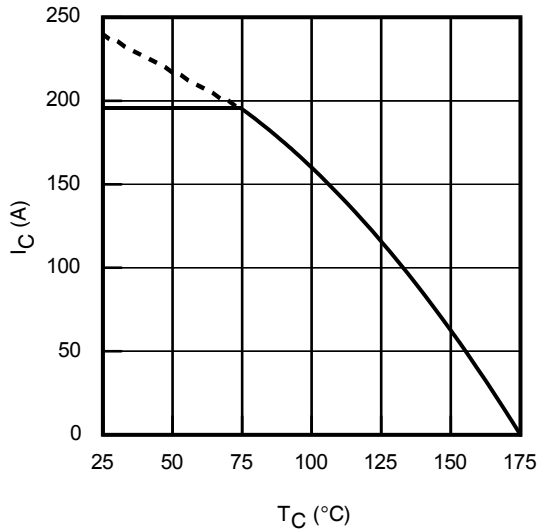

Fig. 1 - Maximum DC Collector Current vs. Case Temperature

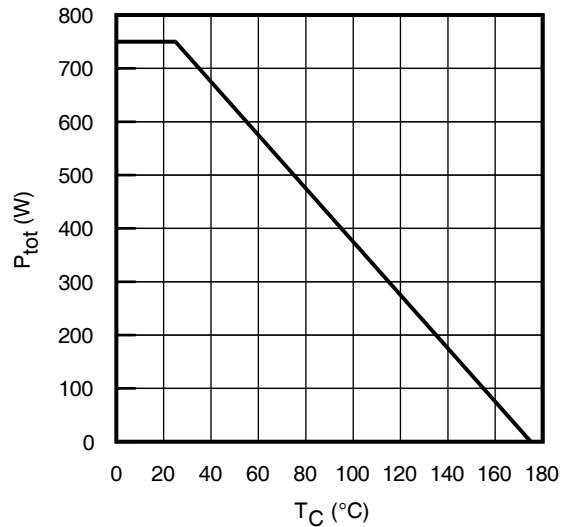

Fig. 2 - Power Dissipation vs. Case Temperature

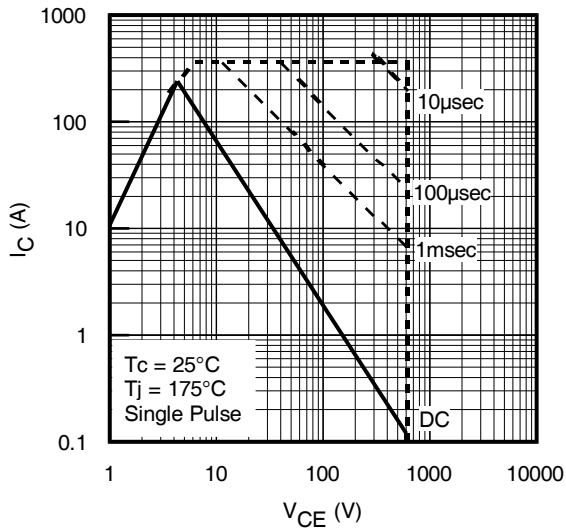

Fig. 3 - Forward SOA

$T_C = 25^\circ\text{C}$, $T_J \leq 175^\circ\text{C}$; $V_{GE} = 15\text{V}$

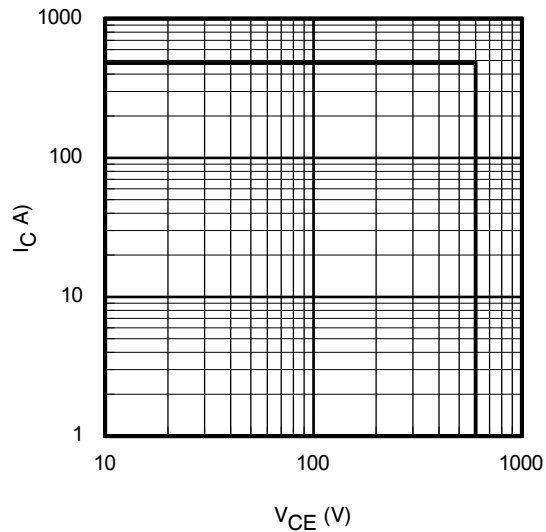

Fig. 4 - Reverse Bias SOA

$T_J = 175^\circ\text{C}$; $V_{GE} = 20\text{V}$

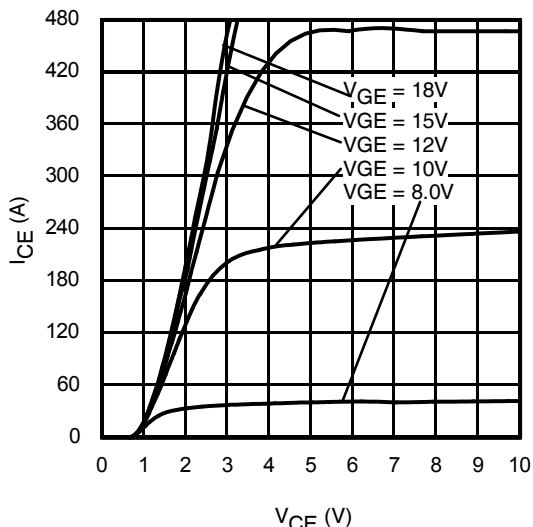

Fig. 5 - Typ. IGBT Output Characteristics
 $T_J = -40^\circ\text{C}$; $t_p = 30\mu\text{s}$

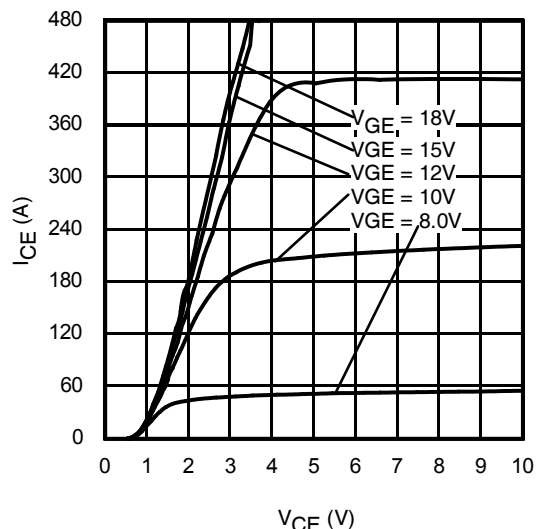

Fig. 6 - Typ. IGBT Output Characteristics
 $T_J = 25^\circ\text{C}$; $t_p = 30\mu\text{s}$

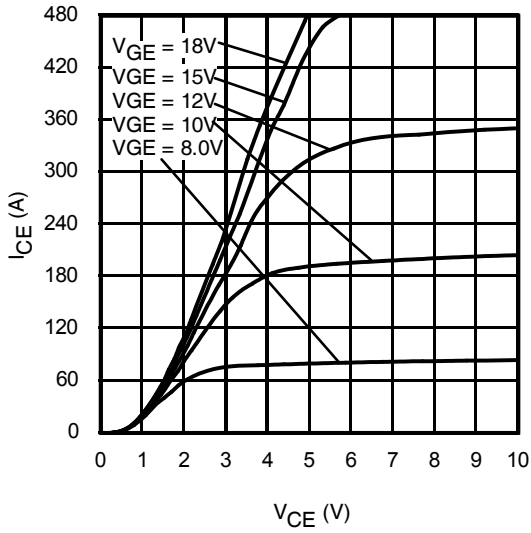

Fig. 7 - Typ. IGBT Output Characteristics
 $T_J = 175^\circ\text{C}$; $t_p = 30\mu\text{s}$

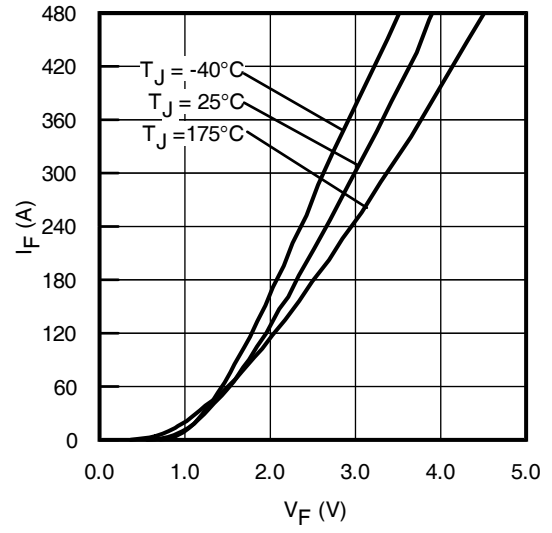

Fig. 8 - Typ. Diode Forward Characteristics
 $t_p = 30\mu\text{s}$

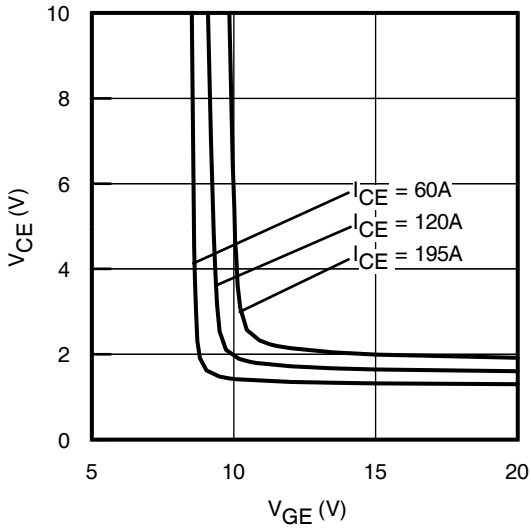

Fig. 9 - Typical V_{CE} vs. V_{GE}
 $T_J = -40^\circ\text{C}$

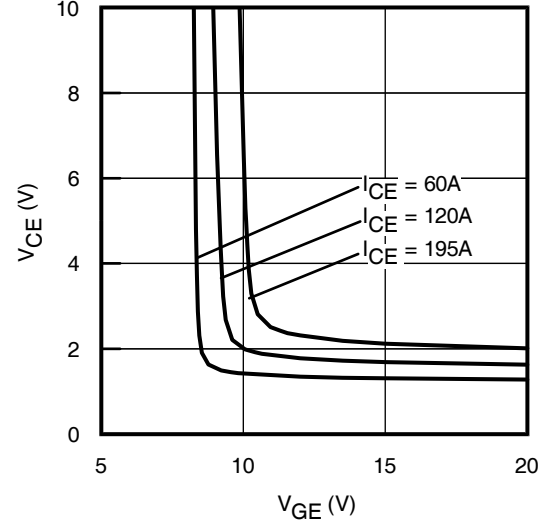

Fig. 10 - Typical V_{CE} vs. V_{GE}
 $T_J = 25^\circ\text{C}$

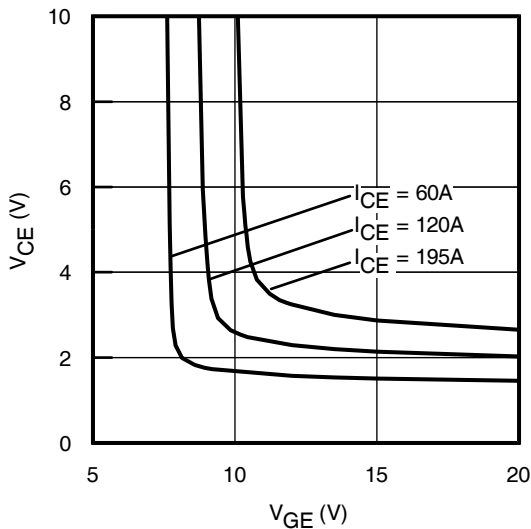

Fig. 11 - Typical V_{CE} vs. V_{GE}
 $T_J = 175^\circ\text{C}$

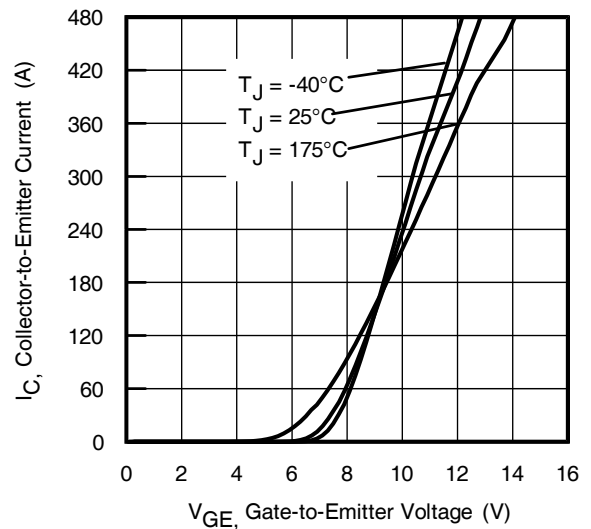
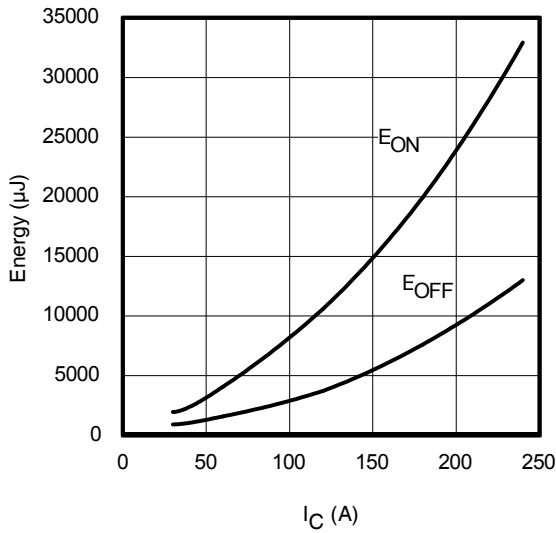
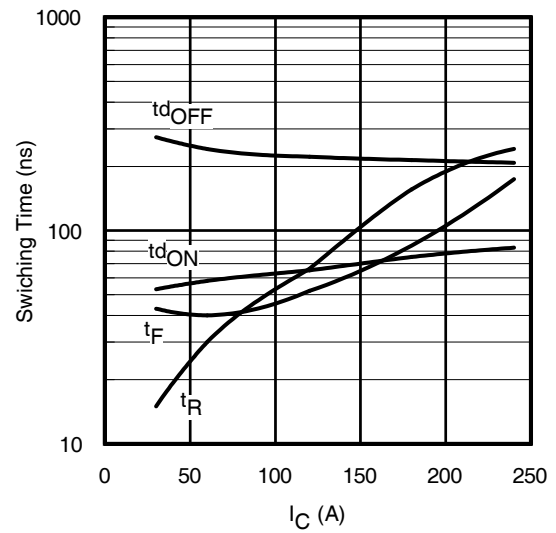
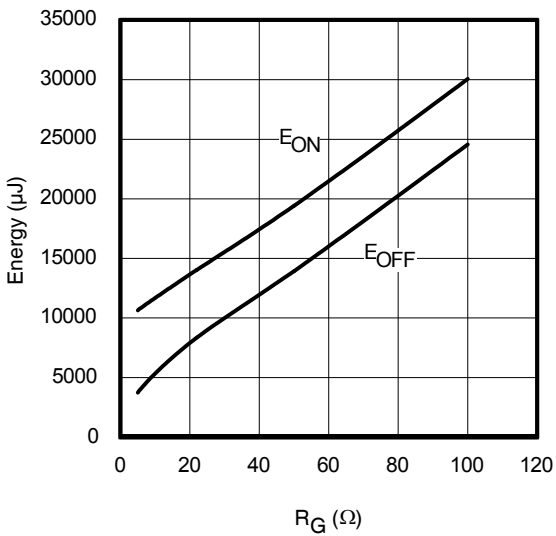
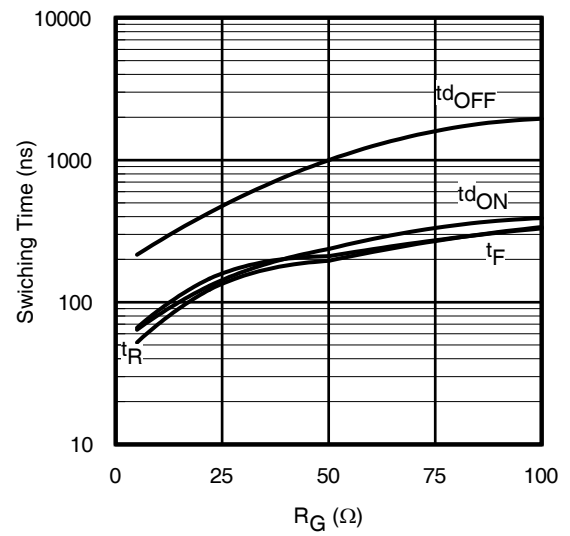
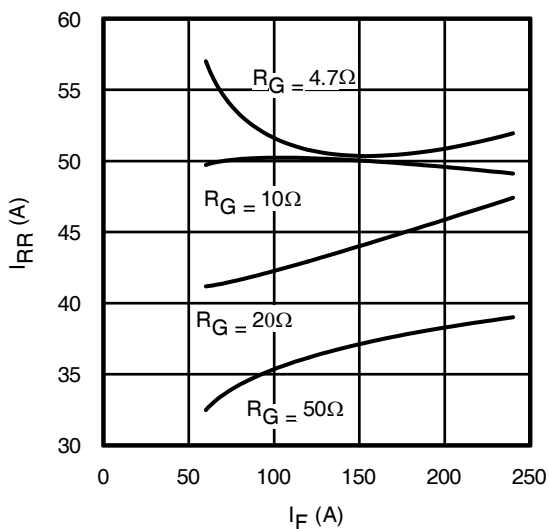
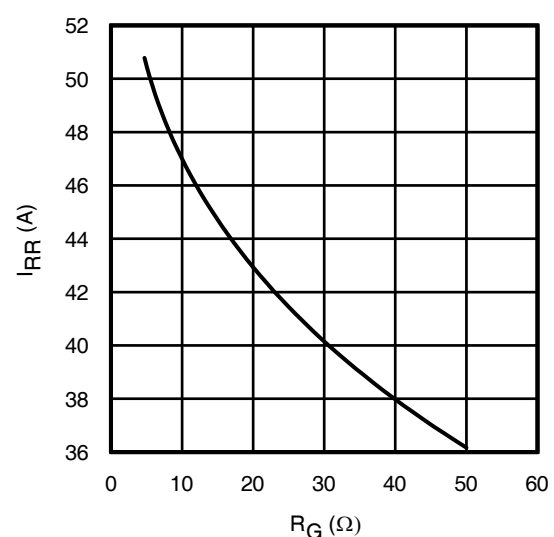

Fig. 12 - Typ. Transfer Characteristics
 $V_{CE} = 50\text{V}$; $t_p = 10\mu\text{s}$

Fig. 13 - Typ. Energy Loss vs. I_C
 $T_J = 175^\circ\text{C}; L = 0.087\text{mH}; V_{CE} = 400\text{V}, R_G = 5.0\Omega; V_{GE} = 15\text{V}$

Fig. 14 - Typ. Switching Loss vs. I_C
 $T_J = 175^\circ\text{C}; L = 0.087\text{mH}; V_{CE} = 400\text{V}, R_G = 5.0\Omega; V_{GE} = 15\text{V}$

Fig. 15 - Typ. Energy Loss vs. R_G
 $T_J = 175^\circ\text{C}; L = 0.087\text{mH}; V_{CE} = 400\text{V}, I_{CE} = 120\text{A}; V_{GE} = 15\text{V}$

Fig. 16 - Typ. Switching Time vs. R_G
 $T_J = 175^\circ\text{C}; L = 0.087\text{mH}; V_{CE} = 400\text{V}, I_{CE} = 120\text{A}; V_{GE} = 15\text{V}$

Fig. 17 - Typ. Diode I_{RR} vs. I_F
 $T_J = 175^\circ\text{C}$

Fig. 18 - Typ. Diode I_{RR} vs. R_G
 $T_J = 175^\circ\text{C}$

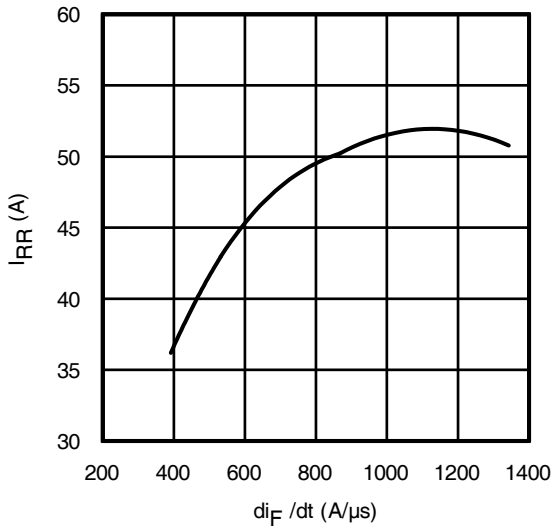

Fig. 19 - Typ. Diode I_{RR} vs. diF/dt
 $V_{CC} = 400V$; $V_{GE} = 15V$; $I_F = 120A$; $T_J = 175^\circ C$

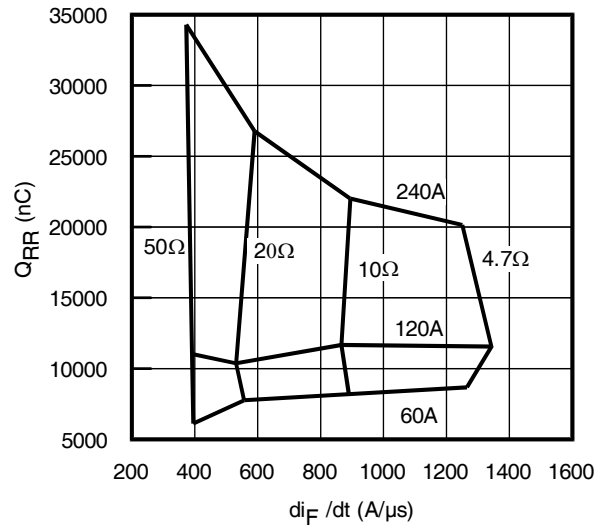

Fig. 20 - Typ. Diode Q_{RR} vs. diF/dt
 $V_{CC} = 400V$; $V_{GE} = 15V$; $T_J = 175^\circ C$

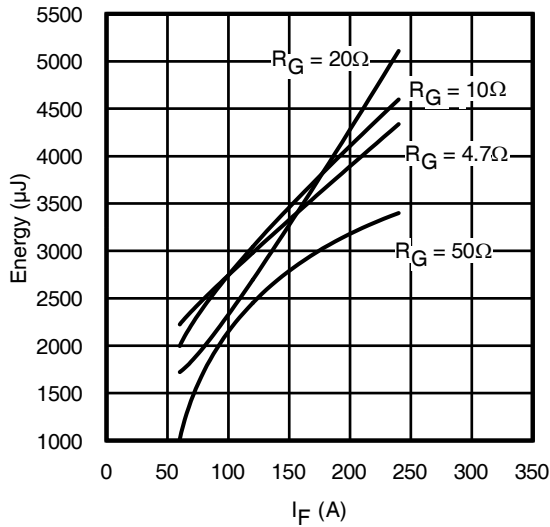

Fig. 21 - Typ. Diode E_{RR} vs. I_F
 $T_J = 175^\circ C$

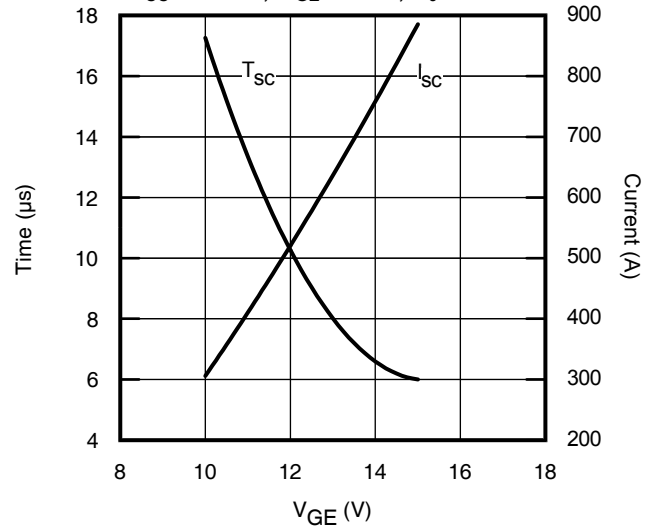

Fig. 22 - V_{GE} vs. Short Circuit Time
 $V_{CC} = 400V$; $T_C = 25^\circ C$

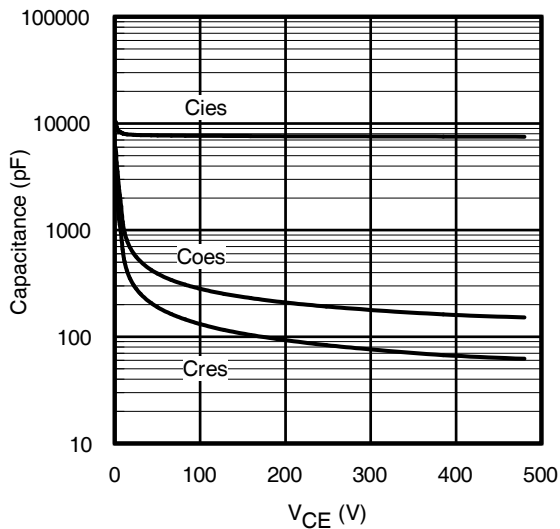

Fig. 23 - Typ. Capacitance vs. V_{CE}
 $V_{GE} = 0V$; $f = 1MHz$

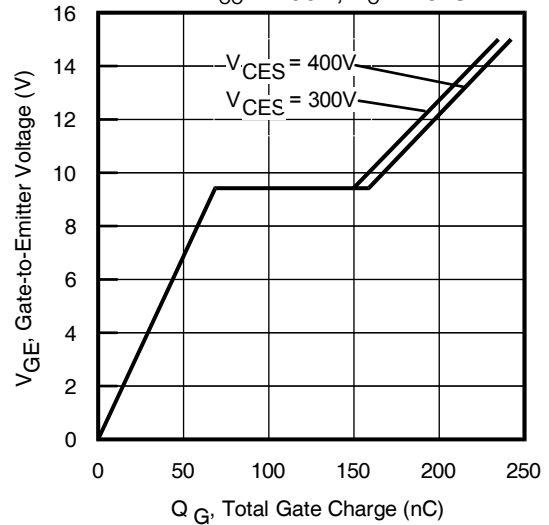
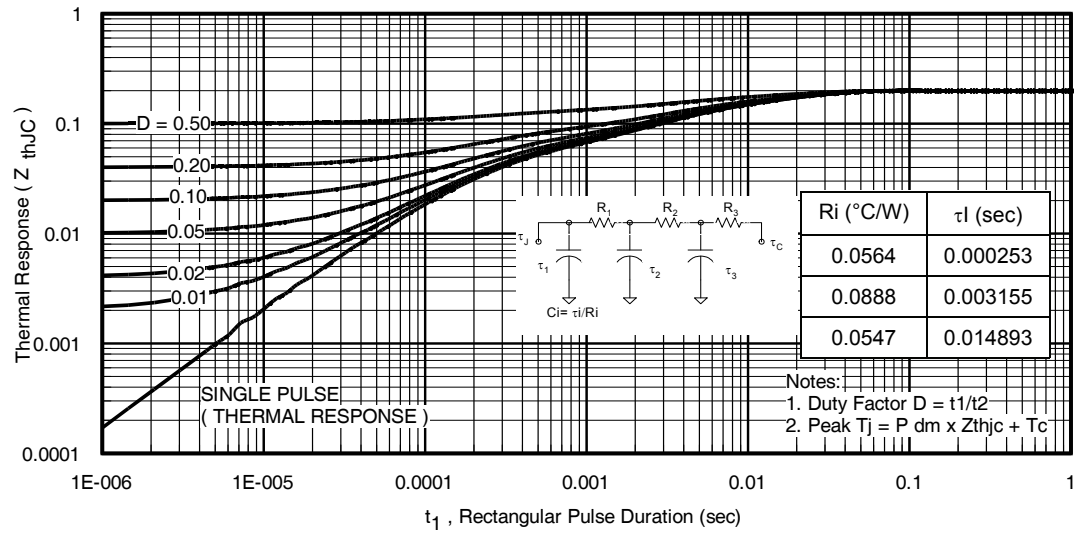
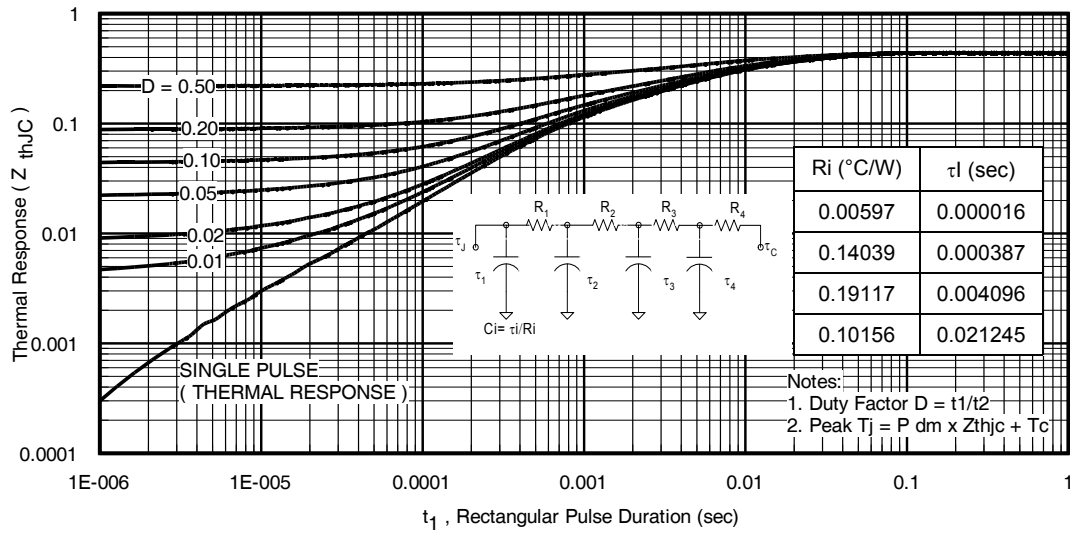
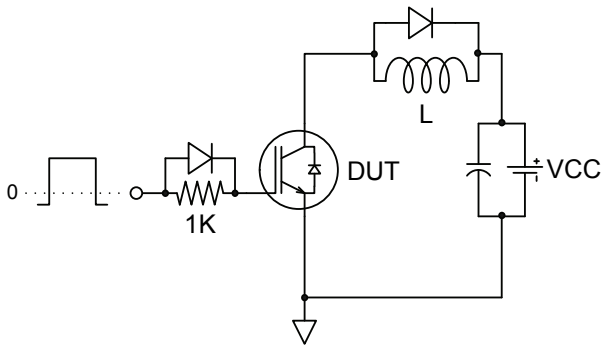

Fig. 24 - Typical Gate Charge vs. V_{GE}
 $I_{CE} = 120A$

Fig 25. Maximum Transient Thermal Impedance, Junction-to-Case (IGBT)

Fig 26. Maximum Transient Thermal Impedance, Junction-to-Case (DIODE)

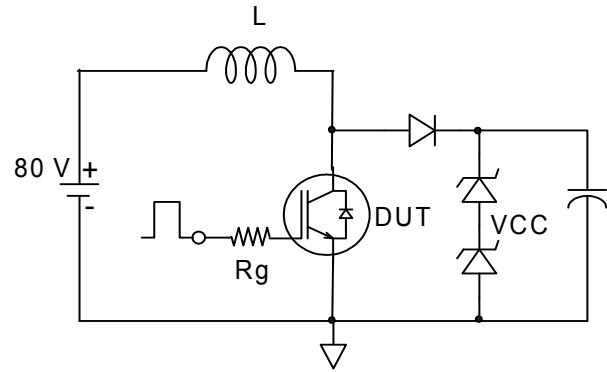

Gate Charge Circuit

Fig.C.T.1 - Gate Charge Circuit (turn-off)



RBSOA Circuit

Fig.C.T.2 - RBSOA Circuit

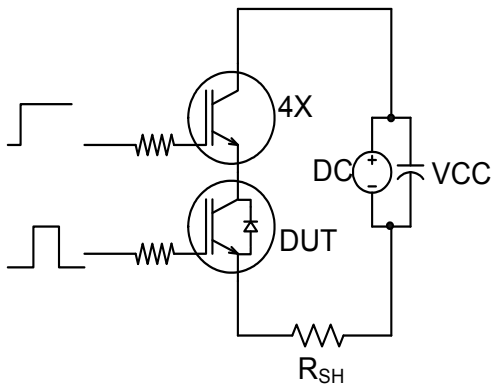
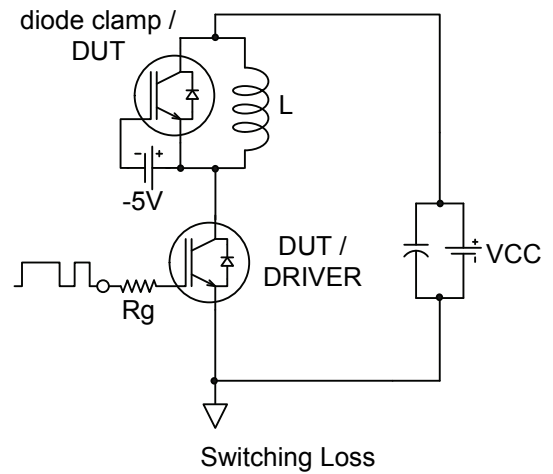

Fig.C.T.3 - S.C. SOA Circuit



Switching Loss

Fig.C.T.4 - Switching Loss Circuit

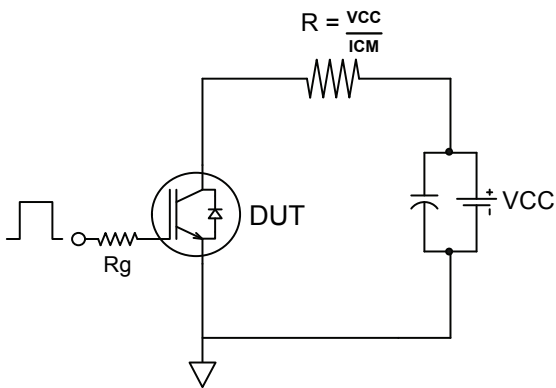

Fig.C.T.5 - Resistive Load Circuit

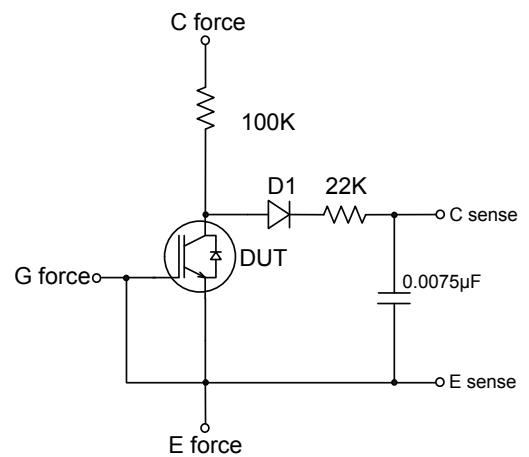

Fig.C.T.6 - BVCEs Filter Circuit

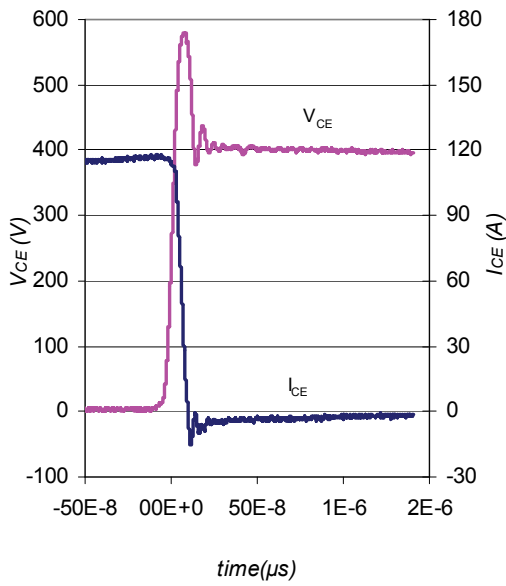

Fig. WF1 - Typ. Turn-off Loss Waveform
@ $T_J = 175^\circ\text{C}$ using Fig. CT.4

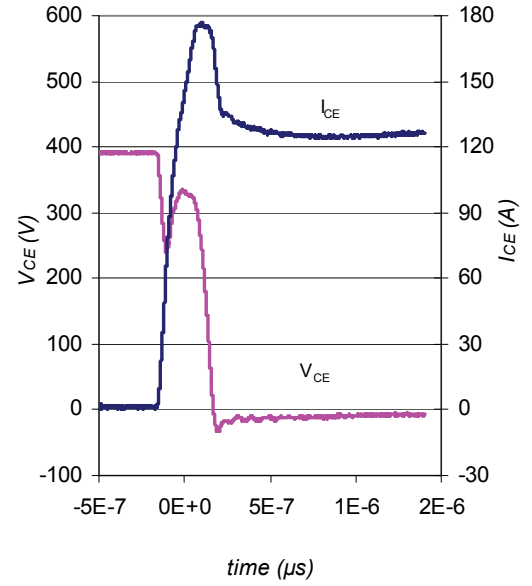

Fig. WF2 - Typ. Turn-on Loss Waveform
@ $T_J = 175^\circ\text{C}$ using Fig. CT.4

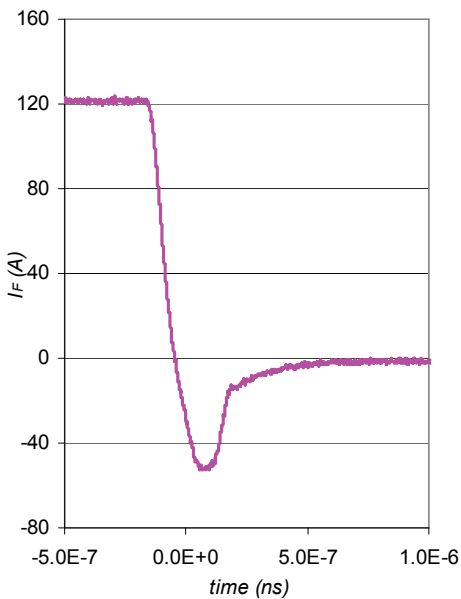

Fig. WF3 - Typ. Diode Recovery Waveform
@ $T_J = 175^\circ\text{C}$ using Fig. CT.4

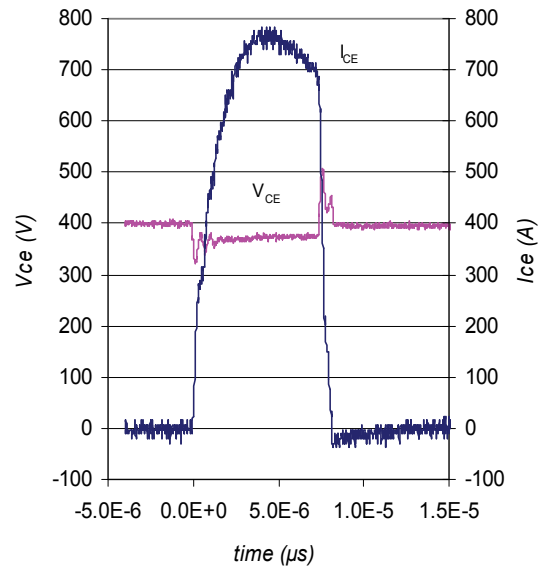

Fig. WF4 - Typ. S.C. Waveform
@ $T_J = 25^\circ\text{C}$ using Fig. CT.3

Qualification Information

Qualification Level	Automotive (per AEC-Q101)	
	This part number(s) passed Automotive qualification. Infineon's Industrial and Consumer qualification level is granted by extension of the higher Automotive level.	
Moisture Sensitivity Level	PG-TO274-3-903	N/A
ESD	Machine Model	Class M4(+/- 400) [†] AEC-Q101-002
	Human Body Model	Class H3B(+/- 8000) [†] AEC-Q101-001
	Charged Device Model	Class C5 (+/- 1000) [†] AEC-Q101-005
RoHS Compliant	Yes	

† Highest passing voltage.

Revision History

Date	Comments
07/19/2018	<ul style="list-style-type: none"> Updated datasheet with corporate template. Corrected the reference of "SUPER-247" to "PG-TO274-3-903" to align with IFX nomenclature on pages 1,10,11.

Published by

Infineon Technologies AG
81726 München, Germany

© Infineon Technologies AG 2015

All Rights Reserved.

IMPORTANT NOTICE

The information given in this document shall in no event be regarded as a guarantee of conditions or characteristics ("Beschaffenheitsgarantie"). With respect to any examples, hints or any typical values stated herein and/or any information regarding the application of the product, Infineon Technologies hereby disclaims any and all warranties and liabilities of any kind, including without limitation warranties of non-infringement of intellectual property rights of any third party.

In addition, any information given in this document is subject to customer's compliance with its obligations stated in this document and any applicable legal requirements, norms and standards concerning customer's products and any use of the product of Infineon Technologies in customer's applications.

The data contained in this document is exclusively intended for technically trained staff. It is the responsibility of customer's technical departments to evaluate the suitability of the product for the intended application and the completeness of the product information given in this document with respect to such application.

For further information on the product, technology, delivery terms and conditions and prices please contact your nearest Infineon Technologies office (www.infineon.com).

WARNINGS

Due to technical requirements products may contain dangerous substances. For information on the types in question please contact your nearest Infineon Technologies office.

Except as otherwise explicitly approved by Infineon Technologies in a written document signed by authorized representatives of Infineon Technologies, Infineon Technologies' products may not be used in any applications where a failure of the product or any consequences of the use thereof can reasonably be expected to result in personal injury.