



Chipsmall Limited consists of a professional team with an average of over 10 year of expertise in the distribution of electronic components. Based in Hongkong, we have already established firm and mutual-benefit business relationships with customers from,Europe,America and south Asia,supplying obsolete and hard-to-find components to meet their specific needs.

With the principle of “Quality Parts,Customers Priority,Honest Operation,and Considerate Service”,our business mainly focus on the distribution of electronic components. Line cards we deal with include Microchip,ALPS,ROHM,Xilinx,Pulse,ON,Everlight and Freescale. Main products comprise IC,Modules,Potentiometer,IC Socket,Relay,Connector.Our parts cover such applications as commercial,industrial, and automotives areas.

We are looking forward to setting up business relationship with you and hope to provide you with the best service and solution. Let us make a better world for our industry!



Contact us

Tel: +86-755-8981 8866 Fax: +86-755-8427 6832

Email & Skype: info@chipsmall.com Web: www.chipsmall.com

Address: A1208, Overseas Decoration Building, #122 Zhenhua RD., Futian, Shenzhen, China



AVT-52663
 DC – 6000 MHz
 InGaP HBT Gain Block



Data Sheet

Description

Avago Technologies' AVT-52663 is an economical, easy-to-use, general purpose InGaP HBT MMIC gain block amplifier utilizing Darlington pair configuration housed in a 6-lead (SOT-363) surface mount plastic package.

The Darlington feedback structure provides inherent broad bandwidth performance, resulting in useful operating frequency up to 6 GHz. This is an ideal device for small-signal gain cascades or IF amplification.

AVT-52263 is fabricated using advanced InGaP HBT (Hetero-junction Bipolar Transistor) technology that offers state-of-the-art reliability, temperature stability and performance consistency.

Component Image

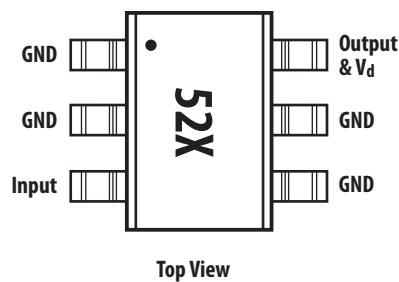

Notes:
 Package marking provides orientation and identification
 "52" = Device Code
 "X" = Month of Manufacture
 "•" = Pin 1



Attention: Observe precautions for handling electrostatic sensitive devices.
 ESD Machine Model (120V)
 ESD Human Body Model (1200V)
 Refer to Avago Application Note A004R:
 Electrostatic Discharge, Damage and Control.

Features

- Small signal gain amplifier
- Operating frequency DC to 6 GHz
- Unconditionally stable
- 50 Ohm input & output
- Flat, Broadband Frequency Response up to 2 GHz
- Industry standard SOT-363
- Lead-free, RoHS compliant, Green

Specifications

2 GHz, 5V Vcc, 45 mA (typical)

- 15.3 dB Gain
- 12.7 dBm P1dB
- 27 dBm OIP3
- 4 dB NF
- 15 dB IRL and ORL

Applications

- Cellular / PCS / 3G base station
- Wireless Data / WLAN
- WiMAX / WiBRO
- CATV & Cable modem
- ISM

Typical Biasing Configuration

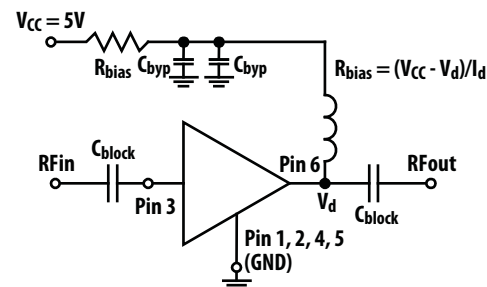

Absolute Maximum Rating^[1] $T_A=25^\circ\text{C}$

Symbol	Parameter	Units	Absolute Max.
I_d	Device Current	mA	90
$P_{IN,MAX}$	CW RF Input Power	dBm	18
P_{DISS}	Total Power Dissipation ^[3]	mW	394
T_{OPT}	Operating Temperature	$^\circ\text{C}$	-40 to 85
$T_{J,MAX}$	Junction Temperature	$^\circ\text{C}$	150
T_{STG}	Storage Temperature	$^\circ\text{C}$	-65 to 150

Thermal Resistance

Thermal Resistance^[2] $\theta_{JC} = 149^\circ\text{C/W}$
 $(I_d = 45 \text{ mA}, T_C = 85^\circ\text{C})$

Notes:

1. Operation of this device in excess of any of these limits may cause permanent damage.
2. Thermal resistance measured using Infrared measurement technique.
3. Ground lead temperature is 25°C . Derate $6.7\text{mW}/^\circ\text{C}$ for $T_C > 91^\circ\text{C}$.

Electrical Specifications^[4]

$T_A = 25^\circ\text{C}$, $Z_o = 50 \Omega$, $V_{CC} = 5 \text{ V}$, $R_{bias} = 22 \Omega$, $P_{in} = -15 \text{ dBm}$ (unless specified otherwise)

Symbol	Parameter and Test Condition	Frequency	Units	Min.	Typ.	Max.
I_d	Device Current		mA	42	45.6	49
G_p	Power Gain	900 MHz 2000 MHz	dB	13.8	16.1 15.5	16.8
ΔG_p	Gain Flatness	0.05 - 2 GHz			0.67	
f_{3dB}	3 dB Bandwidth		GHz		5	
OIP3 ^[5]	Output 3 rd Intercept Point	900 MHz 2000 MHz	dBm	26.2	30.2 27.7	
S11	Input Return Loss, 50Ω source	900 MHz 2000 MHz	dB		-21.9 -15.9	
S22	Output Return Loss, 50Ω load	900MHz 2000 MHz	dB		-19.1 -15.2	
S12	Reverse Isolation	900 MHz 2000 MHz	dB		-19.3 -19.8	
P1dB	Output Power at 1dB Gain Compression	900 MHz 2000 MHz	dBm		15.6 15	
NF	Noise Figure	900 MHz 2000 MHz	dB		3.6 4	

Notes:

4. Measurements obtained on CPWG line with reference plane at the ends of DUT leads (as shown in Figure 1).
5. OIP3 test condition: $F_{RF1} - F_{RF2} = 10\text{MHz}$ with input power of -15 dBm per tone measured at worse side band.

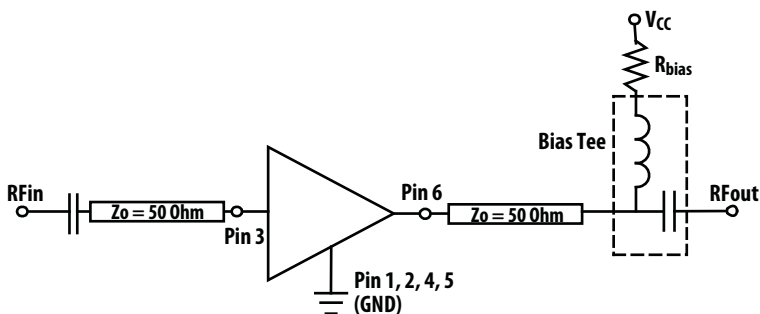

Figure 1. Block diagram of board used for I_d , Gain, OIP3, S11, S22, S12, OP1dB and NF measurements. Circuit losses have been de-embedded from actual measurements.

Product Consistency Distribution Charts at 2 GHz, $V_{CC} = 5\text{ V}$, $R_{bias} = 22\ \Omega$

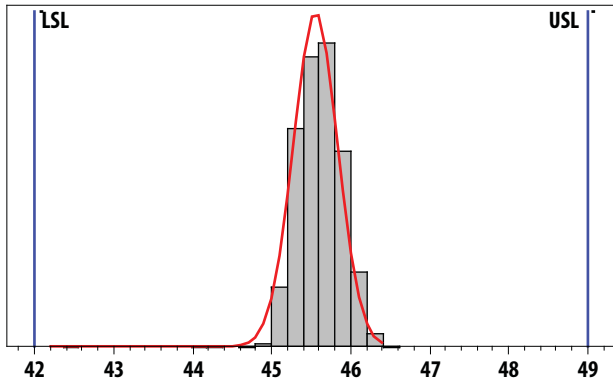

Figure 2. I_d (mA) distribution. LSL = 42, Nominal = 45.6, USL = 49

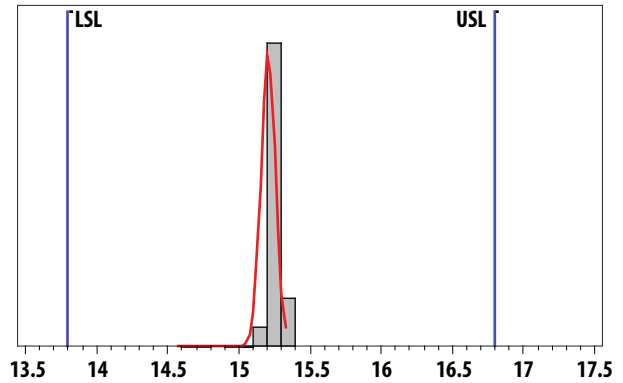

Figure 3. Gain (dB) distribution. LSL = 13.8, Nominal = 15.2, USL = 16.8

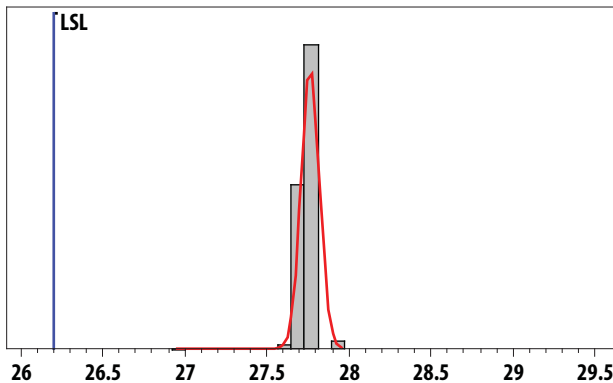

Figure 4. OIP3 (dBm) distribution. LSL = 26.2, Nominal = 27.7

Notes:

1. Statistical distribution determined from a sample size of 2099 samples taken from 6 different wafers, measured on a production test board.
2. Future wafers allocated to this product may have typical values anywhere between the minimum and maximum specification limits.

AVT-52663 Typical Performance Curves

$T_A = 25^\circ\text{C}$, $Z_o = 50\ \Omega$, $P_{in} = -15\ \text{dBm}$ (unless specified otherwise)

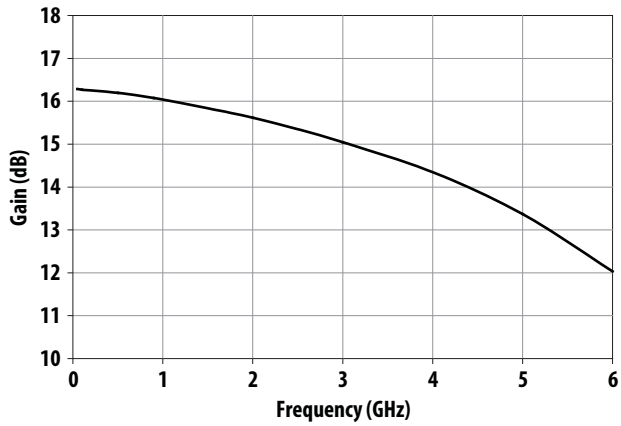

Figure 5. Gain vs Frequency at $I_d = 45\text{mA}$

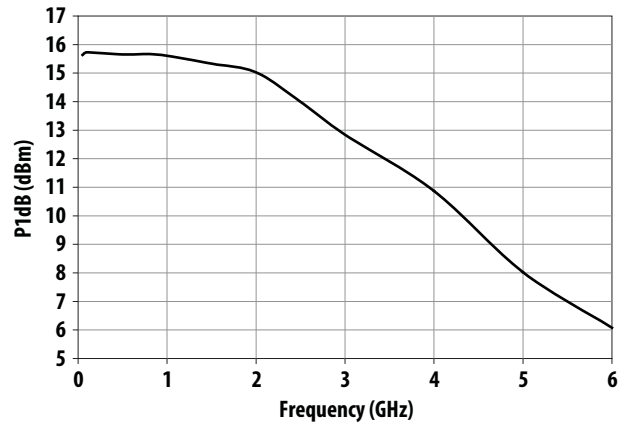

Figure 6. P1dB vs Frequency at $I_d = 45\text{mA}$

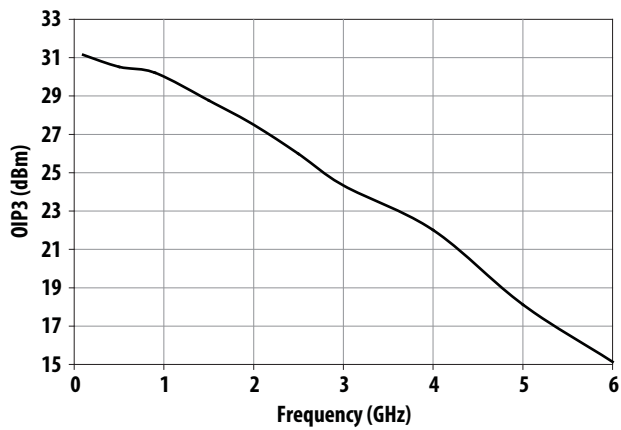

Figure 7. OIP3 vs Frequency at $I_d = 45\text{mA}$

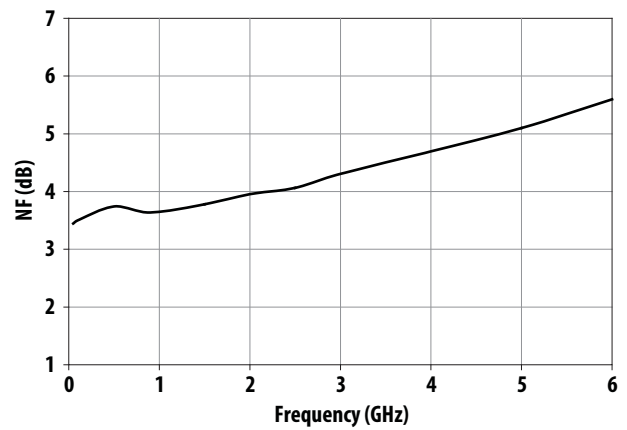

Figure 8. NF vs Frequency at $I_d = 45\text{mA}$

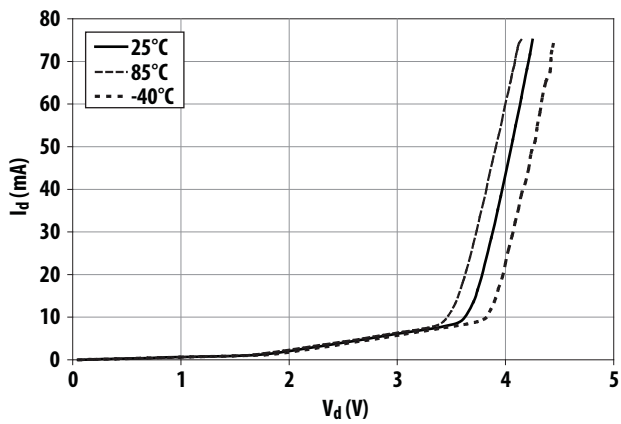

Figure 9. I_d vs V_d and Temperature

AVT-52663 Typical Performance Curves

$T_A = 25^\circ\text{C}$, $Z_o = 50 \Omega$, $P_{in} = -15 \text{ dBm}$ (unless specified otherwise), continued

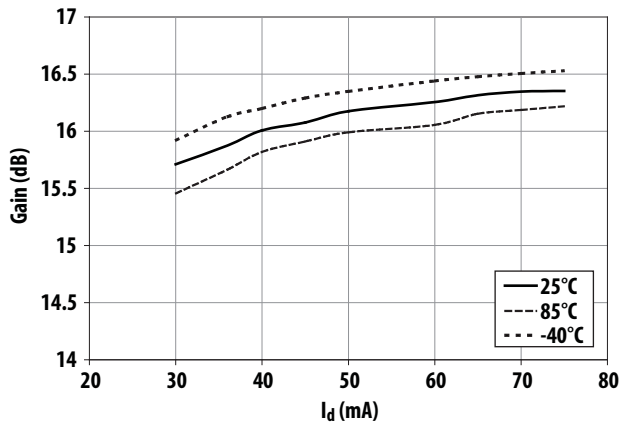

Figure 10. Gain vs I_d and Temperature at 900 MHz

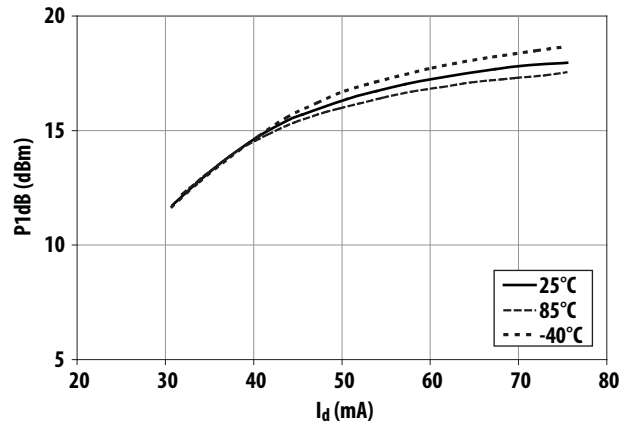

Figure 11. P1dB vs I_d and Temperature at 900 MHz

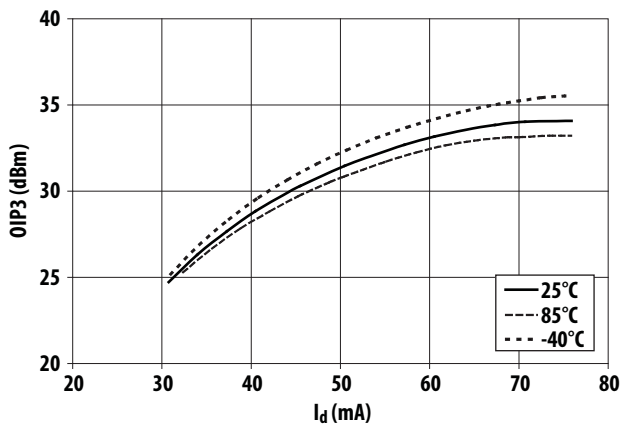

Figure 12. OIP3 vs I_d and Temperature at 900 MHz

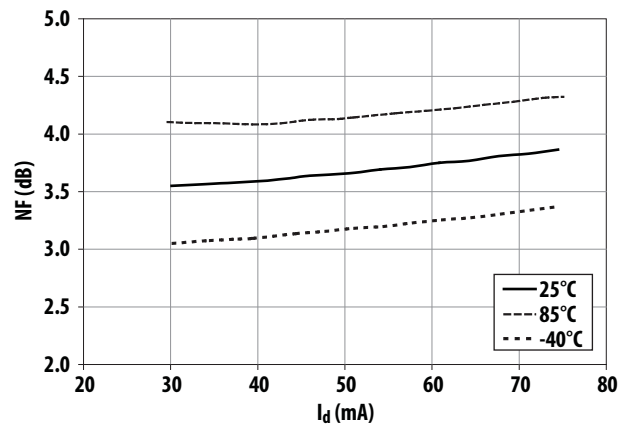

Figure 13. NF vs I_d and Temperature at 900 MHz

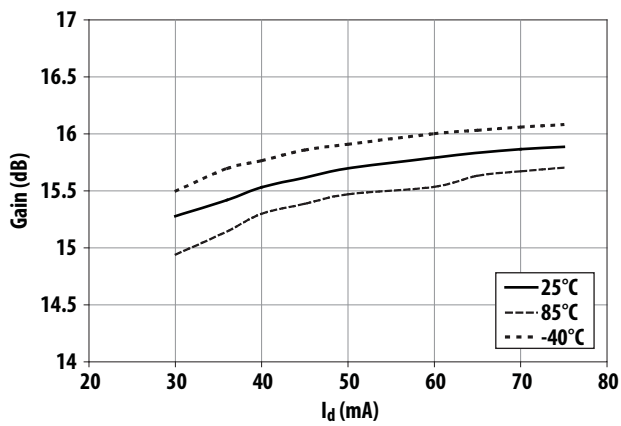

Figure 14. Gain vs I_d and Temperature at 2 GHz

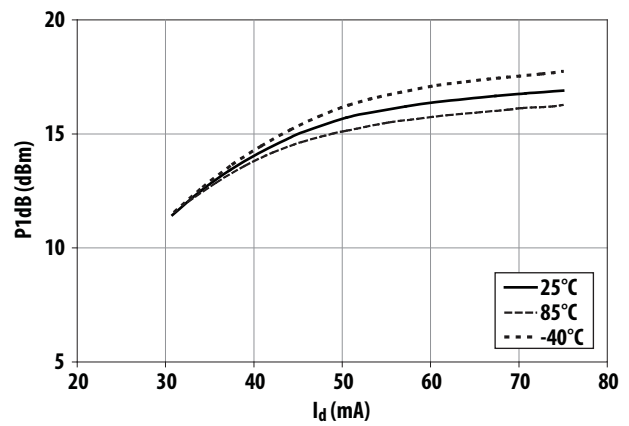

Figure 15. P1dB vs I_d and Temperature at 2 GHz

AVT-52663 Typical Performance Curves

$T_A = 25^\circ\text{C}$, $Z_o = 50 \Omega$, $P_{in} = -15 \text{ dBm}$ (unless specified otherwise), continued

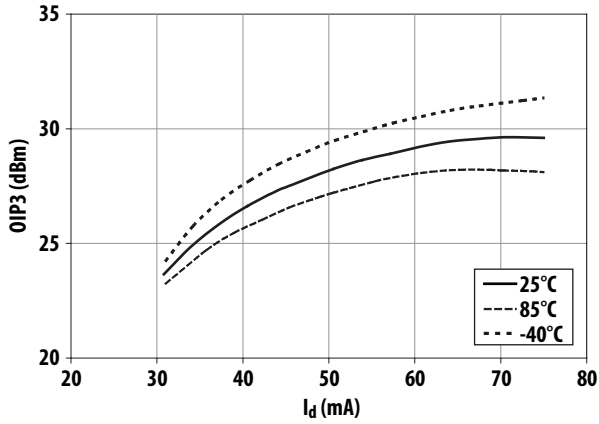

Figure 16. OIP3 vs I_d and Temperature at 2 GHz

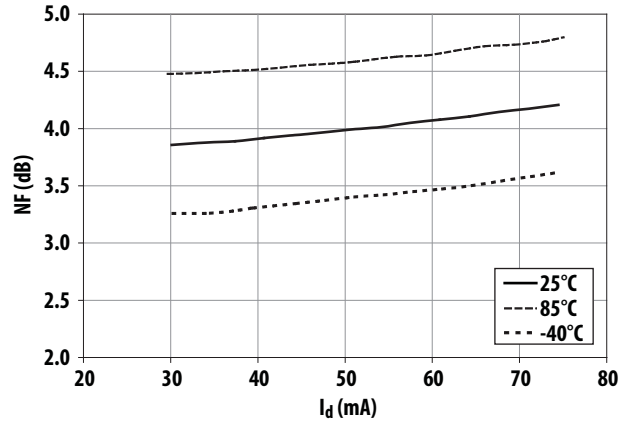

Figure 17. NF vs I_d and Temperature at 2 GHz

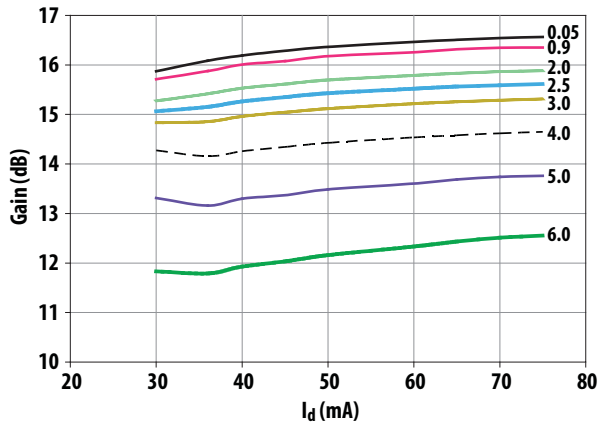

Figure 18. Gain vs I_d and Frequency (GHz)

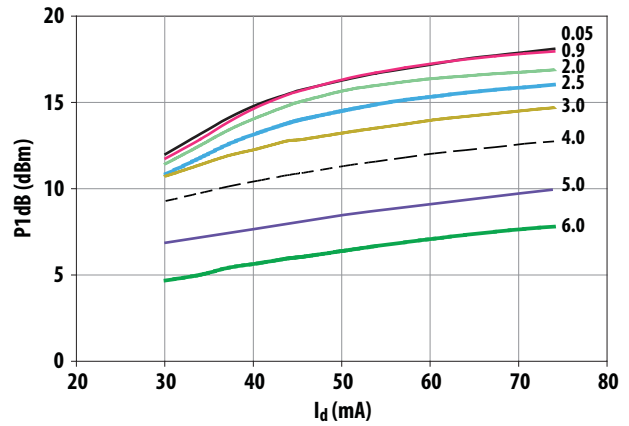

Figure 19. P1dB vs I_d and Frequency (GHz)

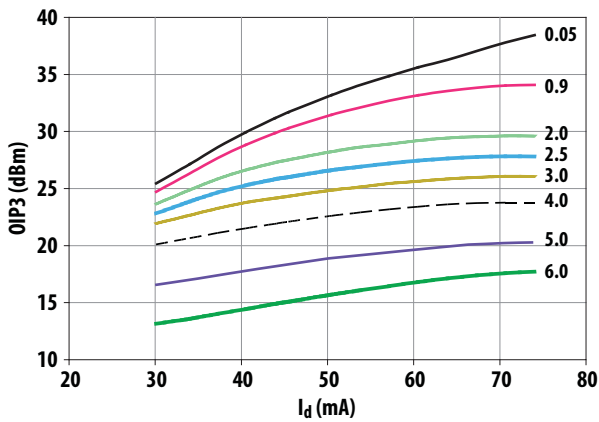

Figure 20. OIP3 vs I_d and Frequency (GHz)

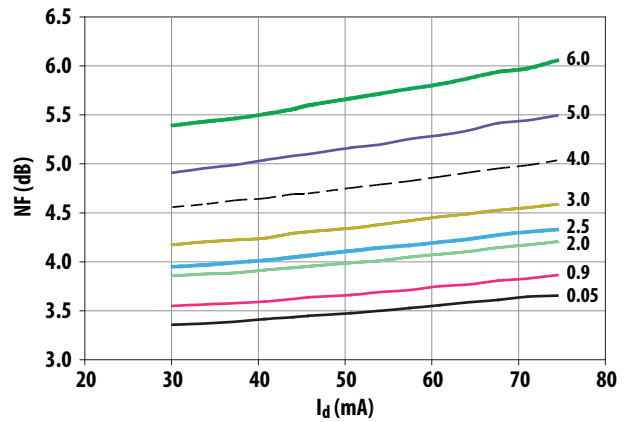

Figure 21. NF vs I_d and Frequency (GHz)

AVT-52663 Typical Performance Curves

$T_A = 25^\circ\text{C}$, $Z_o = 50\ \Omega$, $P_{in} = -15\ \text{dBm}$ (unless specified otherwise), continued

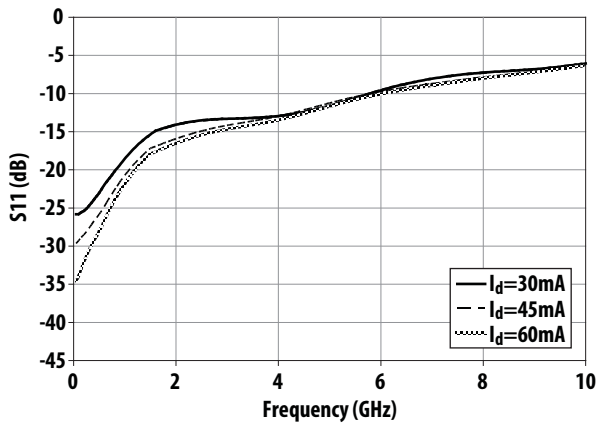

Figure 22. S_{11} vs Frequency and I_d

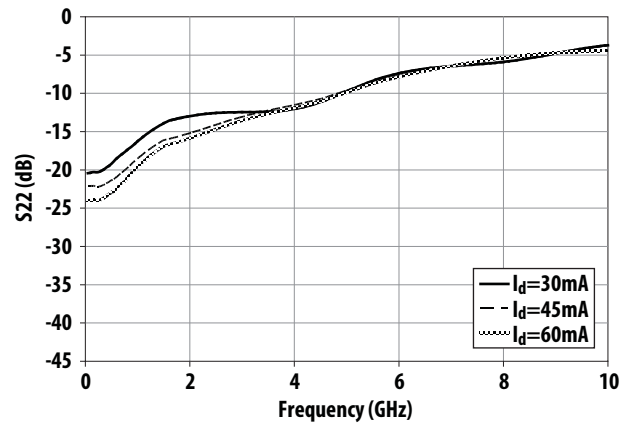

Figure 23. S_{22} vs I_d and Frequency

AVT-52663 Typical Scattering Parameters $T_A = 25\text{ }^\circ\text{C}$, $Z_o = 50\ \Omega$, $I_d = 30\text{ mA}$, (unless specified otherwise)

Id=30mA	S11		S21		S12		S22		K	
	mag	angle	dB	mag	angle	mag	angle	mag		angle
0.05	0.06	1.08	15.78	6.15	178.08	0.11	-1.03	0.09	-0.63	1.1
0.10	0.06	4.55	15.78	6.15	176.13	0.11	-1.84	0.09	-1.01	1.1
0.50	0.07	10.45	15.69	6.09	160.79	0.11	-8.84	0.11	-5.81	1.1
0.90	0.11	1.94	15.56	6.00	145.66	0.11	-15.73	0.14	-16.53	1.1
1.50	0.17	-17.19	15.29	5.81	123.38	0.11	-25.87	0.20	-37.00	1.1
2.00	0.19	-29.76	15.06	5.66	105.08	0.10	-34.18	0.22	-54.04	1.1
2.50	0.21	-43.17	14.81	5.50	87.04	0.10	-42.26	0.24	-70.56	1.1
3.00	0.22	-57.31	14.54	5.33	69.15	0.09	-50.13	0.24	-86.65	1.2
3.50	0.22	-72.83	14.28	5.17	51.22	0.09	-57.78	0.25	-103.25	1.3
4.00	0.23	-90.82	13.99	5.00	33.02	0.08	-65.03	0.26	-121.67	1.4
4.50	0.24	-111.31	13.61	4.79	14.45	0.07	-71.55	0.27	-142.00	1.5
5.00	0.26	-135.34	13.08	4.51	-4.32	0.06	-76.32	0.31	-161.58	1.7
5.50	0.29	-160.04	12.42	4.18	-22.91	0.05	-77.59	0.37	-179.31	2.0
6.00	0.32	178.20	11.66	3.83	-41.00	0.05	-73.98	0.41	163.39	2.2
6.50	0.36	158.29	10.79	3.46	-58.41	0.04	-66.50	0.45	146.59	2.4
7.00	0.40	140.62	9.86	3.11	-75.07	0.05	-58.97	0.48	130.10	2.3
7.50	0.42	124.58	8.89	2.78	-91.04	0.05	-55.04	0.51	114.09	2.0
8.00	0.44	108.83	7.90	2.48	-106.57	0.06	-55.56	0.54	98.76	1.8
8.50	0.45	92.07	6.87	2.21	-121.85	0.07	-59.63	0.56	84.19	1.6
9.00	0.46	74.00	5.75	1.94	-136.92	0.08	-66.07	0.58	70.24	1.5
9.50	0.48	56.10	4.50	1.68	-151.40	0.09	-73.70	0.60	56.89	1.5
10.00	0.51	40.64	3.16	1.44	-164.84	0.09	-81.54	0.61	44.11	1.6
10.50	0.55	28.90	1.76	1.22	-177.02	0.09	-89.03	0.63	31.81	1.6
11.00	0.58	20.51	0.38	1.04	-171.90	0.10	-96.05	0.65	19.93	1.7
11.50	0.60	13.72	-0.96	0.90	161.51	0.10	-102.90	0.66	8.59	1.7
12.00	0.61	6.50	-2.23	0.77	151.40	0.10	-109.98	0.68	-1.98	1.8
12.50	0.61	-2.54	-3.44	0.67	141.26	0.10	-117.52	0.70	-11.70	2.0
13.00	0.61	-13.69	-4.60	0.59	130.99	0.11	-125.56	0.71	-20.65	2.2
13.50	0.62	-26.23	-5.75	0.52	120.60	0.11	-134.06	0.72	-29.26	2.4
14.00	0.63	-38.99	-6.91	0.45	110.15	0.11	-142.94	0.73	-38.13	2.6
14.50	0.65	-51.05	-8.10	0.39	99.74	0.11	-152.04	0.73	-47.66	2.8
15.00	0.67	-61.71	-9.37	0.34	89.75	0.11	-161.02	0.73	-57.72	3.2
16.00	0.70	-76.98	-12.11	0.25	73.22	0.10	-176.26	0.75	-75.90	4.0
17.00	0.72	-84.83	-14.75	0.18	63.44	0.10	-173.72	0.79	-86.50	4.7
18.00	0.72	-90.95	-16.75	0.15	56.48	0.10	164.64	0.80	-93.82	5.5
19.00	0.71	-104.77	-18.47	0.12	46.31	0.11	151.38	0.79	-104.73	7.2
20.00	0.72	-125.76	-20.67	0.09	32.84	0.10	133.46	0.77	-122.61	9.9

Notes:

1. S-parameters are measured on a CPWG line fabricated on 0.025 inch thick Rogers® RO4350 material. The input reference plane is at the end of the input lead. The output reference plane is at the end of the output lead.

AVT-52663 Typical Scattering Parameters $T_A = 25^\circ\text{C}$, $Z_0 = 50 \Omega$, $I_d = 45 \text{ mA}$, (unless specified otherwise)

Id=45mA	S11		S21		S12		S22		K	
	mag	angle	dB	mag	angle	mag	angle	mag		angle
0.05	0.03	1.701	16.3	6.52	178.1	0.11	-0.49	0.08	0.02	1.1
0.10	0.03	7.36	16.3	6.51	176.2	0.11	-1.47	0.08	-0.24	1.1
0.50	0.05	19.21	16.2	6.45	161.2	0.11	-8.12	0.09	-3.15	1.1
0.90	0.08	9.95	16.1	6.37	146.4	0.11	-14.6	0.11	-14.2	1.1
1.50	0.14	-10.3	15.8	6.19	124.4	0.11	-24.2	0.16	-36.8	1.1
2.00	0.16	-21.9	15.6	6.04	106.3	0.1	-32.2	0.17	-55.4	1.1
2.50	0.18	-36.2	15.3	5.85	88.35	0.1	-40	0.2	-73.1	1.1
3.00	0.2	-52.6	15.0	5.65	70.57	0.09	-47.5	0.22	-89.6	1.2
3.50	0.21	-70.6	14.7	5.44	52.89	0.09	-54.8	0.24	-106	1.2
4.00	0.22	-90	14.3	5.22	35.19	0.08	-61.5	0.27	-123	1.3
4.50	0.25	-110	13.9	4.96	17.36	0.07	-67.1	0.29	-141	1.5
5.00	0.27	-130	13.4	4.66	-0.48	0.06	-71	0.33	-160	1.6
5.50	0.3	-151	12.7	4.33	-18.1	0.05	-71.9	0.37	-177	1.8
6.00	0.33	-170	12.0	4	-35.3	0.05	-69	0.41	165.4	2.0
6.50	0.35	172	11.2	3.65	-52.3	0.05	-63.5	0.45	148.1	2.1
7.00	0.37	153.6	10.4	3.3	-68.8	0.05	-57.9	0.48	131.3	2.1
7.50	0.39	135.7	9.4	2.96	-84.7	0.05	-54.9	0.51	115.6	1.9
8.00	0.41	118.4	8.4	2.63	-99.9	0.06	-55.2	0.54	101.3	1.7
8.50	0.42	101.5	7.4	2.34	-115	0.07	-58.2	0.56	88.19	1.6
9.00	0.44	84.93	6.3	2.07	-129	0.08	-63.3	0.58	75.75	1.5
9.50	0.46	69.25	5.2	1.82	-142	0.09	-69.7	0.59	63.26	1.5
10.00	0.49	55.36	4.1	1.6	-155	0.09	-76.8	0.6	50.32	1.5
10.50	0.51	43.36	2.9	1.4	-168	0.1	-84.3	0.61	37	1.5
11.00	0.53	32.49	1.7	1.21	-180	0.1	-92.1	0.63	23.77	1.6
11.50	0.54	21.98	0.4	1.04	168.7	0.1	-99.8	0.65	11.35	1.6
12.00	0.56	11.64	-1.0	0.9	157.8	0.11	-107	0.68	0.336	1.7
12.50	0.57	1.468	-2.3	0.77	147.6	0.11	-115	0.7	-9.14	1.8
13.00	0.59	-8.86	-3.5	0.67	137.8	0.11	-122	0.71	-17.5	2.0
13.50	0.6	-19.7	-4.6	0.59	128.1	0.11	-130	0.72	-25.5	2.1
14.00	0.62	-30.7	-5.8	0.52	118.2	0.11	-138	0.72	-34	2.3
14.50	0.64	-41.3	-6.9	0.45	108.2	0.11	-147	0.72	-43.6	2.6
15.00	0.66	-50.9	-8.0	0.4	98.49	0.11	-155	0.71	-54.1	2.8
16.00	0.69	-66.2	-10.5	0.3	81.12	0.11	-171	0.74	-73	3.3
17.00	0.7	-78.9	-13.0	0.22	68.45	0.1	177.3	0.78	-84.2	3.9
18.00	0.71	-90.9	-15.2	0.17	58.94	0.1	166.9	0.8	-90.9	4.7
19.00	0.73	-102	-17.3	0.14	49.24	0.1	155.3	0.78	-101	6.1
20.00	0.76	-115	-19.6	0.11	37.47	0.1	140.5	0.77	-119	8.0

Notes:

1. S-parameters are measured on a CPWG line fabricated on 0.025 inch thick Rogers® RO4350 material. The input reference plane is at the end of the input lead. The output reference plane is at the end of the output lead.

AVT-52663 Typical Scattering Parameters $T_A = 25^\circ\text{C}$, $Z_0 = 50 \Omega$, $I_d = 60 \text{ mA}$, (unless specified otherwise)

Id=60mA	S11		S21		S12		S22		K	
	mag	angle	dB	mag	angle	mag	angle	mag		angle
0.05	0.019	7.6	16.5	6.656	178.2	0.109	-0.1	0.063	0.4	1.1
0.10	0.020	15.8	16.5	6.646	176.3	0.109	-1.4	0.063	0.8	1.1
0.50	0.039	31.0	16.4	6.588	161.3	0.108	-8.0	0.071	0.6	1.1
0.90	0.072	18.3	16.3	6.498	146.6	0.107	-14.4	0.096	-10.4	1.1
1.50	0.127	-6.1	16.0	6.322	124.7	0.104	-23.9	0.143	-34.1	1.1
2.00	0.149	-17.8	15.8	6.160	106.7	0.101	-31.7	0.161	-52.8	1.1
2.50	0.169	-32.3	15.5	5.972	88.9	0.097	-39.5	0.184	-70.7	1.1
3.00	0.184	-48.8	15.2	5.768	71.2	0.092	-47.0	0.210	-87.3	1.2
3.50	0.197	-66.9	14.9	5.554	53.7	0.086	-54.3	0.233	-103.3	1.2
4.00	0.212	-86.4	14.5	5.330	36.2	0.079	-61.0	0.254	-120.3	1.2
4.50	0.234	-106.4	14.1	5.082	18.6	0.071	-66.8	0.280	-139.0	1.3
5.00	0.260	-127.4	13.6	4.789	0.8	0.063	-71.0	0.320	-157.5	1.5
5.50	0.287	-148.2	13.0	4.468	-16.7	0.055	-72.3	0.366	-175.0	1.6
6.00	0.314	-166.9	12.3	4.137	-33.9	0.048	-69.7	0.404	167.3	2.0
6.50	0.336	174.5	11.6	3.792	-50.9	0.046	-64.1	0.442	149.8	2.1
7.00	0.357	155.9	10.7	3.440	-67.5	0.047	-58.1	0.477	132.9	2.1
7.50	0.378	137.6	9.8	3.092	-83.5	0.052	-54.6	0.510	117.0	1.9
8.00	0.398	120.1	8.8	2.761	-98.8	0.060	-54.5	0.539	102.4	1.7
8.50	0.416	103.0	7.8	2.455	-113.6	0.068	-57.4	0.563	89.1	1.5
9.00	0.436	86.2	6.7	2.175	-127.8	0.077	-62.4	0.580	76.5	1.4
9.50	0.458	70.3	5.7	1.918	-141.6	0.085	-68.9	0.593	63.9	1.4
10.00	0.483	56.2	4.5	1.684	-154.9	0.092	-76.1	0.603	50.8	1.4
10.50	0.505	44.1	3.3	1.469	-167.6	0.098	-83.7	0.615	37.3	1.4
11.00	0.524	33.1	2.1	1.274	-179.7	0.102	-91.6	0.632	24.0	1.5
11.50	0.539	22.4	0.8	1.098	168.7	0.104	-99.4	0.654	11.5	1.5
12.00	0.554	12.0	-0.5	0.943	157.8	0.106	-107.1	0.678	0.4	1.6
12.50	0.570	1.8	-1.8	0.812	147.5	0.107	-114.5	0.700	-9.2	1.7
13.00	0.585	-8.6	-3.0	0.704	137.5	0.108	-122.0	0.716	-17.6	1.8
13.50	0.601	-19.5	-4.2	0.616	127.7	0.109	-129.8	0.722	-25.6	2.0
14.00	0.620	-30.6	-5.3	0.542	117.7	0.110	-138.0	0.721	-34.2	2.2
14.50	0.642	-41.2	-6.4	0.477	107.7	0.111	-146.5	0.716	-43.8	2.4
15.00	0.664	-50.8	-7.6	0.417	97.8	0.111	-155.1	0.715	-54.2	2.7
16.00	0.692	-66.2	-10.0	0.315	80.2	0.108	-170.5	0.740	-73.2	3.1
17.00	0.698	-78.8	-12.5	0.236	67.3	0.105	177.4	0.780	-84.4	3.7
18.00	0.708	-90.9	-14.8	0.183	57.5	0.103	166.9	0.796	-91.0	4.5
19.00	0.731	-102.3	-16.8	0.144	47.5	0.101	155.3	0.783	-101.5	5.8
20.00	0.761	-115.2	-19.2	0.110	35.3	0.096	140.5	0.770	-119.4	7.7

Notes:

1. S-parameters are measured on a CPWG line fabricated on 0.025 inch thick Rogers® RO4350 material. The input reference plane is at the end of the input lead. The output reference plane is at the end of the output lead.

Part Number Ordering Information

Part Number	No. of Devices	Container
AVT-52663-TR1G	3000	7" Reel
AVT-52663-BLKG	100	Antistatic Bag

Package Dimensions

Outline 63 (SOT-363/SC-70)

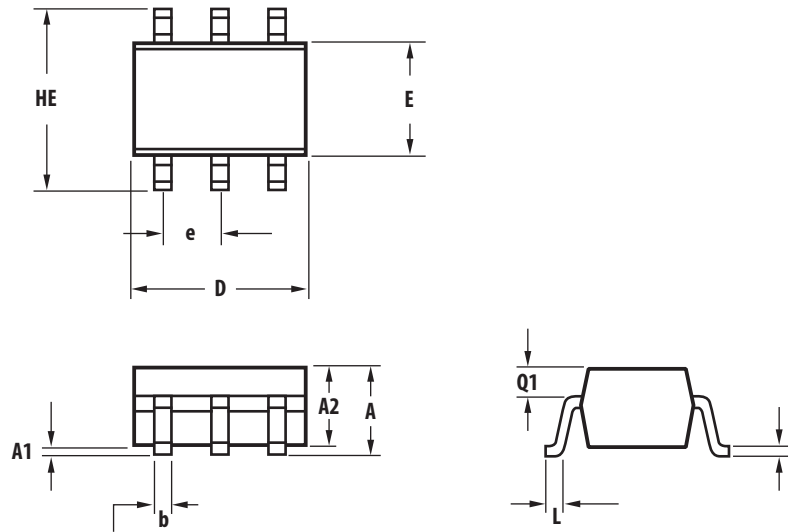

SYMBOL	DIMENSIONS (mm)	
	MIN.	MAX.
E	1.15	1.35
D	1.80	2.25
HE	1.80	2.40
A	0.80	1.10
A2	0.80	1.00
A1	0.00	0.10
Q1	0.10	0.40
e	0.65	
b	0.15	0.30
c	0.08	0.25
L	0.10	0.46

Notes:

1. All dimensions are in mm.
2. Dimensions are inclusive of plating.
3. Dimensions are exclusive of mold flash & metal burr.
4. All specifications comply to EIAJSC70.
5. Die is facing up for mold and facing down for trim/form, ie: reverse trim/form.
6. Package surface to be mirror finish. 0.650BCS.

Recommended PCB Pad Layout for Avago's SC70 6L/SOT-363 Products

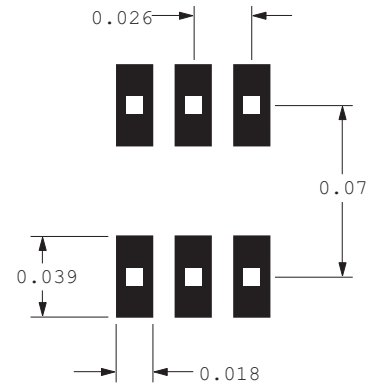

Dimensions in inch

Device Orientation

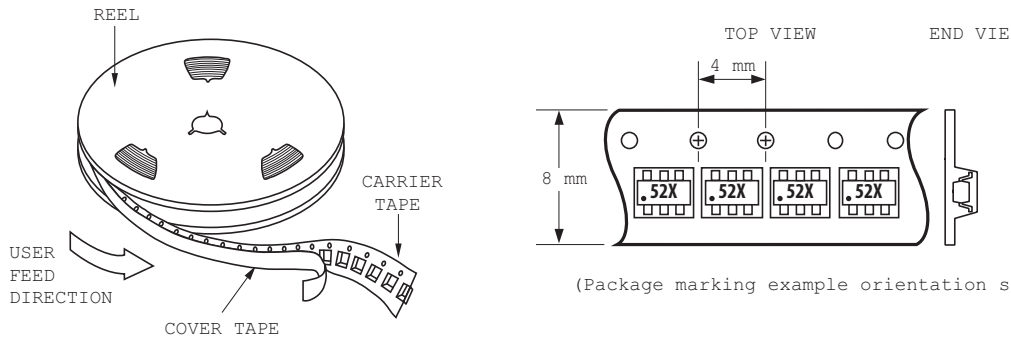

Tape Dimensions and Product Orientation for Outline 63

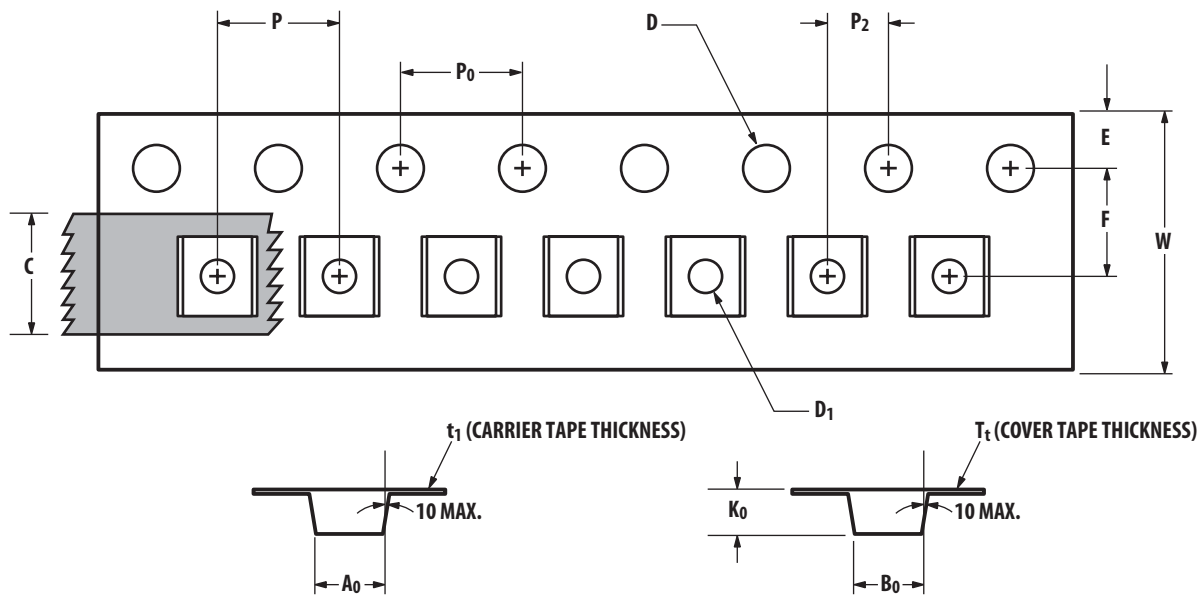

DESCRIPTION		SYMBOL	SIZE (mm)	SIZE (INCHES)
CAVITY	LENGTH	A ₀	2.40 0.10	0.094 0.004
	WIDTH	B ₀	2.40 0.10	0.094 0.004
	DEPTH	K ₀	1.20 0.10	0.047 0.004
	PITCH	P	4.00 0.10	0.157 0.004
	BOTTOM HOLE DIAMETER	D ₁	1.00 ± 0.25	0.039 ± 0.010
PERFORATION	DIAMETER	D	1.50 0.10	0.061 ± 0.002
	PITCH	P ₀	4.00 0.10	0.157 0.004
	POSITION	E	1.75 0.10	0.069 0.004
CARRIER TAPE	WIDTH	W	8.00 ± 0.30 - 0.10	0.315 ± 0.012
	THICKNESS	t ₁	0.254 0.02	0.0100 0.0008
COVER TAPE	WIDTH	C	5.40 0.10	0.205 ± 0.004
	TAPE THICKNESS	T _t	0.062 0.001	0.0025 0.0004
DISTANCE	CAVITY TO PERFORATION (WIDTH DIRECTION)	F	3.50 0.05	0.138 0.002
	CAVITY TO PERFORATION (LENGTH DIRECTION)	P ₂	2.00 0.05	0.079 0.002

Reel Dimensions - 7 inch

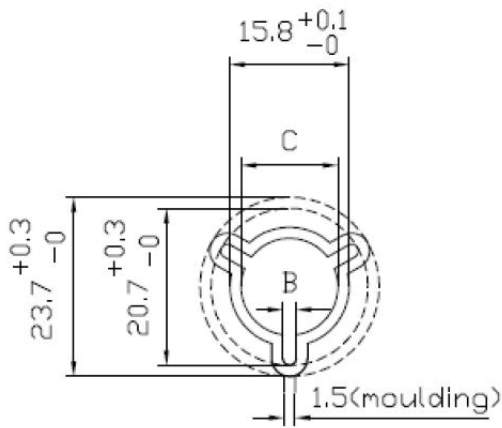
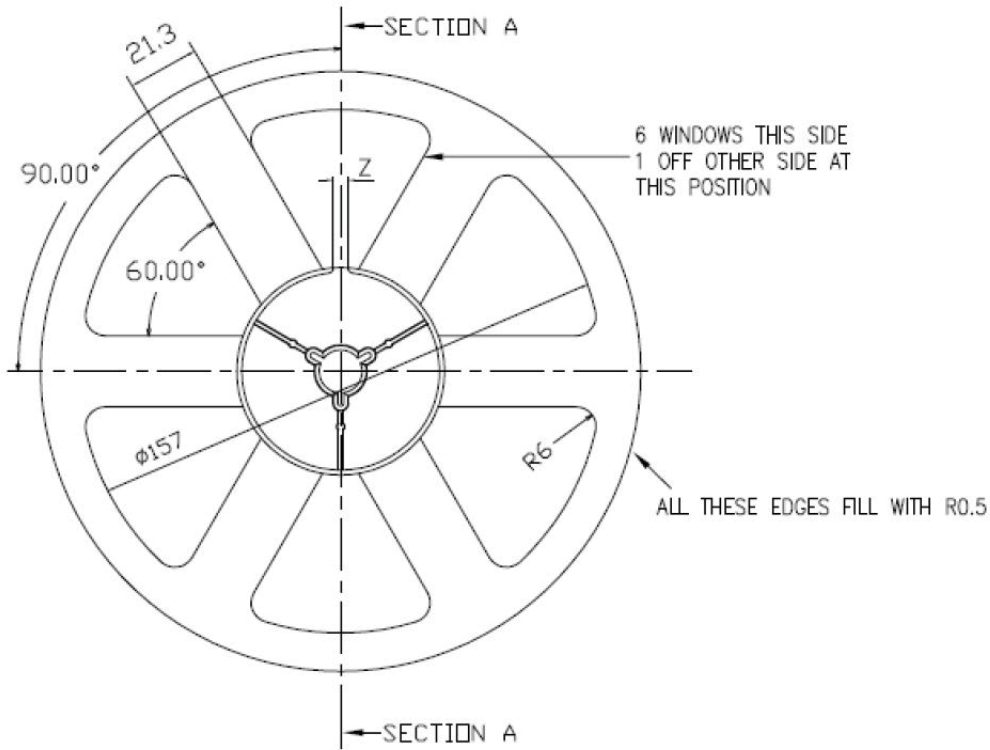

HUB DETAIL

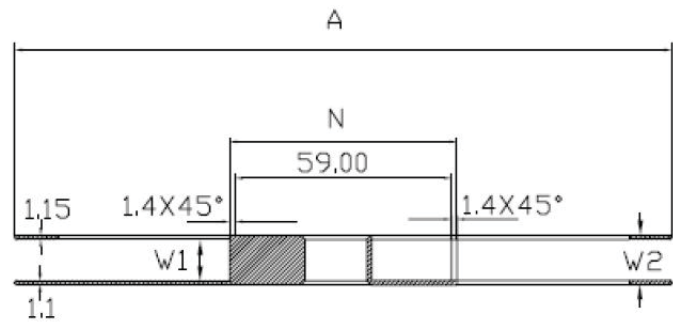

SECTION A

For product information and a complete list of distributors, please go to our web site: www.avagotech.com

Avago, Avago Technologies, and the A logo are trademarks of Avago Technologies in the United States and other countries. Data subject to change. Copyright © 2005-2010 Avago Technologies. All rights reserved. AV02-2245EN - April 29, 2010

