



Chipsmall Limited consists of a professional team with an average of over 10 year of expertise in the distribution of electronic components. Based in Hongkong, we have already established firm and mutual-benefit business relationships with customers from,Europe,America and south Asia,supplying obsolete and hard-to-find components to meet their specific needs.

With the principle of “Quality Parts,Customers Priority,Honest Operation,and Considerate Service”,our business mainly focus on the distribution of electronic components. Line cards we deal with include Microchip,ALPS,ROHM,Xilinx,Pulse,ON,Everlight and Freescale. Main products comprise IC,Modules,Potentiometer,IC Socket,Relay,Connector.Our parts cover such applications as commercial,industrial, and automotives areas.

We are looking forward to setting up business relationship with you and hope to provide you with the best service and solution. Let us make a better world for our industry!



Contact us

Tel: +86-755-8981 8866 Fax: +86-755-8427 6832

Email & Skype: info@chipsmall.com Web: www.chipsmall.com

Address: A1208, Overseas Decoration Building, #122 Zhenhua RD., Futian, Shenzhen, China



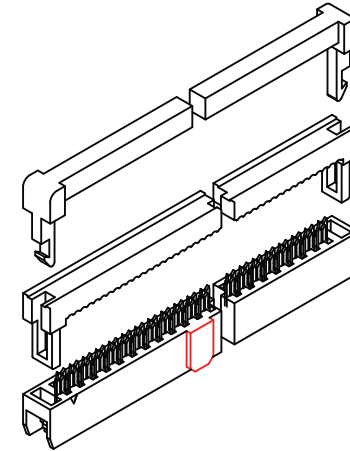
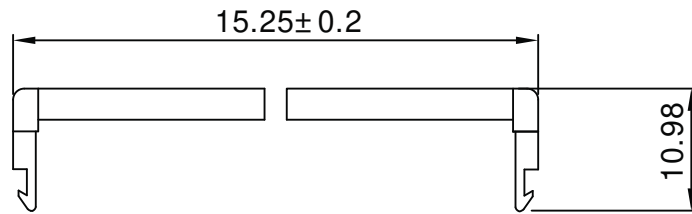
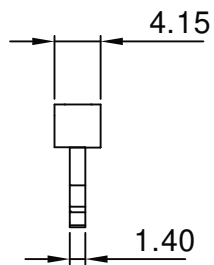

I.D.C. SOCKET DUAL-ROW

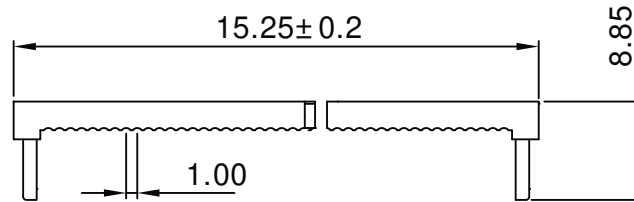
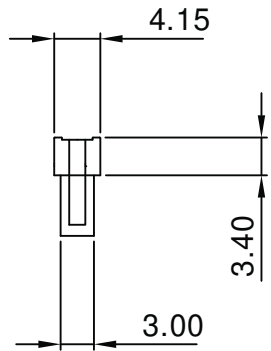

Material:

- Insulator: P.B.T. 30% Glass Fiber, UL 94V-0
- Contact Material: Phosphor Bronze, Gold flash over Nickel

Electrical:

- Current Rating: 1Amp DC
- Insulation Resistance: 1,000MΩ Min.
- Dielectric Withstanding: 500V AC
- Operating Temperature: -55°C ~ +105°C

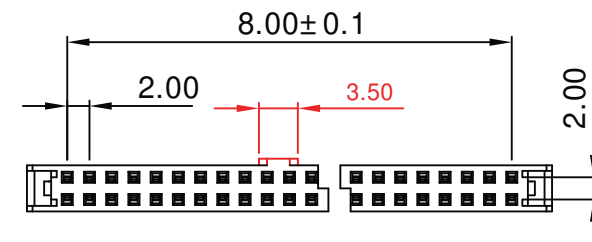
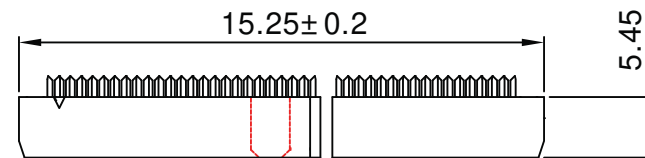
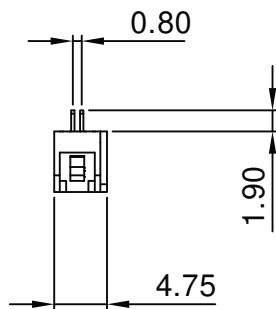

Scale	1:1					Date	Name	Title IDC Socket - 10 contact Gold flash, 2.00mm pitch, w/central polarisation, w/strain relief	
TOLERANCE						Drawn	19.10.11	Chappell	
X.X	±0.40					Approved			ASSMANN WSW-No.
X.XX	±0.25								AWP2-10-7241
X.XXX	±0.15								Drawing-No.
DIM	TOL								rev00
X.°	±3°								
X.X°	±X°	①	Updated part number	09.08.13	Wilson				Sheet
Angle	TOL	Id.	Modification	Date	Name	<small>1840 W. Drake Drive, Suite 101 • Tempe, AZ 85283 Toll Free: 1-877-277-6266 • Email: info@assmann.us</small>			1/1

Unit: mm



1

2

3

4

5

6

7