



Chipsmall Limited consists of a professional team with an average of over 10 year of expertise in the distribution of electronic components. Based in Hongkong, we have already established firm and mutual-benefit business relationships with customers from,Europe,America and south Asia,supplying obsolete and hard-to-find components to meet their specific needs.

With the principle of “Quality Parts,Customers Priority,Honest Operation,and Considerate Service”,our business mainly focus on the distribution of electronic components. Line cards we deal with include Microchip,ALPS,ROHM,Xilinx,Pulse,ON,Everlight and Freescale. Main products comprise IC,Modules,Potentiometer,IC Socket,Relay,Connector.Our parts cover such applications as commercial,industrial, and automotives areas.

We are looking forward to setting up business relationship with you and hope to provide you with the best service and solution. Let us make a better world for our industry!



Contact us

Tel: +86-755-8981 8866 Fax: +86-755-8427 6832

Email & Skype: info@chipsmall.com Web: www.chipsmall.com

Address: A1208, Overseas Decoration Building, #122 Zhenhua RD., Futian, Shenzhen, China



1 channel-Bi-direction/2-channel-Uni-direction

Active Optical Connector

V Series

New

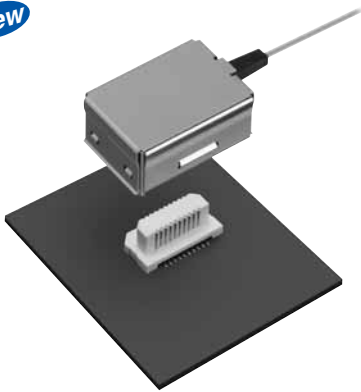

Mated height: 6.5mm

RoHS compliant

FEATURES

1. Plug is equipped with electrical/optical conversion function.
2. Noise reduction of high speed signal and electrical isolation easily achieved.
3. High speed and wide data rate transmission possible
4. Lineup includes 1 channel-Bi-direction and 2-channel-Uni-direction
 - 1 channel-Bi-direction: 20 Mbps to Max. 6 Gbps
 - 2 channel-Uni-direction: 20 Mbps to Max. 16 Gbps (20 Mbps to 8 Gbps/ch)

APPLICATIONS

- Measuring equipment
 - Image processing instrument
 - Printer
 - Medical equipment
 - Industrial robots, etc.
- And other high speed transmission, noise reduction and electrical isolation applications

DETAILED FEATURES

1. Plug is equipped with electrical/optical conversion function.

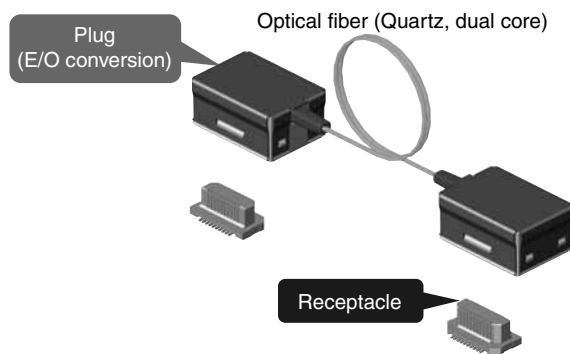

1 channel-Bi-direction: Max. 6 Gbps transmission

Being able to reverse the dual core optical fiber transfer direction makes it ideal for such applications as mutual high speed transfer between connected PC boards.

2 channel-Uni-direction: Max. 16 Gbps transmission (8 Gbps/ch)

Being able to use the dual core optical fiber unidirectionally makes it ideal for high capacity (max. 16 Gbps) transfer applications.

2. The differential input signal is converted to an optical signal by the Laser Diode Driver (LDD) and Laser Diode (LD) in the plug.

The optical signal is transmitted through the optical fiber and reproduced as differential output signal by the Photo Diode (PD) and Trans Impedance Amplifier (TIA).

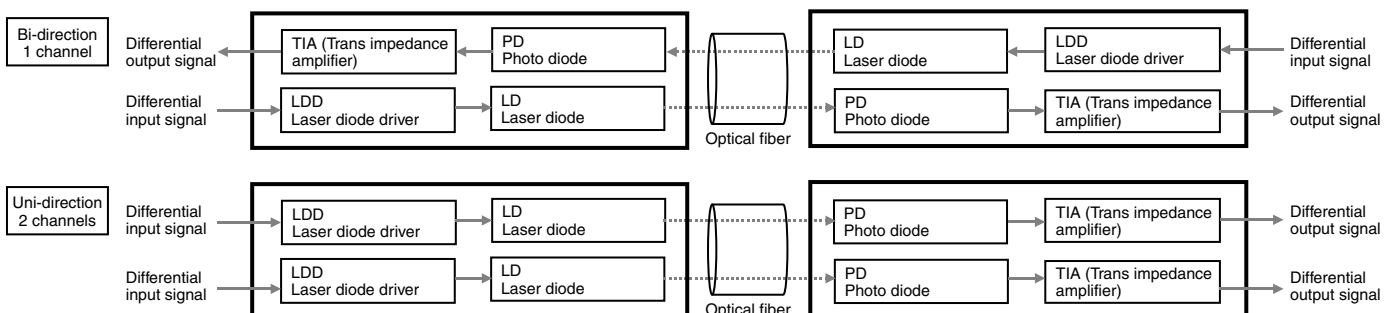

PRODUCT TYPES 1 channel-Bi-direction

1. Integrated cable and plug

Transmission rate	Transmission specifications	Cable length	Part No.	Packing quantity
20 Mbps to 6 Gbps/ch	1 channel-Bi-direction	50 mm	AYG4V10565M1	10 pieces
		500 mm	AYG4V15065M1	
		1000 mm	AYG4V1A065M1	
		50 mm	AYG4V10565M3	100 pieces
		500 mm	AYG4V15065M3	
		1000 mm	AYG4V1A065M3	

2. Receptacle (both 1 channel-Bi-direction and 2 channel-Uni-direction)

Receptacle	Part No.	Packing quantity
	AXK6S20447M1	20 pieces
	AXK6S20447M3	200 pieces (reel)

SPECIFICATIONS 1 channel-Bi-direction

1. Rated specifications (per channel)

Item	Min.	Typical	Max.	Unit	Condition
Supply voltage	3.2	3.3	3.4	V	—
Power consumption	—	—	230	mW	Bi-direction 1channel
Transmission rate (per channel)	0.02	—	6	Gbps	8b/10b coding
Input/output characteristic impedance	80	100	125	Ω	—
Differential input voltage	400	—	1600	mVpp	peak-to-peak
Input common mode voltage	150	—	340	mV	Note 1)
Input total jitter	—	—	0.24	UI	Note 2)
Input rise-time	—	—	0.30	UI	Note 2), 3), 20% to 80%
Input fall-time	—	—	0.30	UI	Note 2), 3), 20% to 80%
Differential output voltage	300	440	550	mVpp	Note 2), peak-to-peak
Output common mode voltage	150	250	275	mV	Note 2)
Output rise-time	—	—	0.50	UI	Note 2), 20% to 80%
Output fall-time	—	—	0.50	UI	Note 2), 20% to 80%
Output total jitter	—	—	0.60	UI	Note 2), Dj + Rjpp

Notes: 1. When performing AC coupling, the input common mode voltage is 0 to 1.8 V.

2. Input data pattern is PRBS 2⁷-1.

Rjpp is equivalent to BER 10⁻¹².

3. When the transmission rate is under 1.5 Gbps, the time is up to 200 ps.

2. Use conditions

Item	Performance	Remarks
Operating ambient temperature	0°C to +70°C	No icing or condensation.
Storage temperature	-20°C to +50°C (Packaged form) -20°C to +85°C (Product only)	No icing or condensation.
Relative humidity	20% to 80%RH	No condensation.
Electrical static discharge	2kV	Applied 3 times on the external shell C = 100pF, R = 1.5k Ω C = 150pF, R = 330 Ω
Immunity	Conformed to IEC61000-6-2 standard	—
Electromagnetic interference	Conformed to VCCI class B standard	—
Composite insertion force	Max. 15.7N (Initial stage)	—
Composite removal force	Min. 1.17N	—
Insertion and removal life	50 times Composite removal force: Min. 1.17N Contact resistance: Max. 60 m Ω	Repeated insertion and removal cycles of Max. 200 times/hour

3. Materials specifications

Component name	Materials	Specifications and Remarks
Shell	Copper alloy	Nickel plating
Bushing	Elastomer	Black
Optical fiber	Silica, UV-cured resin	Cross section: 0.4 × 0.6 mm, 2 cores
Connector	LCP resin, copper alloy	Terminal (Au-plating on Ni-base)
Photoelectric conversion PC board	Glass-fibered epoxy, epoxy resin, etc.	—
IC	CMOS	—
Laser Diode	GaAs	—
Photo diode	GaAs	—

TERMINAL LAYOUT 1 channel-Bi-direction

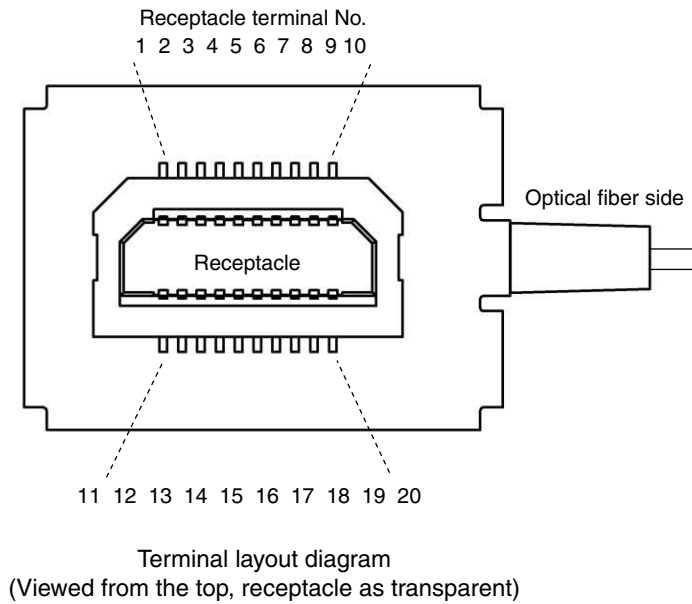

No.	Name
1	Monitor
2	GND
3	Differential output -
4	Differential output +
5	GND
6	Open
7	Open
8	Power Supply
9	Power Supply
10	GND
11	Open
12	GND
13	Differential input -
14	Differential input +
15	GND
16	GND
17	Power Supply
18	Power Supply
19	Power Supply
20	GND

PRODUCT TYPES 2 channel-Uni-direction**1. Integrated cable and plug**

Transmission rate	Transmission specifications	Cable length	Part No.	Packing quantity
20 Mbps to 8 Gbps/ch	2 channel-Uni-direction	50 mm	AYG5V10585M1	10 pieces
		500 mm	AYG5V15085M1	
		1000 mm	AYG5V1A085M1	
		50 mm	AYG5V10585M3	100 pieces
		500 mm	AYG5V15085M3	
		1000 mm	AYG5V1A085M3	

2. Receptacle (both 1 channel-Bi-direction and 2 channel-Uni-direction)

Receptacle	Part No.	Packing quantity
	AXK6S20447M1	20 pieces
	AXK6S20447M3	200 pieces (reel)

SPECIFICATIONS 2 channel-Uni-direction**1. Rated specifications (per channel)**

Item	Min.	Typical	Max.	Unit	Condition
Supply voltage	3.2	3.3	3.4	V	—
Power consumption	—	—	230	mW	Uni-direction, 2 channels
Transmission rate (per channel)	0.02	—	8	Gbps	8b/10b coding
Input/output characteristic impedance	80	100	125	Ω	—
Differential input voltage	400	—	1600	mVpp	peak-to-peak
Input common mode voltage	150	—	340	mV	Note 1)
Input total jitter	—	—	0.24	UI	Note 2)
Input rise-time	—	—	0.30	UI	Note 2), 3), 20% to 80%
Input fall-time	—	—	0.30	UI	Note 2), 3), 20% to 80%
Differential output voltage	300	440	550	mVpp	Note 2), peak-to-peak
Output common mode voltage	150	250	275	mV	Note 2)
Output rise-time	—	—	0.50	UI	Note 2), 20% to 80%
Output fall-time	—	—	0.50	UI	Note 2), 20% to 80%
Output total jitter	—	—	0.60	UI	Note 2), Dj + Rjpp

Notes: 1. When performing AC coupling, the input common mode voltage is 0 to 1.8 V.

2. Input data pattern is PRBS 2⁷-1.

Rjpp is equivalent to BER 10⁻¹².

3. When the transmission rate is under 1.5 Gbps, the time is up to 200 ps.

2. Use conditions

Item	Performance	Remarks
Operating ambient temperature	0°C to +70°C	No icing or condensation.
Storage temperature	-20°C to +50°C (Packaged form) -20°C to +85°C (Product only)	No icing or condensation.
Relative humidity	20% to 80%RH	No condensation.
Electrical static discharge	2kV	Applied 3 times on the external shell C = 100pF, R = 1.5k Ω C = 150pF, R = 330 Ω
Immunity	Conformed to IEC61000-6-2 standard	—
Electromagnetic interference	Conformed to VCCI class B standard	—
Composite insertion force	Max. 15.7N (Initial stage)	—
Composite removal force	Min. 1.17N	—
Insertion and removal life	50 times Composite removal force: Min. 1.17N Contact resistance: Max. 60 m Ω	Repeated insertion and removal cycles of Max. 200 times/hour

3. Materials specifications

Component name	Materials	Specifications and Remarks
Shell	Copper alloy	Nickel plating
Bushing	Elastomer	Black
Optical fiber	Silica, UV-cured resin	Cross section: 0.4 × 0.6 mm, 2 cores
Connector	LCP resin, copper alloy	Terminal (Au-plating on Ni-base)
Photoelectric conversion PC board	Glass-fibered epoxy, epoxy resin, etc.	—
IC	CMOS	—
Laser Diode	GaAs	—
Photo diode	GaAs	—

TERMINAL LAYOUT 2 channel-Uni-direction

<Transmitter side>

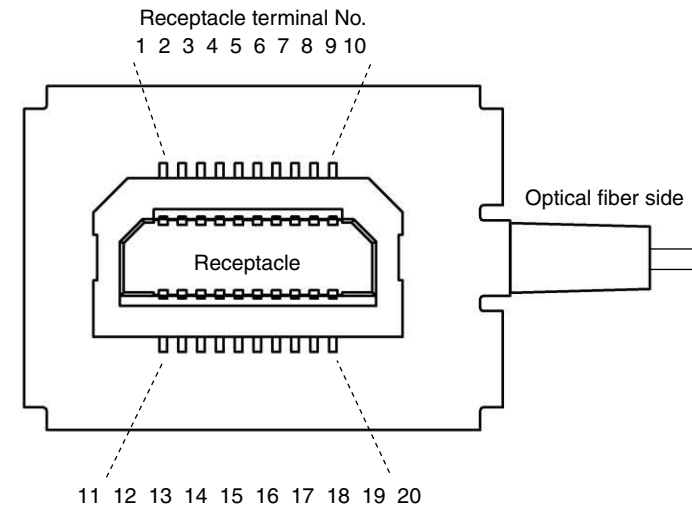

Terminal layout diagram
(Viewed from the top, receptacle as transparent)

No.	Name
1	Open
2	GND
3	ch1 Differential input +
4	ch1 Differential input -
5	GND
6	Open
7	Power Supply
8	Power Supply
9	Open
10	GND
11	Open
12	GND
13	ch2 Differential input -
14	ch2 Differential input +
15	GND
16	Open
17	Power Supply
18	Power Supply
19	Open
20	GND

<Receiver side>

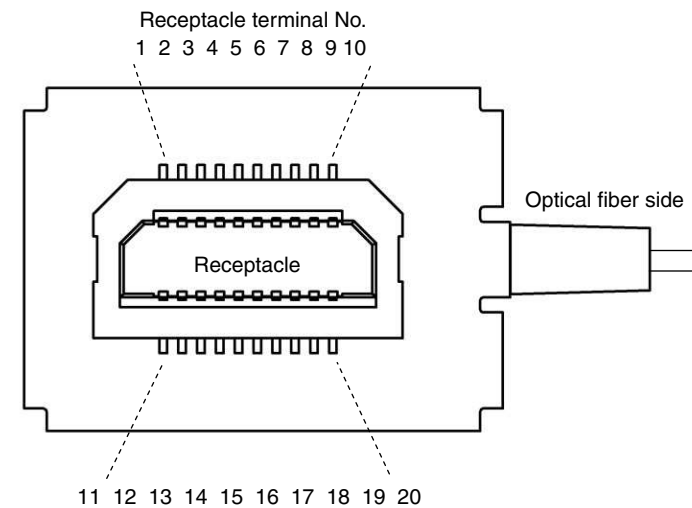

Terminal layout diagram
(Viewed from the top, receptacle as transparent)

No.	Name
1	Open
2	GND
3	ch2 Differential output -
4	ch2 Differential output +
5	GND
6	Monitor (ch2)
7	Open
8	Open
9	Power Supply
10	GND
11	Open
12	GND
13	ch1 Differential output +
14	ch1 Differential output -
15	GND
16	Monitor (ch1)
17	Open
18	Open
19	Power Supply
20	GND

Active Optical Connector V Series

DIMENSIONS both 1 channel-Bi-direction and 2 channel-Uni-direction (Unit: mm)

1. Integrated cable and plug

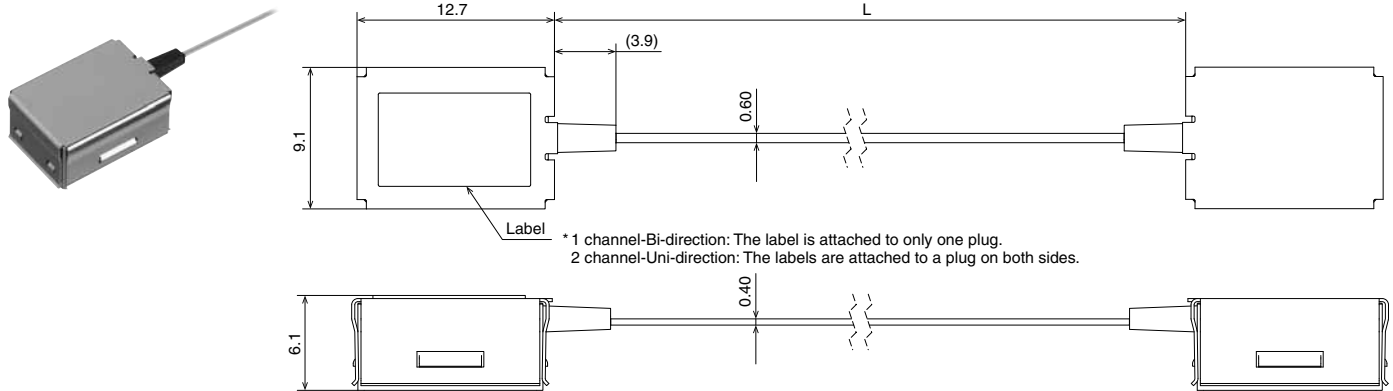

General tolerance: ± 0.3

1 channel-Bi-direction

L: Cable length (mm)	Tolerance (mm)	Part No.
50	+10 -0	AYG4V10565
500	+50 -0	AYG4V15065
1000	+100 -0	AYG4V1A065

2 channel-Uni-direction

L: Cable length (mm)	Tolerance (mm)	Part No.
50	+10 -0	AYG5V10585
500	+50 -0	AYG5V15085
1000	+100 -0	AYG5V1A085

2. Receptacle

External dimensions

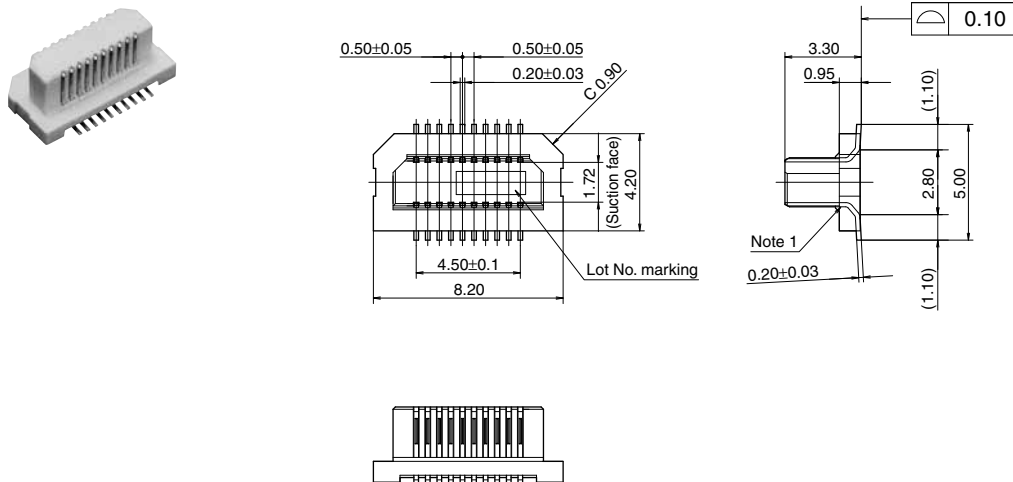

General tolerance: ± 0.2

Note 1: The terminal close to the portion to be soldered have nickel barriers (except nickel portions).

3. Plug and receptacle are mated

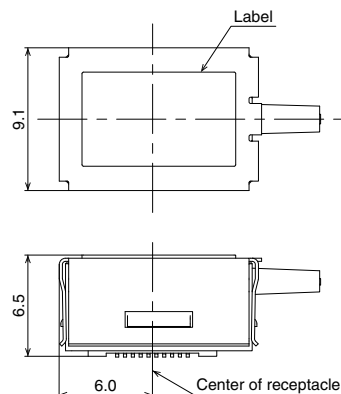

EMBOSSED TAPE DIMENSIONS (Unit: mm)

Receptacle: Embossed tape packaging

• Specifications for taping (In accordance with JIS C 0806:1990. However, not applied to the mounting-hole pitch of some connectors.)

• Specifications for the plastic reel (In accordance with EIAJ ET-7200B.)

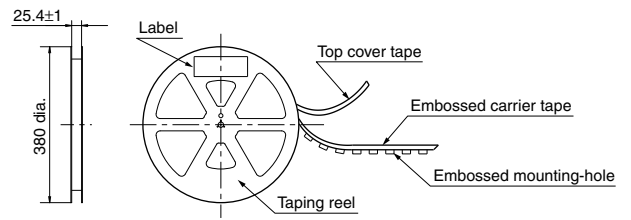
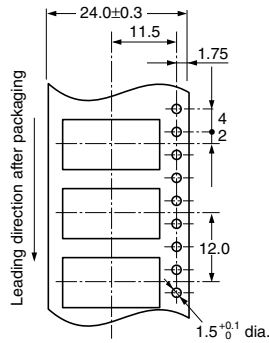

Receptacle orientation with respect to embossed tape feeding direction

Direction of tape progress	Type	Receptacle

Please refer to the latest product specifications when designing your product.

Notes on Using Active Optical Connector V Series

■ About safety Remarks

- 1) Do not use these connectors beyond the specification sheets. The usage outside of specified rated current, dielectric strength, and environmental conditions and so on may cause circuitry damage via abnormal heating, smoke, and fire.
- 2) In order to avoid accidents, your thorough specification review is appreciated. Please contact us if your usage is out of the specifications. Otherwise, Panasonic Corporation cannot guarantee the quality and reliability.
- 3) Panasonic Corporation is consistently striving to improve quality and reliability. However, the fact remains that electrical components and devices generally cause failures at a given statistical probability. Furthermore, their durability varies with use environments or use conditions. In this respect, please check for actual electrical components and devices under actual conditions before use. Continued usage in a state of degraded condition may cause the deteriorated insulation, thus result in abnormal heat, smoke or firing. Please carry out safety design and periodic maintenance including redundancy design, design for fire spread prevention, and design for malfunction prevention so that no accidents resulting in injury or death, fire accidents, or social damage will be caused as a result of failure of the products or ending life of the products.
- 4) When the optical fiber breaks, immediately shut off the power. This product uses a laser diode (class 1M) of non-visible light with oscillation wavelength 850 nm. The laser beam does not irradiate outside in normal operation, but a breakage of the optical fiber may cause irradiation outside. Do not look into the optical fiber by using optical equipment. Laser beam may cause danger to human eyes.

■ Cautions when using the product

- Please use the product in accordance with the conditions described in these specifications.
- The product quality cannot be warranted if the product fails because it is used outside the conditions in these specifications.
- 1) Cautions about the operating and storage environments
 - Product failure due to condensation cannot be warranted.
 - Use caution for avoiding dust.
 - The following environment may deteriorate the product's appearance and affect the product characteristics, and should thus be avoided.
 - An environment in which the possible adherence of chemicals such as acid and alkali exists.
 - In a gaseous atmosphere of salt, sulfide, etc.
 - 2) This product has a structure requiring an insertion force for mating, but the mating may come off when an external force is applied to the plug, impact is applied by dropping, or vibration is applied in equipment. Sufficient caution should be used with the equipment to avoid such incidents.
 - 3) The product cannot be used in a movable parts while the optical fiber is bent. Such use may cause deformation of the receptacle or breakage of the optical fiber.
 - 4) In order to avoid a load on the plug and receptacle applied by the tensile force of the optical fiber, a redundant design is required with respect to the optical fiber length.

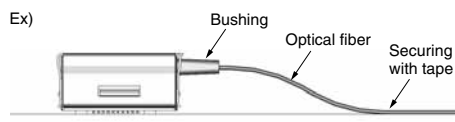

- 5) Use caution for wiring the optical fiber to avoid getting entangled or twisting. Also, use adhesive tape for securing the optical fiber for preventing excessive stress caused by vibration and impact.
- 6) Insertion and removal operations must be performed while the power is off. Insertion or removal operations in a live condition (with current and voltage) may lead to a breakage.
- 7) Use caution with regard to the generation and handling of static electricity in the operating environment to protect the plug.
- 8) Secure sufficient insulation distance between the external metal enclosure of the plug and the peripheral components. The plug enclosure, which is connected to the ground, may give rise to danger from a short-circuit.
- 9) Mating of plug
 - Mating direction
Mating of the plug and receptacle requires orientation. Align the receptacle shape in the direction of the optical fiber of plug.
 - Mated condition
Make sure the plug is securely inserted into the receptacle. After mating, a gap remains between the PC board and plug. Avoid applying excessive pressure.

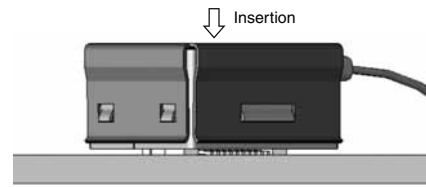

- 10) Plug removal
For the removal operation, hold both sides of the metal enclosure and lift the plug upward.
* Do not pull the optical fiber and bushing.

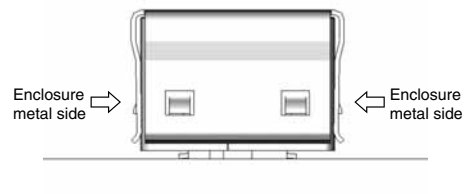

- 11) Plug insertion
Because this product has been designed with a thin mating structure between the plug and receptacle for compact-sizing purposes, excessive tilting during insertion or removal leads to product fracture and separation of the solder section of terminals.
For avoiding breakage of the mating parts, confirm the alignment before mating.

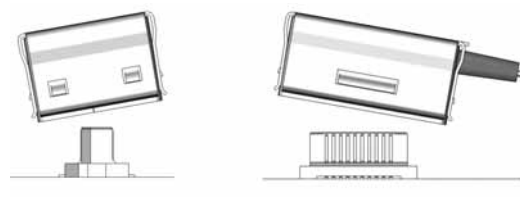

12) Component prohibited area

The shaded area cannot be used for the placement of other components since it is used by the active optical connector. The PC board in the shaded area should be covered with solder resist except for the receptacle's mounting pad.

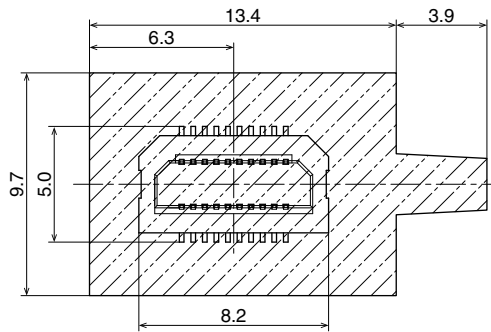

13) When the product is used in a different environment and in accordance with a method other than described in this document, please consult us.

■ Receptacle

Recommended PC board pattern (TOP VIEW)

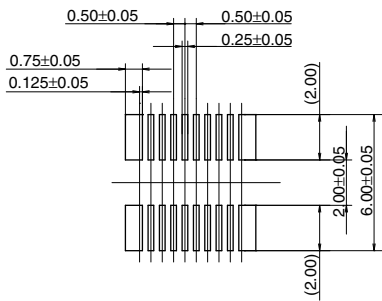

Recommended metal mask pattern
Metal mask thickness: When 150 μ m
(Opening ratio: 69%)

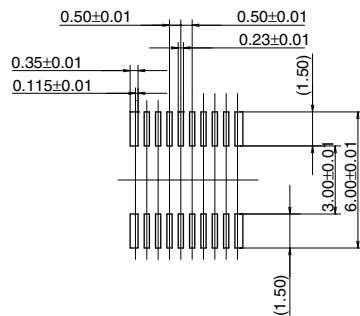

Recommended metal mask pattern
Metal mask thickness: When 120 μ m
(Opening ratio: 87%)

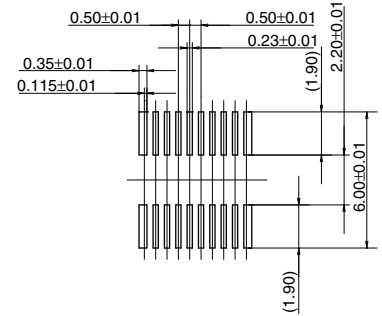

Regarding soldering (for Receptacle)

■ Reflow soldering

- 1) Measure the recommended profile temperature for reflow soldering by placing a sensor on the PC board near the connector surface or terminals. (Please refer to the specification for detail because the temperature setting differs by products.)
- 2) As for cream solder printing, screen printing is recommended.
- 3) When setting the screen opening area and PC board foot pattern area, refer the recommended PC board pattern and window size of metal mask on the specification sheet, and make sure that the size of board pattern and metal mask at the base of the terminals are not increased.
- 4) Please pay attentions not to provide too much solder. It makes miss mating because of interference at soldering portion when mating.

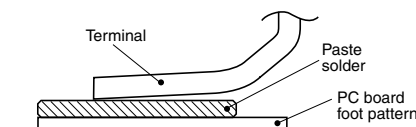

- 5) When mounting on both sides of the PC board and the connector is mounting on the underside, use adhesives or other means to ensure the connector is properly fixed to the PC board. (Double reflow soldering on the same side is possible.)
- 6) The condition of solder or flux rise and wettability varies depending on the type of solder and flux. Solder and flux characteristics should be taken into consideration and also set the reflow temperature and oxygen level.
- 7) Do not use resin-containing solder. Otherwise, the contacts might be firmly fixed.
- 8) Soldering conditions
Please use the reflow temperature profile conditions recommended below for reflow soldering. Please contact us before using a temperature profile other than that described below (e.g. lead-free solder).

• Narrow pitch connectors

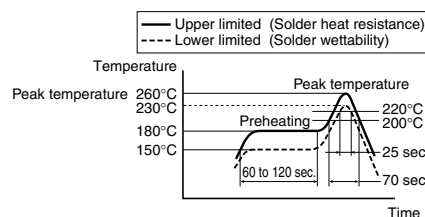

- 9) The temperature profiles given in this catalog are values measured when using the connector on a resin-based PC board. When performed reflow soldering on a metal board (iron, aluminum, etc.) or a metal table to mount on a FPC, make sure there is no deformation or discoloration of the connector before mounting.
- 10) Consult us when using a screen-printing thickness other than that recommended.

Manual soldering

1) Set the soldering iron so that the tip temperature is less than that given in the table below.

Table A

Product name	Soldering iron temperature
SMD type connectors	300°C within 5 sec. 350°C within 3 sec.

2) Do not allow flux to spread onto the connector leads or PC board. This may lead to flux rising up to the connector inside.

3) Touch the soldering iron to the foot pattern. After the foot pattern and connector terminal are heated, apply the solder wire so it melts at the end of the connector terminals.

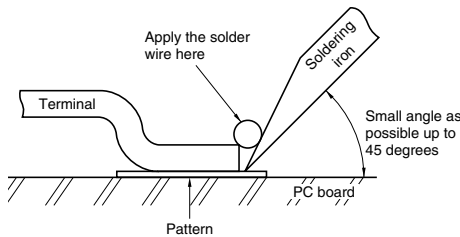

4) Be aware that soldering while applying a load on the connector terminals may cause improper operation of the connector.

5) Thoroughly clean the soldering iron.

6) Flux from the solder wire may get on the contact surfaces during soldering operations. After soldering, carefully check the contact surfaces and clean off any solder before use.

7) These connector is low profile type. If too much solder is supplied for hand soldering, It makes miss mating because of interference at soldering portion. Please pay attentions.

Solder reworking

1) Finish reworking in one operation.

2) In case of soldering rework of bridges. Don't use supplementary solder flux. Doing so may cause contact problems by flux.

3) Keep the soldering iron tip temperature below the temperature given in Table A.

Handling Single Components (for Receptacle)

1) Make sure not to drop or allow parts to fall from work bench.

2) Excessive force applied to the terminals could cause warping, come out, or weaken the adhesive strength of the solder. Handle with care.

3) Do not insert or remove the connector when it is not soldered. Forcibly applied external pressure on the terminals can weaken the adherence of the terminals to the molded part or cause the terminals to lose their evenness.

Cleaning flux from PC board (for Receptacle)

There is no need to clean this product. If cleaning it, pay attention to the following points to prevent the negative effect to the product.

1) Keep the cleaning solvent clean and prevent the connector contacts from contamination.

2) Some cleaning solvents are strong and they may dissolve the molded part and characters, so pure water passed liquid solvent is recommended.

Handling the PC board after mounting the connector (for Receptacle)

When cutting or bending the PC board after mounting the connector, be careful that the soldered sections are subjected to excessive force.

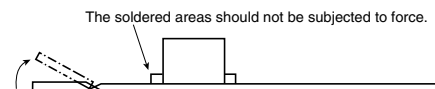

Storage of connectors (for Receptacle)

- 1) To prevent problems from voids or air pockets due to heat of reflow soldering, avoid storing the connectors in areas of high humidity.
- 2) Depending on the connector type, the color of the connector may vary from connector to connector depending on when it is produced.

- Some connectors may change color slightly if subjected to ultraviolet rays during storage. This is normal and will not affect the operation of the connector.
- 3) When storing the connectors with the PC boards assembled and components already set, be careful not to stack them up so the connectors are subjected to

- excessive forces.
- 4) Avoid storing the connectors in locations with excessive dust. The dust may accumulate and cause improper connections at the contact surfaces.

Other Notes (for Receptacle)

- 1) Do not remove or insert the electrified connector (in the state of carrying current or applying voltage).
- 2) Dropping of the products or rough mishandling may bend or damage the terminals and possibly hinder proper reflow soldering.
- 3) Before soldering, try not to insert or remove the connector more than absolutely necessary.

- 4) When coating the PC board after soldering the connector to prevent the deterioration of insulation, perform the coating in such a way so that the coating does not get on the connector.
- 5) There may be variations in the colors of products from different production lots. This is normal.
- 6) The connectors are not meant to be used for switching.

- 7) Product failures due to condensation are not covered by warranty.

Installation direction (for Plug)

The plugs on each end of the optical fiber cable of 2 channel-Uni-direction active optical connectors are different (transmission side and receiving side). The cable will not work if inserted incorrectly; therefore, please verify the ends prior to installation. The receiving end plug has an arrow printed on it for the purpose of verification.

Please implement a measure to avoid incorrect insertion such as by printing a similar mark on the PC board.

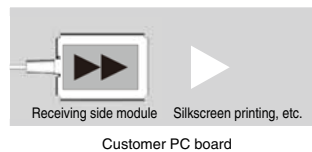

Please contact

Panasonic Corporation

Electromechanical Control Business Division

■ 1006, Oaza Kadoma, Kadoma-shi, Osaka 571-8506, Japan
industrial.panasonic.com/ac/e/

Panasonic[®]

©Panasonic Corporation 2016