



Chipsmall Limited consists of a professional team with an average of over 10 year of expertise in the distribution of electronic components. Based in Hongkong, we have already established firm and mutual-benefit business relationships with customers from,Europe,America and south Asia,supplying obsolete and hard-to-find components to meet their specific needs.

With the principle of “Quality Parts,Customers Priority,Honest Operation,and Considerate Service”,our business mainly focus on the distribution of electronic components. Line cards we deal with include Microchip,ALPS,ROHM,Xilinx,Pulse,ON,Everlight and Freescale. Main products comprise IC,Modules,Potentiometer,IC Socket,Relay,Connector.Our parts cover such applications as commercial,industrial, and automotives areas.

We are looking forward to setting up business relationship with you and hope to provide you with the best service and solution. Let us make a better world for our industry!



## Contact us

Tel: +86-755-8981 8866 Fax: +86-755-8427 6832

Email & Skype: info@chipsmall.com Web: www.chipsmall.com

Address: A1208, Overseas Decoration Building, #122 Zhenhua RD., Futian, Shenzhen, China



# AYZ Series Miniature Slide Switches



## Features/Benefits

- Low profile
- Single & double pole models
- Double & triple throw models
- RoHS compatible

## Typical Applications

- Computer peripherals & network products
- Telecommunication products
- Test & measurement equipment

## Specifications

MAX. SWITCHING POWER: 1.2 VA  
 MAX. SWITCHING VOLTAGE: 12 VDC  
 MAX. SWITCHING CURRENT: 100 mA  
 MECHANICAL LIFE: 10,000 operations.  
 CONTACT RESISTANCE: <math><80\text{m}\Omega</math>  
 INSULATION RESISTANCE: >10  $\Omega$   
 DIELECTRIC STRENGTH: 0.1 kV at 50 Hz/1 min.  
 OPERATING TEMPERATURE: -10°C to +60°C  
 PACKAGING: Tape & reel, see page I-47.

## Materials

HOUSING: Glass filled nylon 4/6 (UL 94V-0).  
 ACTUATOR: Glass filled nylon 6/6 (UL 94V-0), except options ending in C which are glass filled nylon 4/6 (UL94V-0).  
 COVER: Nickel silver.  
 MOVABLE CONTACT: Copper alloy, silver plated.  
 FIXED CONTACT: Brass, silver plated.  
 CONTACT SPRING: Contact bronze.

**NOTE:** Specifications and materials listed above are for switches with standard options. For information on specific and custom switches, consult Customer Service Center.

## How To Order

Complete part numbers for AYZ Series Miniature Slide Switches are shown on pages I-46 through I-48.

### PC MOUNTING

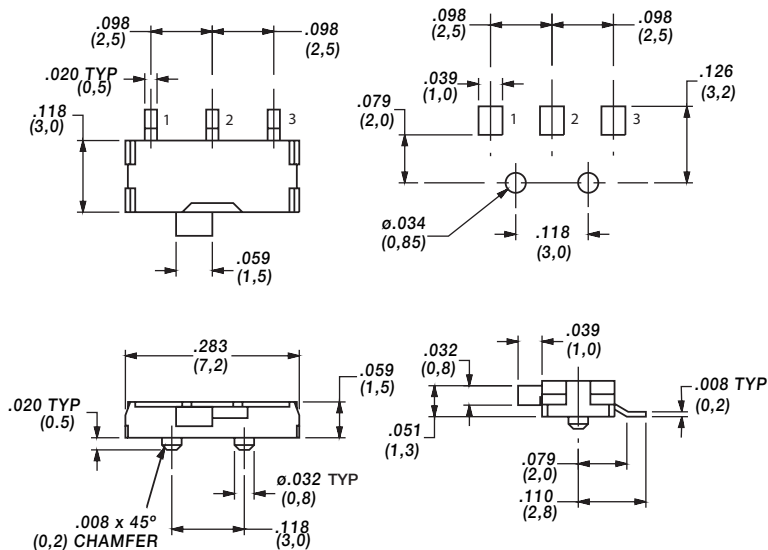

SWITCH SHOWN IN POSITION 1

PART NUMBER	RoHS		SWITCH FUNCTION	
	Compliant	Compatible	POS.1	POS.2
<b>AYZ0102AGRLC</b>	<b>YES</b>	<b>YES</b>		
CONN. TERMINALS			1-2	2-3
SCHEMATIC				
SPDT				



Dimensions are shown: Inch (mm)  
 Specifications and dimensions subject to change



Slide

# AYZ Series Miniature Slide Switches

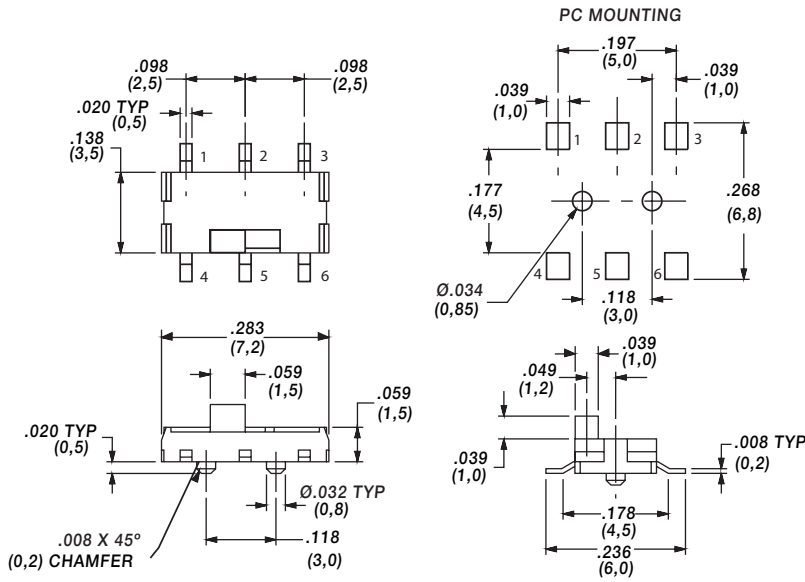

SWITCH SHOWN IN POSITION 1

PART NUMBER	RoHS		SWITCH FUNCTION	
	Compliant	Compatible	POS.1	POS.2
<b>AYZ0202AGRLC</b>	YES	YES		
CONN. TERMINALS			1-2,4-5	2-3,5-6
SCHEMATIC				
DPDT				

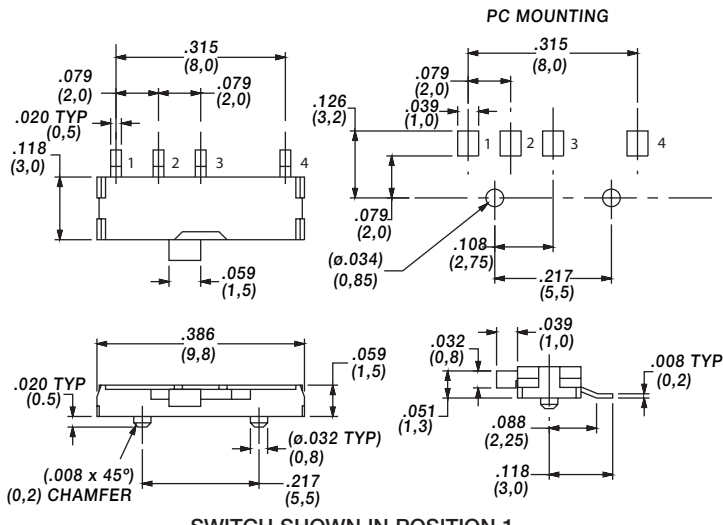
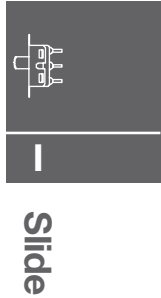

SWITCH SHOWN IN POSITION 1

PART NUMBER	ROHS		SWITCH FUNCTION		
	Compliant	Compatible	POS.1	POS.2	POS.3
<b>AYZ0103AGRLC</b>	YES	YES			
CONN. TERMINALS			1-3	2-C	3-4
SCHEMATIC					
SP3T					

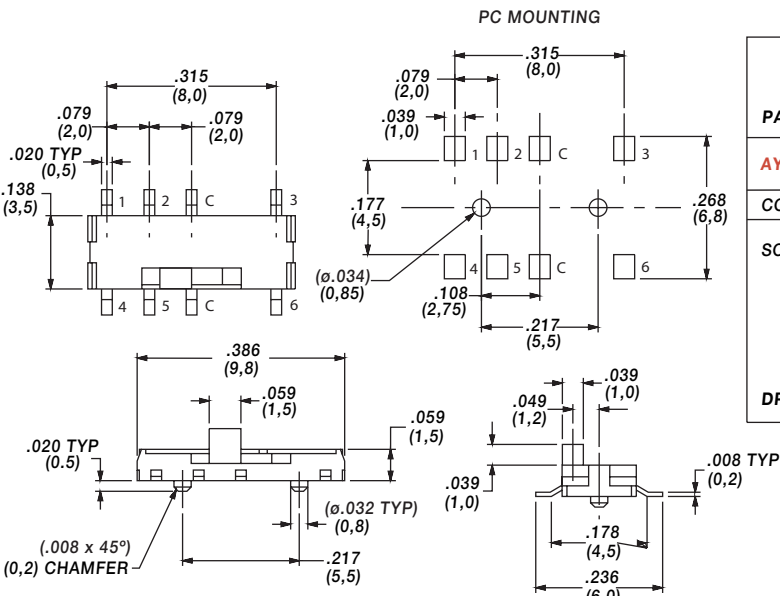

SWITCH SHOWN IN POSITION 1

PART NUMBER	ROHS		SWITCH FUNCTION		
	Compliant	Compatible	POS.1	POS.2	POS.3
<b>AYZ0203AGRLC</b>	YES	YES			
CONN. TERMINALS			1-C,4-C	2-C,5-C	3-C,6-C
SCHEMATIC					
DP3T					



Third Angle Projection

Dimensions are shown: Inches (mm)  
Specifications and dimensions subject to change



# AYZ Series Miniature Slide Switches

## TAPE & REEL

For part number AYZ0102AGRLC

Quantity per reel 4000

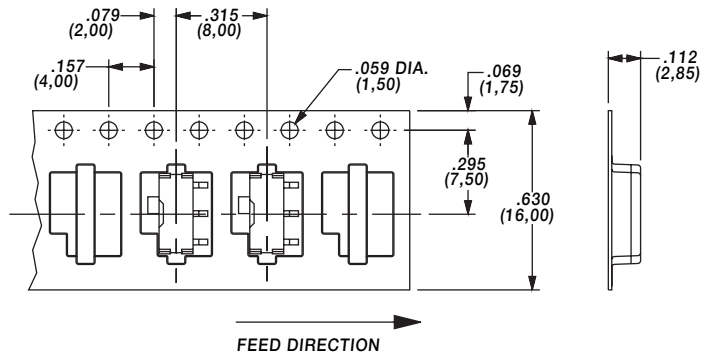

For part number AYZ0103AGRLC

Quantity per reel 4000

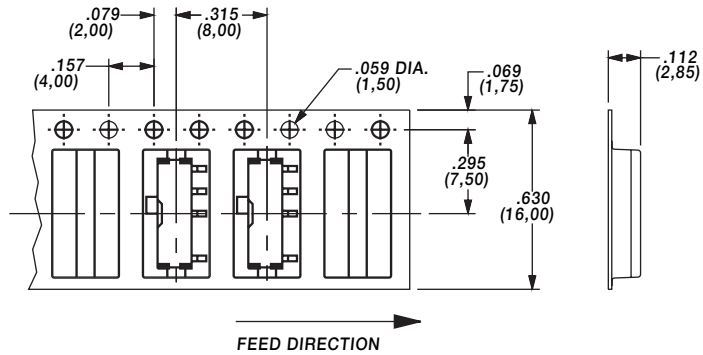

For part number AYZ0202AGRLC

Quantity per reel 3000

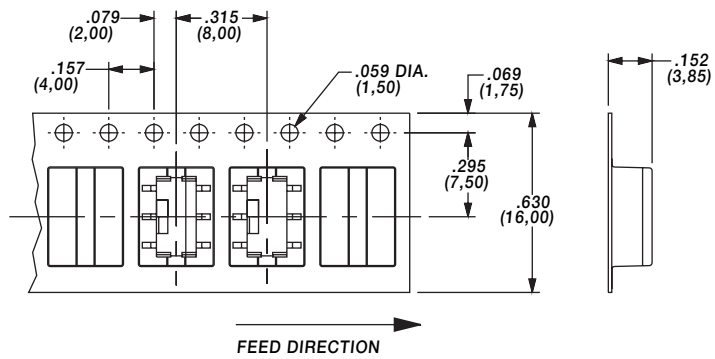

For part number AYZ0203AGRLC

Quantity per reel 3000

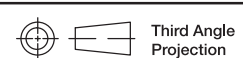
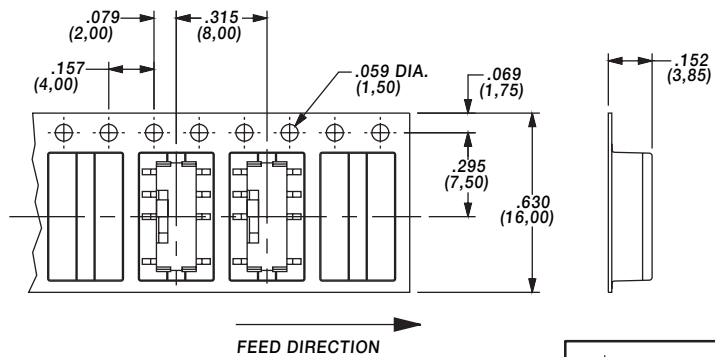

Dimensions are shown: Inch (mm)  
Specifications and dimensions subject to change

