



Chipsmall Limited consists of a professional team with an average of over 10 year of expertise in the distribution of electronic components. Based in Hongkong, we have already established firm and mutual-benefit business relationships with customers from,Europe,America and south Asia,supplying obsolete and hard-to-find components to meet their specific needs.

With the principle of “Quality Parts,Customers Priority,Honest Operation,and Considerate Service”,our business mainly focus on the distribution of electronic components. Line cards we deal with include Microchip,ALPS,ROHM,Xilinx,Pulse,ON,Everlight and Freescale. Main products comprise IC,Modules,Potentiometer,IC Socket,Relay,Connector.Our parts cover such applications as commercial,industrial, and automotives areas.

We are looking forward to setting up business relationship with you and hope to provide you with the best service and solution. Let us make a better world for our industry!



Contact us

Tel: +86-755-8981 8866 Fax: +86-755-8427 6832

Email & Skype: info@chipsmall.com Web: www.chipsmall.com

Address: A1208, Overseas Decoration Building, #122 Zhenhua RD., Futian, Shenzhen, China



1.5A LOW DROPOUT LINEAR REGULATOR

AZ1086

General Description

The AZ1086 is a series of low dropout positive voltage regulators with a maximum dropout of 1.5V at 1.5A of load current.

The series features on-chip thermal shutdown. It also includes a bandgap reference and a current limiting circuit.

The AZ1086 is available in 1.5V, 1.8V, 2.5V, 3.0V, 3.3V, and 5.0V versions. The fixed versions integrate the adjust resistors. It is also available in an adjustable version, which can set the output voltage with only two external resistors.

The AZ1086 series is available in standard packages of TO-263-3, TO-220-3, SOT-223, TO-252-2 (1), TO-252-2 (3) and TO-252-2 (4).

Features

- Low Dropout Voltage: Typical 1.3V at 1.5A
- Current Limiting and Thermal Protection
- Output Current: 1.5A
- Current Limit: 2.3A
- Operating Junction Temperature: 0 to 125°C
- Line Regulation: 0.015% (Typical)
- Load Regulation: 0.1% (Typical)

Applications

- High Efficiency Linear Regulators
- Battery Charger
- Post Regulation for Switching Supply
- Microprocessor Supply
- Motherboard Power Supply
- Cable and ADSL Modem
- DVD-Video Player
- Telecom Equipment
- Set Top Boxes and Web Boxes Modules' Supply

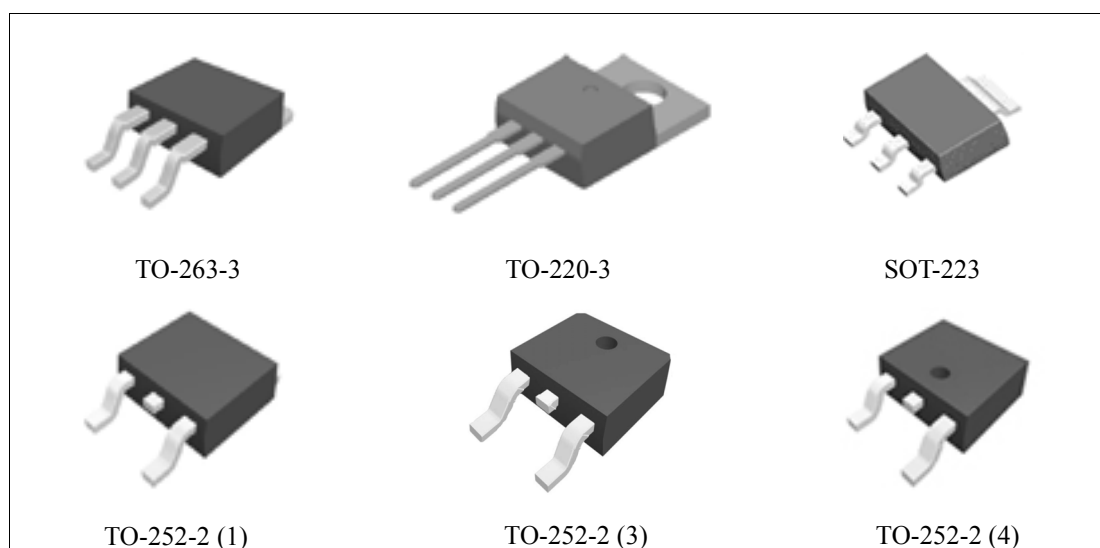

Figure 1. Package Types of AZ1086

1.5A LOW DROPOUT LINEAR REGULATOR

AZ1086

Pin Configuration

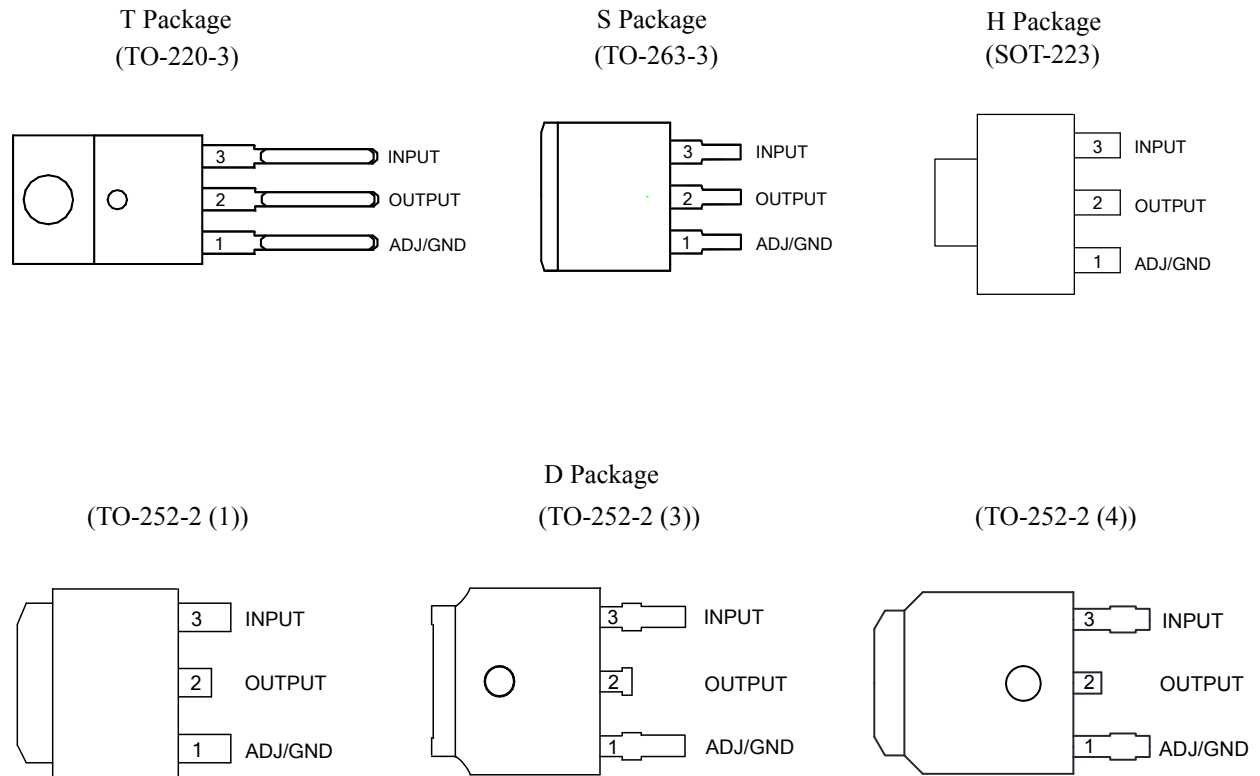

Figure 2. Pin Configuration of AZ1086 (Top View)

1.5A LOW DROPOUT LINEAR REGULATOR

AZ1086

Functional Block Diagram

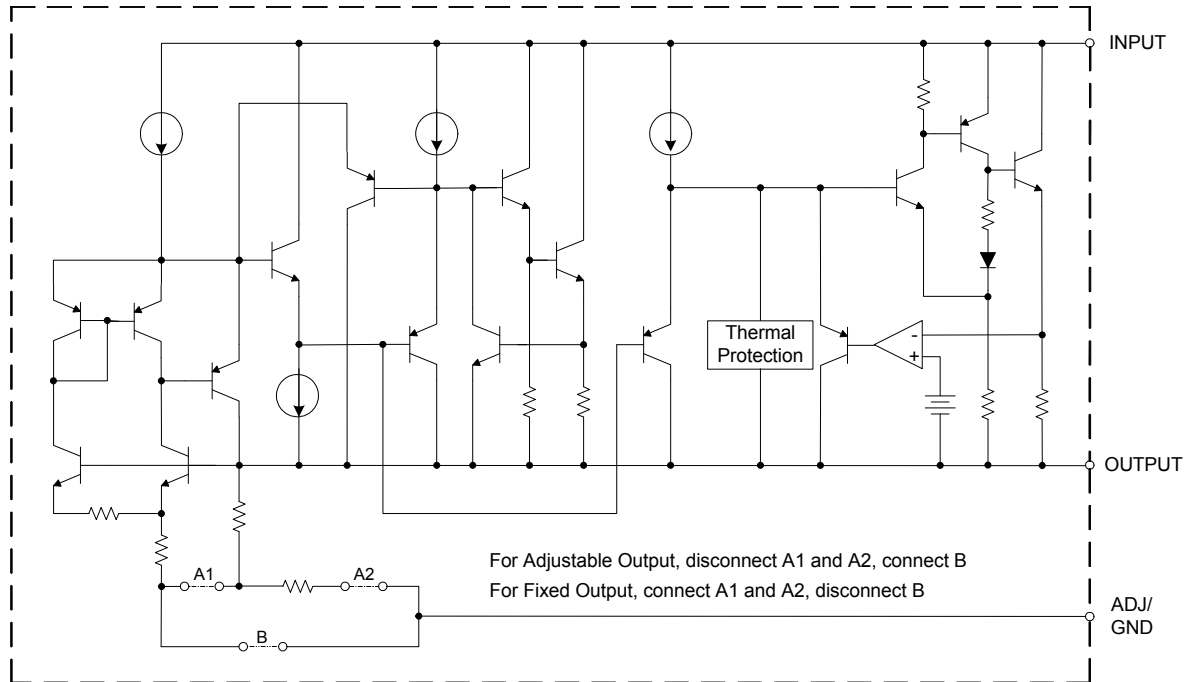

Figure 3. Functional Block Diagram of AZ1086



1.5A LOW DROPOUT LINEAR REGULATOR

AZ1086

Ordering Information

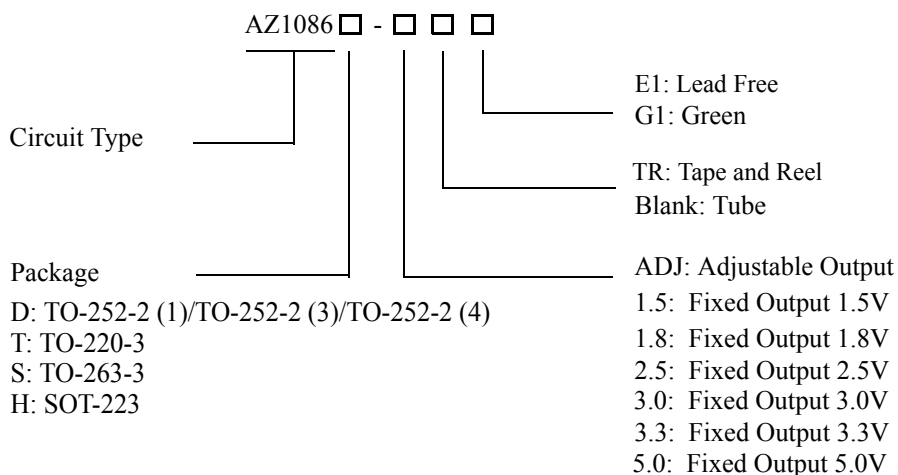

Package	Temperature Range	Part Number		Marking ID		Packing Type
		Lead Free	Green	Lead Free	Green	
TO-252-2 (1)/ TO-252-2 (3)/ TO-252-2 (4)	0 to 125°C	AZ1086D-ADJTRE1	AZ1086D-ADJTRG1	AZ1086D-ADJE1	AZ1086D-ADJG1	Tape & Reel
		AZ1086D-1.5TRE1	AZ1086D-1.5TRG1	AZ1086D-1.5E1	AZ1086D-1.5G1	Tape & Reel
		AZ1086D-1.8TRE1	AZ1086D-1.8TRG1	AZ1086D-1.8E1	AZ1086D-1.8G1	Tape & Reel
		AZ1086D-2.5TRE1	AZ1086D-2.5TRG1	AZ1086D-2.5E1	AZ1086D-2.5G1	Tape & Reel
		AZ1086D-3.0TRE1	AZ1086D-3.0TRG1	AZ1086D-3.0E1	AZ1086D-3.0G1	Tape & Reel
		AZ1086D-3.3TRE1	AZ1086D-3.3TRG1	AZ1086D-3.3E1	AZ1086D-3.3G1	Tape & Reel
		AZ1086D-5.0TRE1	AZ1086D-5.0TRG1	AZ1086D-5.0E1	AZ1086D-5.0G1	Tape & Reel
TO-220-3	0 to 125°C	AZ1086T-ADJE1	AZ1086T-ADJG1	AZ1086T-ADJE1	AZ1086T-ADJG1	Tube
		AZ1086T-1.5E1	AZ1086T-1.5G1	AZ1086T-1.5E1	AZ1086T-1.5G1	Tube
		AZ1086T-1.8E1	AZ1086T-1.8G1	AZ1086T-1.8E1	AZ1086T-1.8G1	Tube
		AZ1086T-2.5E1	AZ1086T-2.5G1	AZ1086T-2.5E1	AZ1086T-2.5G1	Tube
		AZ1086T-3.0E1	AZ1086T-3.0G1	AZ1086T-3.0E1	AZ1086T-3.0G1	Tube
		AZ1086T-3.3E1	AZ1086T-3.3G1	AZ1086T-3.3E1	AZ1086T-3.3G1	Tube
		AZ1086T-5.0E1	AZ1086T-5.0G1	AZ1086T-5.0E1	AZ1086T-5.0G1	Tube

**1.5A LOW DROPOUT LINEAR REGULATOR****AZ1086****Ordering Information (Continued)**

Package	Temperature Range	Part Number		Marking ID		Packing Type
		Lead Free	Green	Lead Free	Green	
TO-263-3	0 to 125°C	AZ1086S-ADJE1	AZ1086S-ADJG1	AZ1086S-ADJE1	AZ1086S-ADJG1	Tube
		AZ1086S-ADJTRE1	AZ1086S-ADJTRG1	AZ1086S-ADJE1	AZ1086S-ADJG1	Tape & Reel
		AZ1086S-1.5E1	AZ1086S-1.5G1	AZ1086S-1.5E1	AZ1086S-1.5G1	Tube
		AZ1086S-1.5TRE1	AZ1086S-1.5TRG1	AZ1086S-1.5E1	AZ1086S-1.5G1	Tape & Reel
		AZ1086S-1.8E1	AZ1086S-1.8G1	AZ1086S-1.8E1	AZ1086S-1.8G1	Tube
		AZ1086S-1.8TRE1	AZ1086S-1.8TRG1	AZ1086S-1.8E1	AZ1086S-1.8G1	Tape & Reel
		AZ1086S-2.5E1	AZ1086S-2.5G1	AZ1086S-2.5E1	AZ1086S-2.5G1	Tube
		AZ1086S-2.5TRE1	AZ1086S-2.5TRG1	AZ1086S-2.5E1	AZ1086S-2.5G1	Tape & Reel
		AZ1086S-3.0E1	AZ1086S-3.0G1	AZ1086S-3.0E1	AZ1086S-3.0G1	Tube
		AZ1086S-3.0TRE1	AZ1086S-3.0TRG1	AZ1086S-3.0E1	AZ1086S-3.0G1	Tape & Reel
		AZ1086S-3.3E1	AZ1086S-3.3G1	AZ1086S-3.3E1	AZ1086S-3.3G1	Tube
		AZ1086S-3.3TRE1	AZ1086S-3.3TRG1	AZ1086S-3.3E1	AZ1086S-3.3G1	Tape & Reel
		AZ1086S-5.0E1	AZ1086S-5.0G1	AZ1086S-5.0E1	AZ1086S-5.0G1	Tube
		AZ1086S-5.0TRE1	AZ1086S-5.0TRG1	AZ1086S-5.0E1	AZ1086S-5.0G1	Tape & Reel
SOT-223	0 to 125°C	AZ1086H-ADJTRE1	AZ1086H-ADJTRG1	EH86A	GH86A	Tape & Reel
		AZ1086H-1.5TRE1	AZ1086H-1.5TRG1	EH86B	GH86B	Tape & Reel
		AZ1086H-1.8TRE1	AZ1086H-1.8TRG1	EH86E	GH86E	Tape & Reel
		AZ1086H-2.5TRE1	AZ1086H-2.5TRG1	EH86C	GH86C	Tape & Reel
		AZ1086H-3.0TRE1	AZ1086H-3.0TRG1	EH86G	GH86G	Tape & Reel
		AZ1086H-3.3TRE1	AZ1086H-3.3TRG1	EH86D	GH86D	Tape & Reel
AZ1086H-5.0TRE1	AZ1086H-5.0TRG1	EH86F	GH86F	Tape & Reel		

BCD Semiconductor's Pb-free products, as designated with "E1" suffix in the part number, are RoHS compliant. Products with "G1" suffix are available in green packages.

**1.5A LOW DROPOUT LINEAR REGULATOR****AZ1086****Absolute Maximum Ratings (Note 1)**

Parameter	Symbol	Value		Unit
Operating Junction Temperature	T_J	150		°C
Storage Temperature Range	T_{STG}	-65 to 150		°C
Lead Temperature (Soldering, 10sec)	T_{LEAD}	260		°C
Thermal Resistance (Note 2)	θ_{JA}	TO-252-2 (1)/ TO-252-2 (3)/ TO-252-2 (4)	100	°C/W
		TO-263-3	60	
		TO-220-3	60	
		SOT-223	120	
ESD (Machine Model)	ESD	400		V

Note 1: Stresses greater than those listed under "Absolute Maximum Ratings" may cause permanent damage to the device. These are stress ratings only, and functional operation of the device at these or any other conditions beyond those indicated under "Recommended Operating Conditions" is not implied. Exposure to "Absolute Maximum Ratings" for extended periods may affect device reliability.

Note 2: Absolute maximum ratings indicate limits beyond which damage to the component may occur. Electrical specifications do not apply when operating the device outside of its operating ratings. The maximum allowable power dissipation is a function of the maximum junction temperature, $T_{J(max)}$, the junction-to-ambient thermal resistance, θ_{JA} , and the ambient temperature, T_A . The maximum allowable power dissipation at any ambient temperature is calculated using: $P_{D(max)} = (T_{J(max)} - T_A) / \theta_{JA}$. Exceeding the maximum allowable power dissipation will result in excessive die temperature, and the regulator will go into thermal shutdown.

Recommended Operating Conditions

Parameter	Symbol	Min	Max	Unit
Input Voltage	V_{IN}		15	V
Operating Junction Temperature Range	T_J	0	125	°C



1.5A LOW DROPOUT LINEAR REGULATOR

AZ1086

Electrical Characteristics

Typicals and limits appearing in normal type apply for $T_J = 25^\circ\text{C}$. Limits appearing in **Boldface** type apply over the entire junction temperature range for operation, 0°C to 125°C . ($P_D \leq$ maximum power dissipation, see Note 3.)

Parameter	Symbol	Conditions	Min	Typ	Max	Unit
Reference Voltage	V_{REF}	AZ1086-ADJ, $I_{OUT}=10\text{mA}$, $V_{IN}-V_{OUT}=2\text{V}$, $T_J=25^\circ\text{C}$, $10\text{mA} \leq I_{OUT} \leq 1.5\text{A}$, $1.4\text{V} \leq V_{IN}-V_{OUT} \leq 6\text{V}$	1.238 1.225	1.250 1.250	1.262 1.270	V
Output Voltage	V_{OUT}	AZ1086-1.5, $I_{OUT}=10\text{mA}$, $V_{IN}=3.5\text{V}$, $T_J=25^\circ\text{C}$, $10\text{mA} \leq I_{OUT} \leq 1.5\text{A}$, $3\text{V} \leq V_{IN} \leq 10\text{V}$	1.485 1.47	1.5 1.5	1.515 1.53	V
		AZ1086-1.8, $I_{OUT}=10\text{mA}$, $V_{IN}=3.8\text{V}$, $T_J=25^\circ\text{C}$, $10\text{mA} \leq I_{OUT} \leq 1.5\text{A}$, $3.2\text{V} \leq V_{IN} \leq 10\text{V}$	1.782 1.746	1.8 1.8	1.818 1.854	V
		AZ1086-2.5, $I_{OUT}=10\text{mA}$, $V_{IN}=4.5\text{V}$, $T_J=25^\circ\text{C}$, $10\text{mA} \leq I_{OUT} \leq 1.5\text{A}$, $3.9\text{V} \leq V_{IN} \leq 10\text{V}$	2.475 2.45	2.5 2.5	2.525 2.55	V
		AZ1086-3.0, $I_{OUT}=10\text{mA}$, $V_{IN}=4.5\text{V}$, $T_J=25^\circ\text{C}$, $10\text{mA} \leq I_{OUT} \leq 1.5\text{A}$, $4.9\text{V} \leq V_{IN} \leq 10\text{V}$	2.97 2.94	3.0 3.0	3.03 3.06	V
		AZ1086-3.3, $I_{OUT}=10\text{mA}$, $V_{IN}=5\text{V}$, $T_J=25^\circ\text{C}$, $10\text{mA} \leq I_{OUT} \leq 1.5\text{A}$, $4.75\text{V} \leq V_{IN} \leq 10\text{V}$	3.267 3.235	3.3 3.3	3.333 3.365	V
		AZ1086-5.0, $I_{OUT}=10\text{mA}$, $V_{IN}=7\text{V}$, $T_J=25^\circ\text{C}$, $10\text{mA} \leq I_{OUT} \leq 1.5\text{A}$, $6.5\text{V} \leq V_{IN} \leq 10\text{V}$	4.95 4.9	5 5	5.05 5.1	V
Line Regulation	ΔV_{OUT}	AZ1086-ADJ, $I_{OUT} = 10\text{mA}$, $1.5\text{V} \leq V_{IN}-V_{OUT} \leq 10\text{V}$		0.015 0.035	0.2 0.2	%
		AZ1086-1.5, $I_{OUT}=10\text{mA}$, $1.5\text{V} \leq V_{IN}-V_{OUT} \leq 10\text{V}$		0.3 0.6	6 6	mV
		AZ1086-1.8, $I_{OUT}=10\text{mA}$, $1.5\text{V} \leq V_{IN}-V_{OUT} \leq 10\text{V}$		0.3 0.6	6 6	mV
		AZ1086-2.5, $I_{OUT}=10\text{mA}$, $1.5\text{V} \leq V_{IN}-V_{OUT} \leq 10\text{V}$		0.3 0.6	6 6	mV
		AZ1086-3.0, $I_{OUT}=10\text{mA}$, $1.5\text{V} \leq V_{IN}-V_{OUT} \leq 10\text{V}$		0.3 0.6	6 6	mV
		AZ1086-3.3, $I_{OUT}=10\text{mA}$, $1.5\text{V} \leq V_{IN}-V_{OUT} \leq 10\text{V}$		0.5 1	10 10	mV
		AZ1086-5.0, $I_{OUT}=10\text{mA}$, $1.5\text{V} \leq V_{IN}-V_{OUT} \leq 10\text{V}$		0.5 1	10 10	mV
Thermal Resistance, Junction to Case	θ_{JC}	TO-220-3		7.22		$^\circ\text{C}/\text{W}$
		TO-252-2 (1)/TO-252-2 (3)/TO-252-2 (4)		12.81		
		TO-263-3		7.22		
		SOT-223		19.35		



1.5A LOW DROPOUT LINEAR REGULATOR

AZ1086

Electrical Characteristics (Continued)

Typicals and limits appearing in normal type apply for $T_J=25^{\circ}\text{C}$. Limits appearing in **Boldface** type apply over the entire junction temperature range for operation, 0°C to 125°C . ($P_D \leq$ maximum power dissipation, see Note 3.)

Parameter	Symbol	Conditions	Min	Typ	Max	Unit
Load Regulation	ΔV_{OUT}	AZ1086-ADJ, $10\text{mA} \leq I_{OUT} \leq 1.5\text{A}$, $V_{IN} - V_{OUT} = 2\text{V}$		0.1 0.2	0.3 0.4	%
		AZ1086-1.5, $10\text{mA} \leq I_{OUT} \leq 1.5\text{A}$, $V_{IN} - V_{OUT} = 2\text{V}$		3 6	12 20	mV
		AZ1086-1.8, $10\text{mA} \leq I_{OUT} \leq 1.5\text{A}$, $V_{IN} - V_{OUT} = 2\text{V}$		3 6	12 20	mV
		AZ1086-2.5, $10\text{mA} \leq I_{OUT} \leq 1.5\text{A}$, $V_{IN} - V_{OUT} = 2\text{V}$		3 6	12 20	mV
		AZ1086-3.0, $10\text{mA} \leq I_{OUT} \leq 1.5\text{A}$, $V_{IN} - V_{OUT} = 2\text{V}$		3 7	15 20	mV
		AZ1086-3.3, $10\text{mA} \leq I_{OUT} \leq 1.5\text{A}$, $V_{IN} - V_{OUT} = 2\text{V}$		3 7	15 20	mV
		AZ1086-5.0, $10\text{mA} \leq I_{OUT} \leq 1.5\text{A}$, $V_{IN} - V_{OUT} = 2\text{V}$		5 10	20 35	mV
Dropout Voltage	V_{DROP}	$I_{OUT} = 1.5\text{A}$, $\Delta V_{REF} = 1\%$		1.3	1.5	V
Current Limit	I_{LIMIT}	$V_{IN} - V_{OUT} = 2\text{V}$	1.5	2.3		A
Minimum Load Current	$I_{LOAD(MIN)}$	$1.4\text{V} \leq V_{IN} - V_{OUT} \leq 10\text{V}$ (For ADJ)		2	5	mA
Quiescent Current	I_Q	$V_{IN} = V_{OUT} + 1.3\text{V}$		5	10	mA
Ripple Rejection	PSRR	$f_{RIPPLE} = 120\text{Hz}$, $C_{OUT} = 25\mu\text{F}$ Tantalum, $I_{OUT} = 1.5\text{A}$, $V_{IN} - V_{OUT} = 3\text{V}$	60	75		dB
Adjust Pin Current	I_{ADJ}			60	120	μA
Adjust Pin Current Change	ΔI_{ADJ}	$10\text{mA} \leq I_{OUT} \leq 1.5\text{A}$, $1.4\text{V} \leq V_{IN} - V_{OUT} \leq 10\text{V}$		0.2	5	μA
Temperature Stability				0.5		%
RMS Noise (% of V_{OUT})		$T_A = 25^{\circ}\text{C}$, $10\text{Hz} \leq f \leq 10\text{kHz}$		0.003		%
Thermal Shutdown		Junction Temperature		165		$^{\circ}\text{C}$
Thermal Shutdown Hysteresis				30		$^{\circ}\text{C}$

Note 3: Maximum power dissipation see Figure 5.



1.5A LOW DROPOUT LINEAR REGULATOR

AZ1086

Typical Performance Characteristics

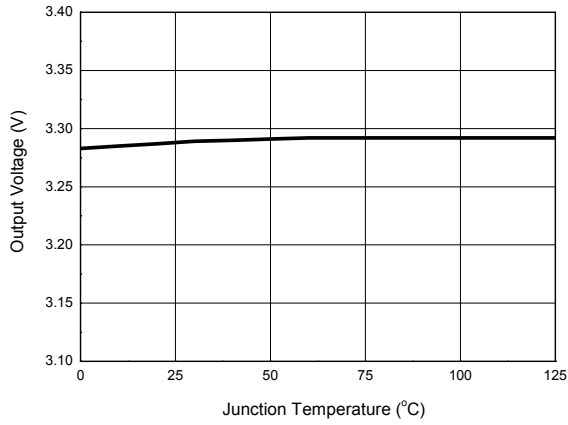

Figure 4. Output Voltage vs. Junction Temperature

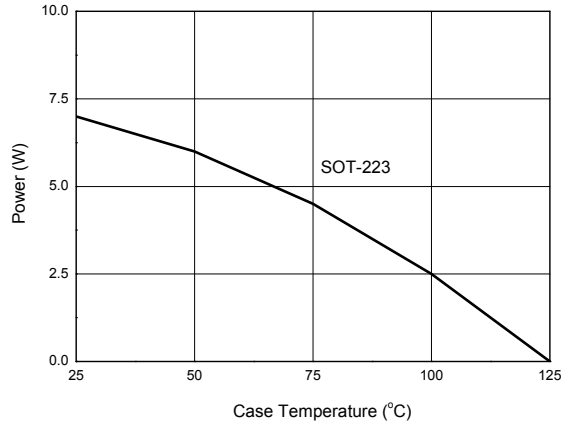

Figure 5. Maximum Power Dissipation

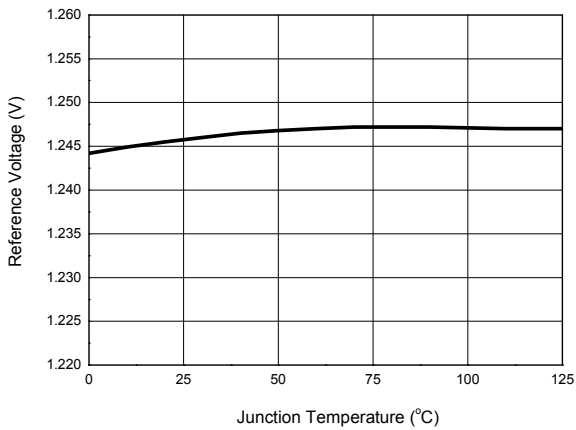

Figure 6. Reference Voltage vs. Junction Temperature

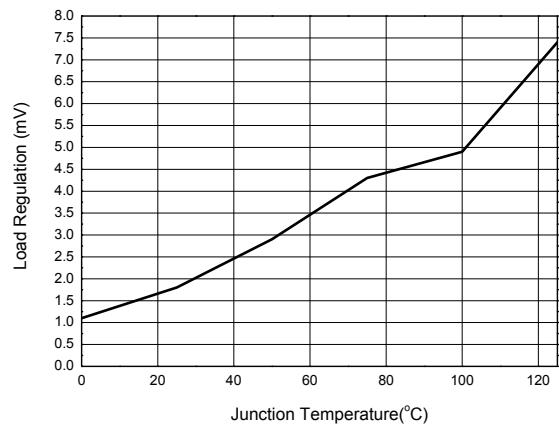

Figure 7. Load Regulation vs. Junction Temperature



1.5A LOW DROPOUT LINEAR REGULATOR

AZ1086

Typical Performance Characteristics (Continued)

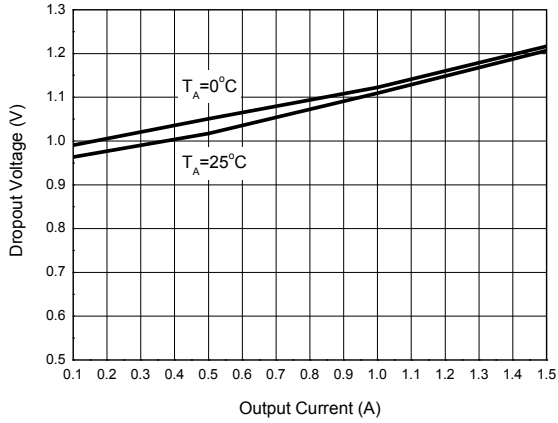

Figure 8. Dropout Voltage vs. Output Current

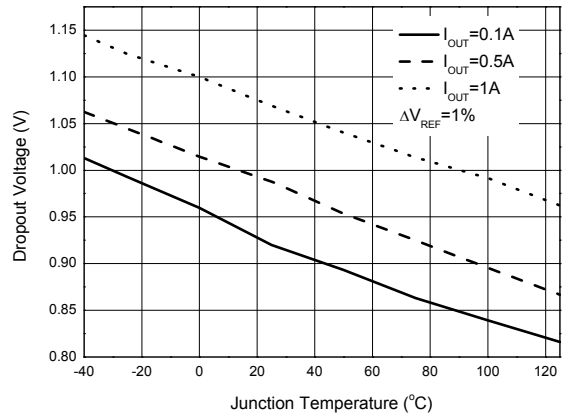

Figure 9. Dropout Voltage vs. Junction Temperature

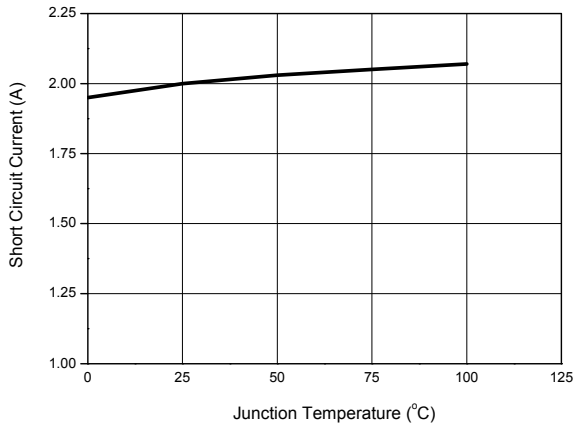

Figure 10. Short Circuit Current vs. Junction Temperature

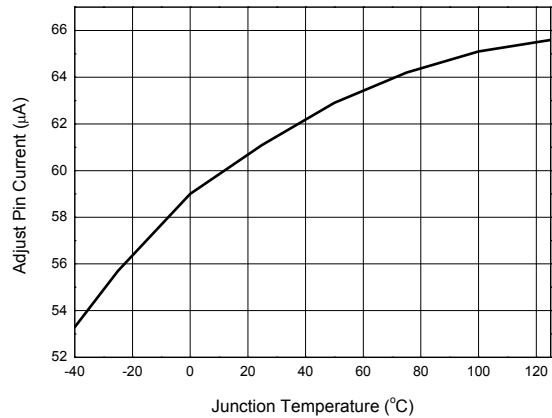

Figure 11. Adjust Pin Current vs. Junction Temperature



1.5A LOW DROPOUT LINEAR REGULATOR

AZ1086

Typical Performance Characteristics (Continued)

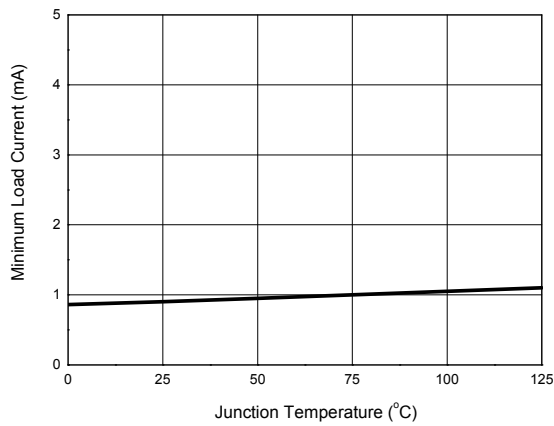

Figure 12. Minimum Load Current vs. Junction Temperature

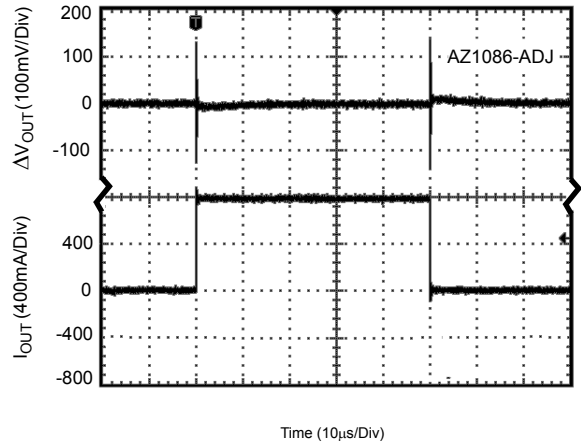

Figure 13. Load Transient Response
(Conditions: $V_{IN}=4.8V$, $V_{OUT}=3.3V$, $I_{OUT}=0.1$ to $0.75A$, $C_{IN}=C_{OUT}=10\mu F$)

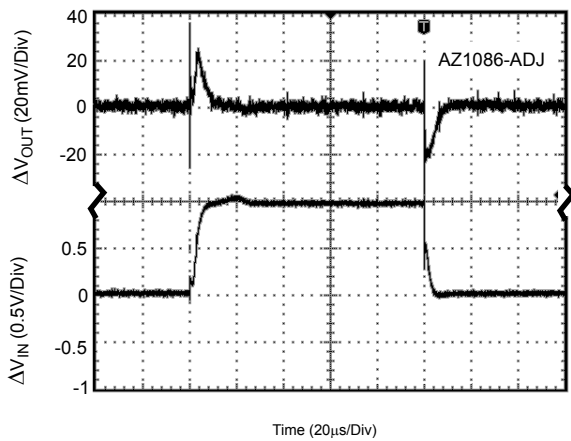

Figure 14. Line Transient Response
(Conditions: $V_{IN}=4.8V$ to $5.8V$, $V_{OUT}=3.3V$, $I_{OUT}=0.1A$, $C_{IN}=1\mu F$, $C_{OUT}=10\mu F$)

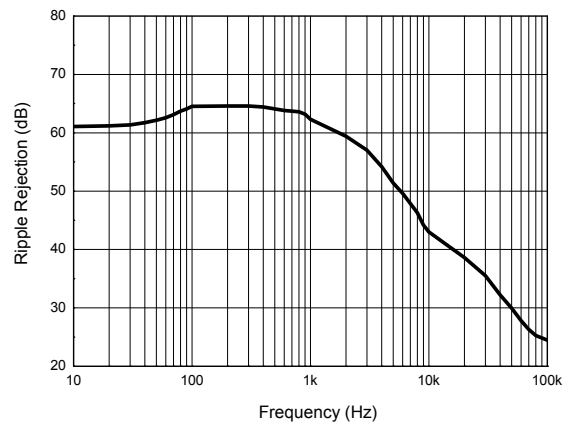

Figure 15. Ripple Rejection vs. Frequency

1.5A LOW DROPOUT LINEAR REGULATOR

AZ1086

Typical Application

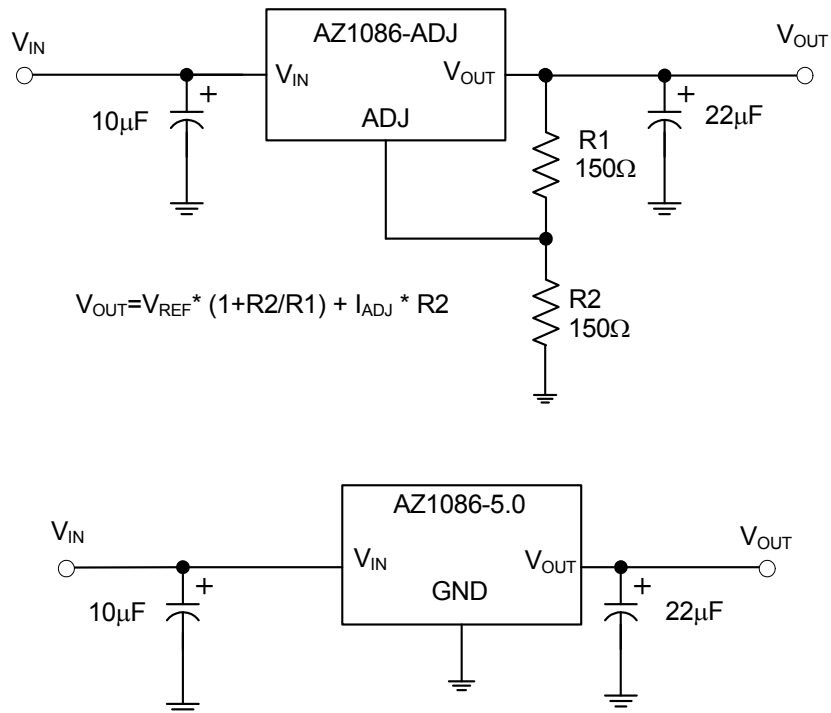

Figure 16. Typical Applications of AZ1086



1.5A LOW DROPOUT LINEAR REGULATOR

AZ1086

Mechanical Dimensions

TO-263-3

Unit: mm(inch)

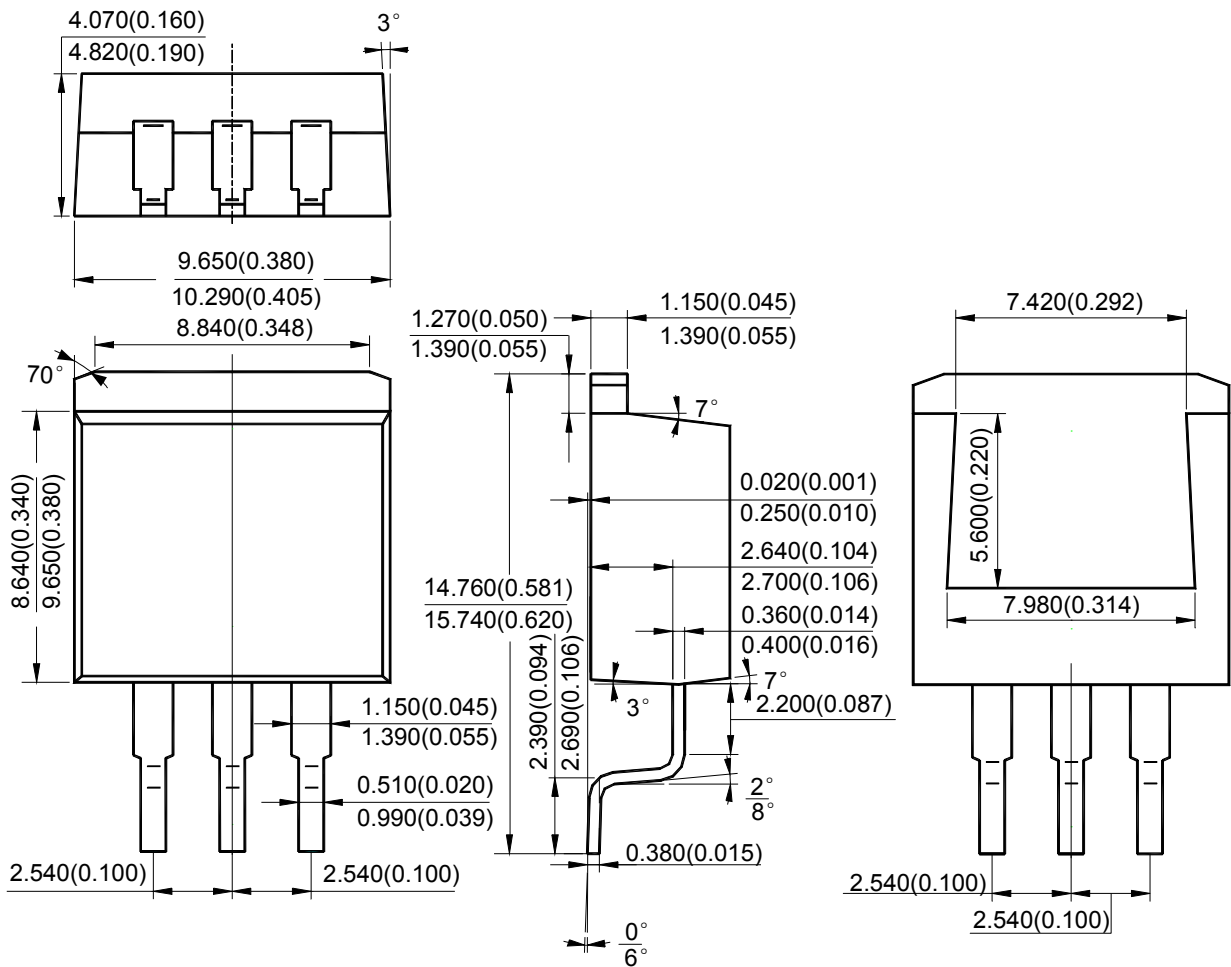



1.5A LOW DROPOUT LINEAR REGULATOR

AZ1086

Mechanical Dimensions (Continued)

TO-220-3

Unit: mm(inch)

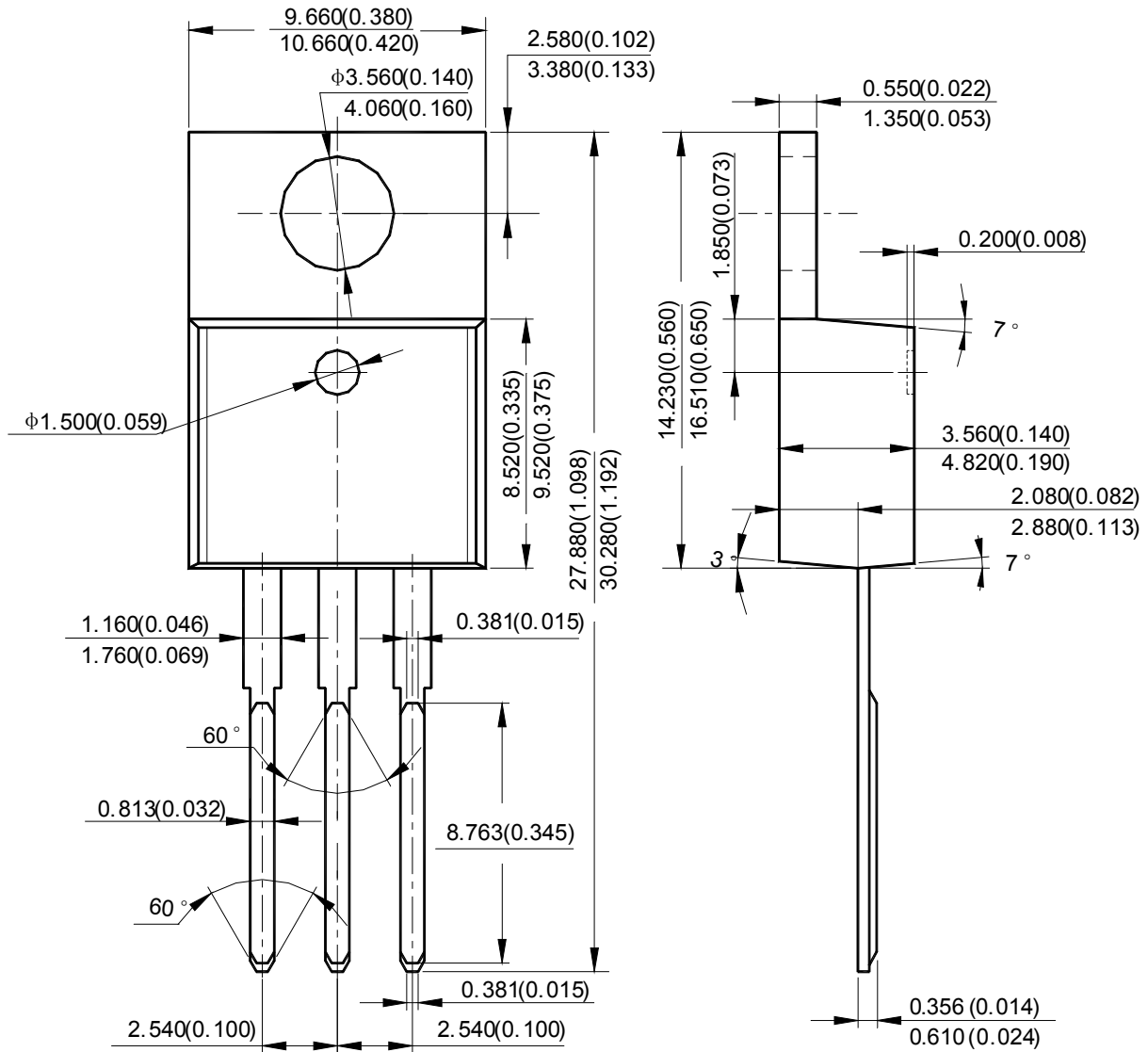



1.5A LOW DROPOUT LINEAR REGULATOR

AZ1086

Mechanical Dimensions (Continued)

SOT-223

Unit: mm(inch)

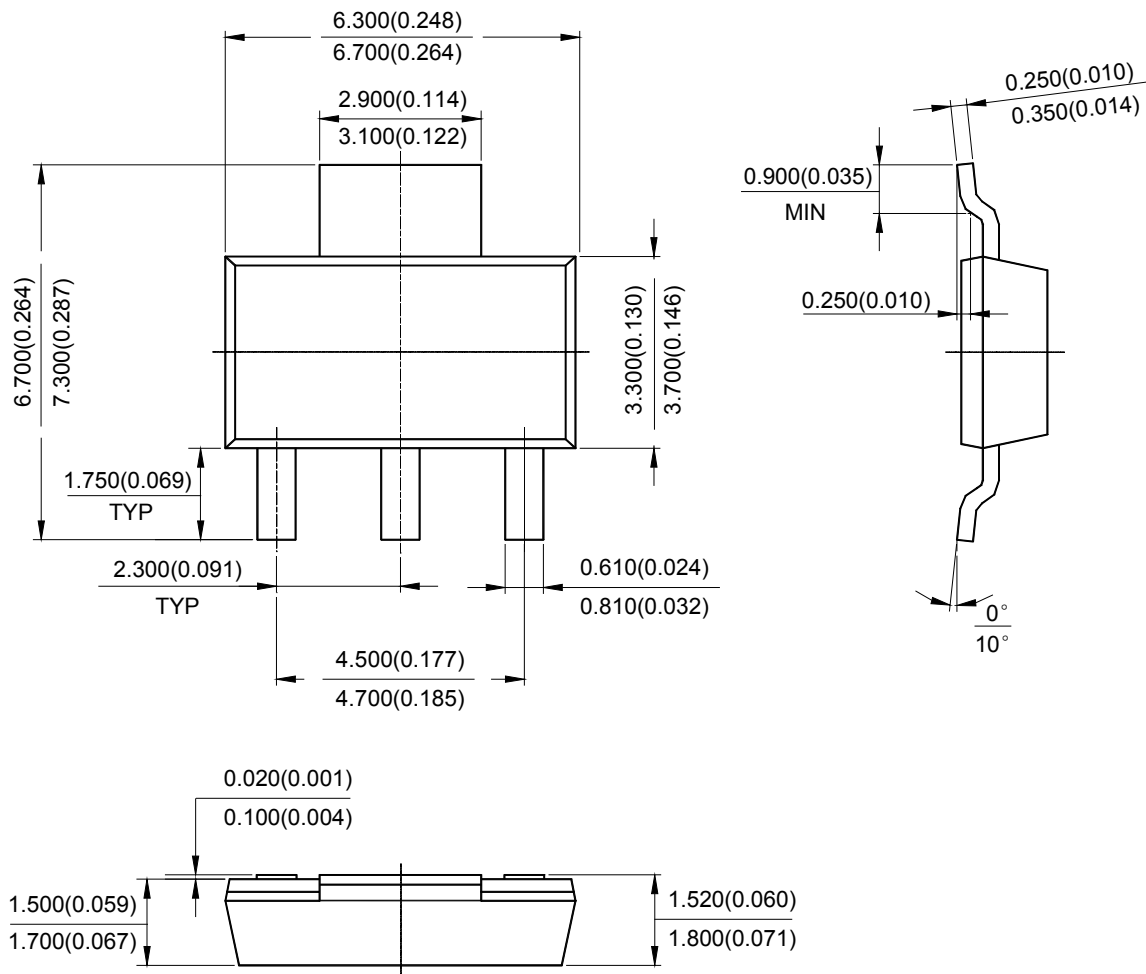



1.5A LOW DROPOUT LINEAR REGULATOR

AZ1086

Mechanical Dimensions (Continued)

TO-252-2 (1)

Unit: mm(inch)

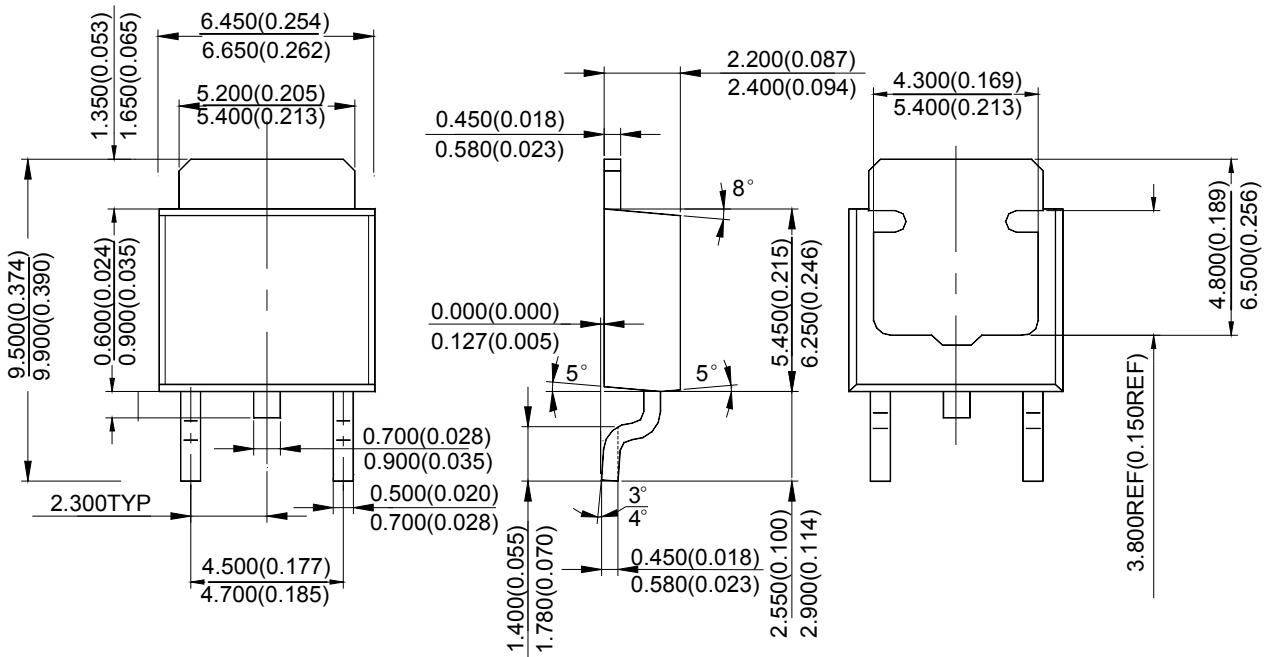



1.5A LOW DROPOUT LINEAR REGULATOR

AZ1086

Mechanical Dimensions (Continued)

TO-252-2 (3)

Unit: mm(inch)

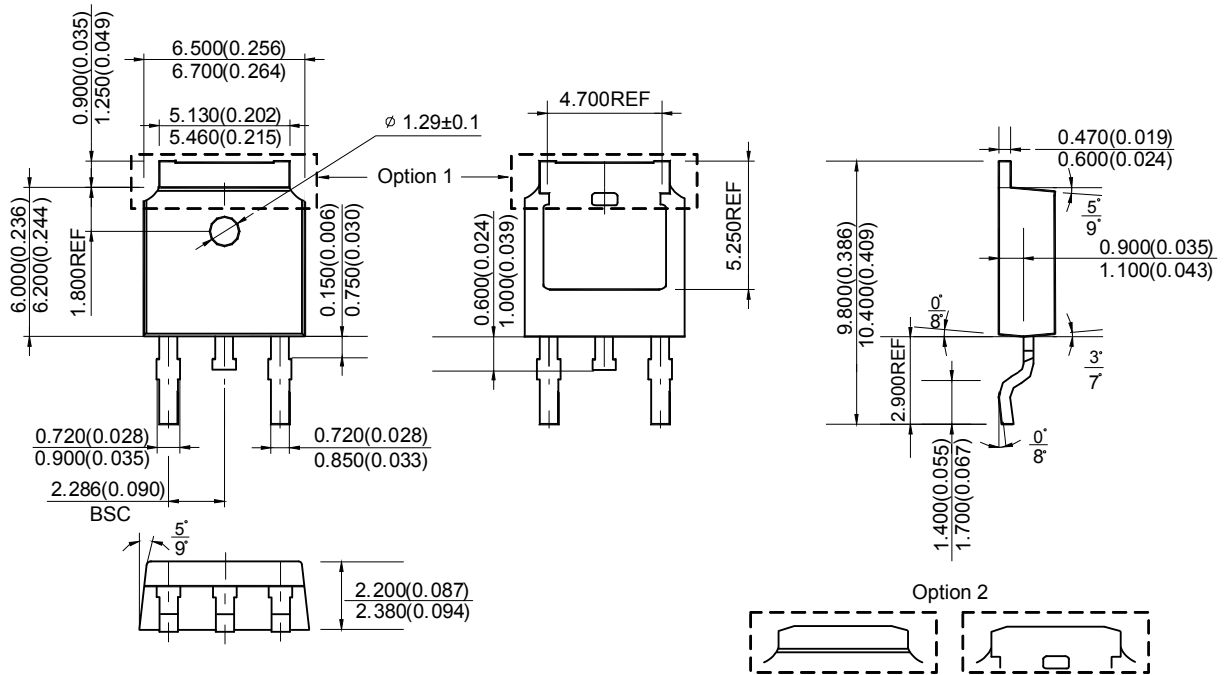



1.5A LOW DROPOUT LINEAR REGULATOR

AZ1086

Mechanical Dimensions (Continued)

TO-252-2 (4)

Unit: mm(inch)

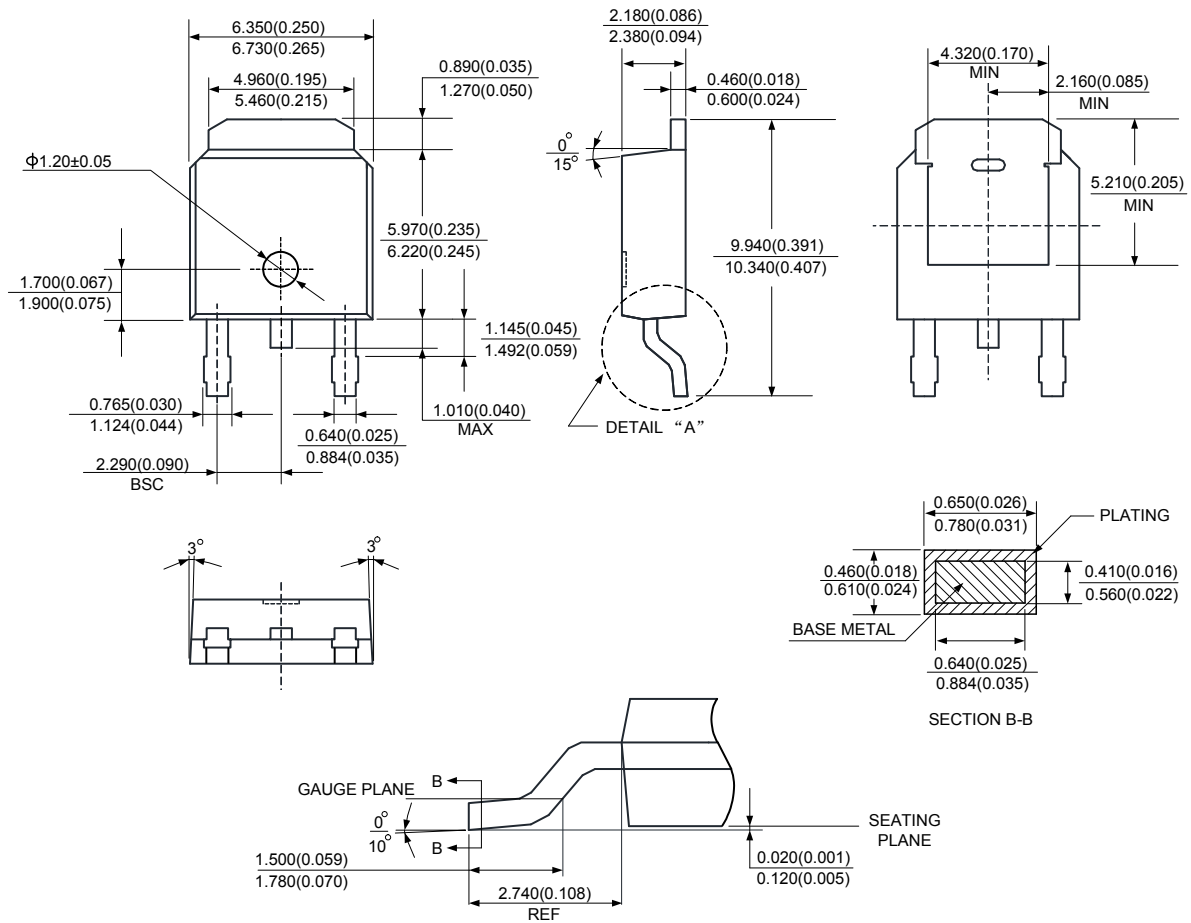



BCD Semiconductor Manufacturing Limited

<http://www.bcdsemi.com>

IMPORTANT NOTICE

BCD Semiconductor Manufacturing Limited reserves the right to make changes without further notice to any products or specifications herein. BCD Semiconductor Manufacturing Limited does not assume any responsibility for use of any its products for any particular purpose, nor does BCD Semiconductor Manufacturing Limited assume any liability arising out of the application or use of any its products or circuits. BCD Semiconductor Manufacturing Limited does not convey any license under its patent rights or other rights nor the rights of others.

MAIN SITE

- Headquarters

BCD Semiconductor Manufacturing Limited

No. 1600, Zi Xing Road, Shanghai Zizhu Science-based Industrial Park, 200241, China
Tel: +86-21-24162266, Fax: +86-21-24162277

- Wafer Fab

Shanghai SIM-BCD Semiconductor Manufacturing Co., Ltd.

800 Yi Shan Road, Shanghai 200233, China
Tel: +86-21-6485 1491, Fax: +86-21-5450 0008

REGIONAL SALES OFFICE

Shenzhen Office

Shanghai SIM-BCD Semiconductor Manufacturing Co., Ltd., Shenzhen Office

Unit A Room 1203, Skyworth Bldg., Gaoxin Ave. 1.S., Nanshan District, Shenzhen, China
Tel: +86-755-8826 7951
Fax: +86-755-8826 7865

Taiwan Office

BCD Semiconductor (Taiwan) Company Limited

4F, 298-1, Rui Guang Road, Nei-Hu District, Taipei, Taiwan
Tel: +886-2-2656 2808
Fax: +886-2-2656 2806

USA Office

BCD Semiconductor Corp.

30920 Huntwood Ave. Hayward, CA 94544, USA
Tel : +1-510-324-2988
Fax: +1-510-324-2788