



Chipsmall Limited consists of a professional team with an average of over 10 year of expertise in the distribution of electronic components. Based in Hongkong, we have already established firm and mutual-benefit business relationships with customers from,Europe,America and south Asia,supplying obsolete and hard-to-find components to meet their specific needs.

With the principle of “Quality Parts,Customers Priority,Honest Operation,and Considerate Service”,our business mainly focus on the distribution of electronic components. Line cards we deal with include Microchip,ALPS,ROHM,Xilinx,Pulse,ON,Everlight and Freescale. Main products comprise IC,Modules,Potentiometer,IC Socket,Relay,Connector.Our parts cover such applications as commercial,industrial, and automotives areas.

We are looking forward to setting up business relationship with you and hope to provide you with the best service and solution. Let us make a better world for our industry!



Contact us

Tel: +86-755-8981 8866 Fax: +86-755-8427 6832

Email & Skype: info@chipsmall.com Web: www.chipsmall.com

Address: A1208, Overseas Decoration Building, #122 Zhenhua RD., Futian, Shenzhen, China



Description

The AZ1117I is available in industrial temperature range low dropout three-terminal regulator.

The AZ1117I is optimized for low voltage where transient response and minimum input voltage are critical. It provides current limit and thermal shutdown. Its circuit includes a trimmed bandgap reference to assure output voltage accuracy to be within $\pm 1\%$. On-chip thermal shutdown provides protection against a combination of high current and ambient temperature that would create excessive junction temperature.

The AZ1117I is available in 1.2V, 1.5V, 1.8V, 2.5V, 3.3V, 5.0V fixed output voltage versions and ADJ output voltage version. The fixed versions integrate the adjust resistors. It is also available in an adjustable version which can set the output voltage with two external resistors.

The AZ1117I is available in the industry-standard SOT223 and TO252-2 power packages.

Features

- Current Limit: 1.35A (Typ)
- Output Noise from 10Hz to 10KHz: 0.003% of V_{OUT}
- PSRR at $I_{OUT} = 300\text{mA}$ and $f = 120\text{Hz}$: 70dB
- Output Voltage Accuracy: $\pm 1\%$ (Except 1.2V Version)
- On-chip Thermal Shutdown
- Maximum Quiescent Current: $I_{QMAX} = 6\text{mA}$
- Compatible with Low ESR Ceramic Capacitor
- Operation Junction Temperature: -40°C to $+125^\circ\text{C}$
- **Totally Lead-Free & Fully RoHS Compliant (Notes 1 & 2)**
- **Halogen and Antimony Free. "Green" Device (Note 3)**

- Notes:
1. No purposely added lead. Fully EU Directive 2002/95/EC (RoHS) & 2011/65/EU (RoHS 2) compliant.
 2. See http://www.diodes.com/quality/lead_free.html for more information about Diodes Incorporated's definitions of Halogen- and Antimony-free, "Green" and Lead-free.
 3. Halogen- and Antimony-free "Green" products are defined as those which contain <900ppm bromine, <900ppm chlorine (<1500ppm total Br + Cl) and <1000ppm antimony compounds.

Pin Assignments

(Top View)

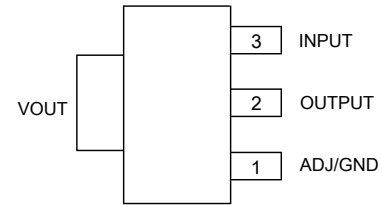

SOT223

(Top View)

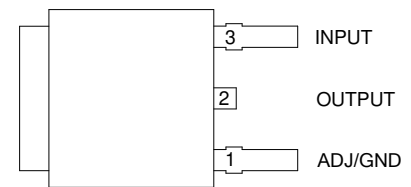

TO252-2

Applications

- USB Device
- Add-on Card
- DVD Player
- PC Motherboard

Typical Applications Circuit (Note 4)

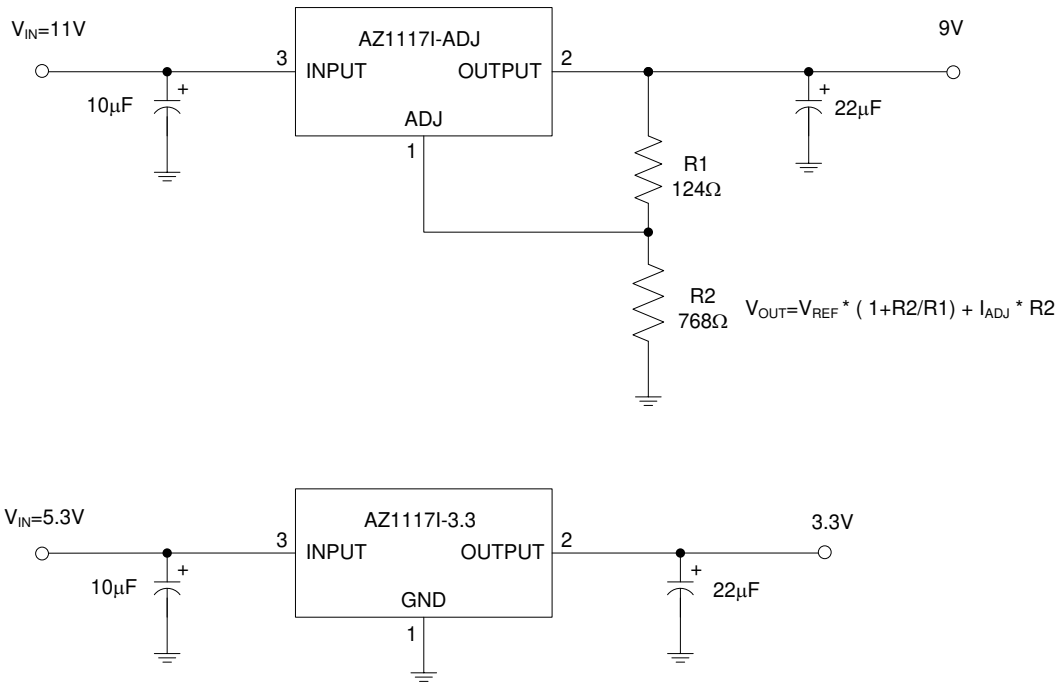

Note 4: The AZ1117I is compatible with low ESR ceramic capacitor.
The ESR of the output capacitors must be less than 20Ω.
A minimum of 10µF output capacitor is required.

Functional Block Diagram

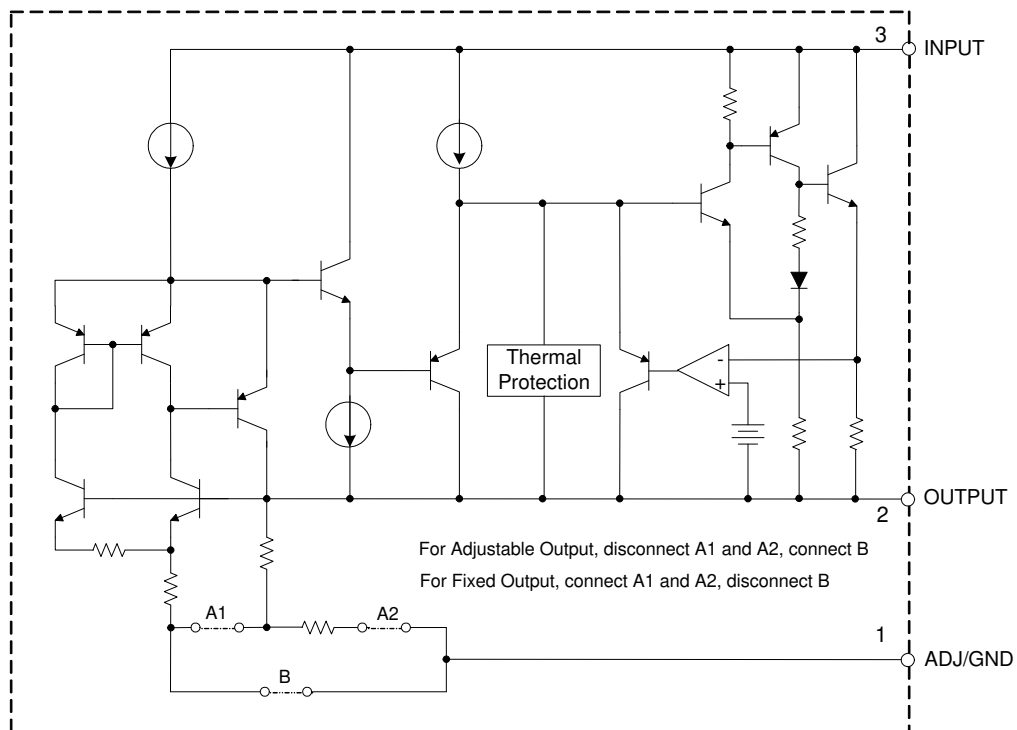

Absolute Maximum Ratings (Note 5) (@ $T_A = +25^\circ\text{C}$, unless otherwise specified.)

Symbol	Parameter	Rating		Unit
V_{IN}	Input Voltage	18		V
T_J	Operating Junction Temperature Range	+150		$^\circ\text{C}$
T_{STG}	Storage Temperature Range	-65 to +150		$^\circ\text{C}$
θ_{JA}	Thermal Resistance (Without Heatsink)	SOT223	125	$^\circ\text{C}/\text{W}$
		TO252-2	100	
θ_{JA}	Thermal Resistance (With Heatsink) (Note 6)	SOT223	100	$^\circ\text{C}/\text{W}$
		TO252-2	70	
T_{LEAD}	Lead Temperature (Soldering, 10sec)	+260		$^\circ\text{C}$

Notes: 5. Stresses greater than those listed under "Absolute Maximum Ratings" may cause permanent damage to the device. These are stress ratings only, and functional operation of the device at these or any other conditions beyond those indicated under "Recommended Operating Conditions" is not implied. Exposure to "Absolute Maximum Ratings" for extended periods may affect device reliability.
 6. Chip is soldered to 100mm² (10mm*10mm) copper (top side solder mask) on 2oz.2 layers FR-4 PCB with 8*0.5mm vias.

Recommended Operating Conditions (@ $T_A = +25^\circ\text{C}$, unless otherwise specified.)

Symbol	Parameter	Min	Max	Unit
V_{IN}	Input Voltage	—	15	V
T_J	Operating Junction Temperature Range	-40	+125	$^\circ\text{C}$

Electrical Characteristics AZ1117I-ADJ

(Operating Conditions: $V_{IN} = V_{OUT} + 2\text{V}$, $I_{OUT} = 10\text{mA}$, $T_J = +25^\circ\text{C}$, unless otherwise specified. ($P \leq$ maximum power dissipation). Limits appearing in **Boldface** type apply over the entire junction temperature range for operation, -40°C to $+125^\circ\text{C}$.)

Symbol	Parameter	Conditions	Min	Typ	Max	Unit	
V_{REF}	Reference Voltage	$1.5\text{V} \leq V_{IN} - V_{OUT} \leq 10\text{V}$	1.238	1.250	1.262	V	
			1.225	1.250	1.275		
V_{RLINE}	Line Regulation	$1.5\text{V} \leq V_{IN} - V_{OUT} \leq 10\text{V}$	—	0.001	0.1	%	
			—	—	0.2		
V_{RLOAD}	Load Regulation	$V_{IN} = V_{OUT} + 2\text{V}$ $1\text{mA} \leq I_{OUT} \leq 1\text{A}$	—	0.4	1.0	%	
V_{DROP}	Dropout Voltage	$\Delta V_{REF} = 1\%$, $I_{OUT} = 0.8\text{A}$	SOT223	—	1.2	1.3	V
			TO252-2	—	1.3	1.4	V
I_{LIMIT}	Current Limit	—	1	1.35	—	A	
—	Adjust Pin Current	—	—	60	120	μA	
—	Adjust Pin Current Change	$1.5 \leq (V_{IN} - V_{OUT}) \leq 10\text{V}$	—	0.2	5	μA	
—	Minimum Load Current	$1.5 \leq (V_{IN} - V_{OUT}) \leq 10\text{V}$	—	1.7	5	mA	
PSRR	Ripple Rejection	$f = 120\text{Hz}$, $C_{OUT} = 22\mu\text{F}$ $(V_{IN} - V_{OUT}) = 3\text{V}$, $I_{OUT} = 300\text{mA}$	—	70	—	dB	
—	Temperature Stability	—	—	0.5	—	%	
—	RMS Output Noise (% of V_{OUT})	$T_A = +25^\circ\text{C}$, $10\text{Hz} \leq f \leq 10\text{KHz}$	—	0.003	—	%	
—	Thermal Shutdown	Junction Temperature	—	+160	—	$^\circ\text{C}$	
—	Thermal Shutdown Hysteresis	—	—	+16	—	$^\circ\text{C}$	
θ_{JC}	Thermal Resistance (Junction to Case)	SOT223	—	15	—	$^\circ\text{C}/\text{W}$	
		TO252-2	—	10	—		

Electrical Characteristics AZ1117I-1.2 (Cont.)

(Operating Conditions: $V_{IN} \leq 10V$, $I_{OUT} = 10mA$, $T_J = +25^\circ C$, unless otherwise specified. ($P \leq$ maximum power dissipation). Limits appearing in **Boldface** type apply over the entire junction temperature range for operation, $-40^\circ C$ to $+125^\circ C$.)

Symbol	Parameter	Conditions	Min	Typ	Max	Unit	
V_{OUT}	Output Voltage	$1.5V \leq V_{IN} - V_{OUT} \leq 10V$	1.176	1.2	1.224	V	
			1.152	1.2	1.248		
V_{RLINE}	Line Regulation	$1.5V \leq V_{IN} - V_{OUT} \leq 10V$	—	0.5	6	mV	
			—	—	10		
V_{RLOAD}	Load Regulation	$V_{IN} = V_{OUT} + 2V$ $1mA \leq I_{OUT} \leq 1A$	—	2	15	mV	
V_{DROP}	Dropout Voltage	$\Delta V_{OUT} = 1\%$, $I_{OUT} = 0.8A$	SOT223	—	1.2	1.3	V
			TO252-2	—	1.3	1.4	V
I_{LIMIT}	Current Limit	—	1	1.35	—	A	
I_Q	Quiescent Current	$I_{OUT} = 0$	—	4	6	mA	
PSRR	Ripple Rejection	$f = 120Hz$, $C_{OUT} = 22\mu F$ $(V_{IN} - V_{OUT}) = 3V$, $I_{OUT} = 300mA$	—	70	—	dB	
—	Temperature Stability	—	—	0.5	—	%	
—	RMS Output Noise (% of V_{OUT})	$T_A = +25^\circ C$, $10Hz \leq f \leq 10KHz$	—	0.003	—	%	
—	Thermal Shutdown	Junction Temperature	—	+160	—	$^\circ C$	
—	Thermal Shutdown Hysteresis	—	—	+16	—	$^\circ C$	
θ_{JC}	Thermal Resistance (Junction to Case)	SOT223	—	15	—	$^\circ C/W$	
		TO252-2	—	10	—		

Electrical Characteristics AZ1117I-1.5 (Cont.)

(Operating Conditions: $V_{IN} \leq 10V$, $I_{OUT} = 10mA$, $T_J = +25^\circ C$, unless otherwise specified. ($P \leq$ maximum power dissipation). Limits appearing in **Boldface** type apply over the entire junction temperature range for operation, $-40^\circ C$ to $+125^\circ C$.)

Symbol	Parameter	Conditions	Min	Typ	Max	Unit	
V_{OUT}	Output Voltage	$1.5V \leq V_{IN} - V_{OUT} \leq 10V$	1.485	1.5	1.515	V	
			1.47	1.5	1.53		
V_{RLINE}	Line Regulation	$1.5V \leq V_{IN} - V_{OUT} \leq 10V$	—	0.5	6	mV	
			—	—	10		
V_{RLOAD}	Load Regulation	$V_{IN} = V_{OUT} + 2V$ $1mA \leq I_{OUT} \leq 1A$	—	2	15	mV	
V_{DROP}	Dropout Voltage	$\Delta V_{OUT} = 1\%$, $I_{OUT} = 0.8A$	SOT223	—	1.2	1.3	V
			TO252-2	—	1.3	1.4	V
I_{LIMIT}	Current Limit	—	1	1.35	—	A	
I_Q	Quiescent Current	$I_{OUT} = 0$	—	4	6	mA	
PSRR	Ripple Rejection	$f = 120Hz$, $C_{OUT} = 22\mu F$ $(V_{IN} - V_{OUT}) = 3V$, $I_{OUT} = 300mA$	—	70	—	dB	
—	Temperature Stability	—	—	0.5	—	%	
—	RMS Output Noise (% of V_{OUT})	$T_A = +25^\circ C$, $10Hz \leq f \leq 10KHz$	—	0.003	—	%	
—	Thermal Shutdown	Junction Temperature	—	+160	—	$^\circ C$	
—	Thermal Shutdown Hysteresis	—	—	+16	—	$^\circ C$	
θ_{JC}	Thermal Resistance (Junction to Case)	SOT223	—	15	—	$^\circ C/W$	
		TO252-2	—	10	—		

Electrical Characteristics AZ1117I-1.8 (Cont.)

(Operating Conditions: $V_{IN} \leq 10V$, $I_{OUT} = 10mA$, $T_J = +25^\circ C$, unless otherwise specified. ($P \leq$ maximum power dissipation). Limits appearing in **Boldface** type apply over the entire junction temperature range for operation, $-40^\circ C$ to $+125^\circ C$.)

Symbol	Parameter	Conditions	Min	Typ	Max	Unit	
V_{OUT}	Output Voltage	$1.5V \leq V_{IN} - V_{OUT} \leq 10V$	1.782	1.8	1.818	V	
			1.764	1.8	1.836		
V_{RLINE}	Line Regulation	$1.5V \leq V_{IN} - V_{OUT} \leq 10V$	—	0.5	6	mV	
			—	—	10		
V_{RLOAD}	Load Regulation	$V_{IN} = V_{OUT} + 2V$ $1mA \leq I_{OUT} \leq 1A$	—	2	15	mV	
V_{DROP}	Dropout Voltage	$\Delta V_{OUT} = 1\%$, $I_{OUT} = 0.8A$	SOT223	—	1.2	1.3	V
			TO252-2	—	1.3	1.4	V
I_{LIMIT}	Current Limit	—	1	1.35	—	A	
I_Q	Quiescent Current	$I_{OUT} = 0$	—	4	6	mA	
PSRR	Ripple Rejection	$f = 120Hz$, $C_{OUT} = 22\mu F$ $(V_{IN} - V_{OUT}) = 3V$, $I_{OUT} = 300mA$	—	70	—	dB	
—	Temperature Stability	—	—	0.5	—	%	
—	RMS Output Noise (% of V_{OUT})	$T_A = +25^\circ C$, $10Hz \leq f \leq 10KHz$	—	0.003	—	%	
—	Thermal Shutdown	Junction Temperature	—	+160	—	$^\circ C$	
—	Thermal Shutdown Hysteresis	—	—	+16	—	$^\circ C$	
θ_{JC}	Thermal Resistance (Junction to Case)	SOT223	—	15	—	$^\circ C/W$	
		TO252-2	—	10	—		

NEW PRODUCT
Electrical Characteristics AZ1117I-2.5 (Cont.)

(Operating Conditions: $V_{IN} \leq 10V$, $I_{OUT} = 10mA$, $T_J = +25^\circ C$, unless otherwise specified. ($P \leq$ maximum power dissipation). Limits appearing in **Boldface** type apply over the entire junction temperature range for operation, $-40^\circ C$ to $+125^\circ C$.)

Symbol	Parameter	Conditions	Min	Typ	Max	Unit	
V_{OUT}	Output Voltage	$1.5V \leq V_{IN} - V_{OUT} \leq 10V$	2.475	2.5	2.525	V	
			2.455	2.5	2.545		
V_{RLINE}	Line Regulation	$1.5V \leq V_{IN} - V_{OUT} \leq 10V$	—	0.5	6	mV	
			—	—	10		
V_{RLOAD}	Load Regulation	$V_{IN} = V_{OUT} + 2V$ $1mA \leq I_{OUT} \leq 1A$	—	2	15	mV	
V_{DROP}	Dropout Voltage	$\Delta V_{OUT} = 1\%$, $I_{OUT} = 0.8A$	SOT223	—	1.2	1.3	V
			TO252-2	—	1.3	1.4	V
I_{LIMIT}	Current Limit	—	1	1.35	—	A	
I_Q	Quiescent Current	$I_{OUT} = 0$	—	4	6	mA	
PSRR	Ripple Rejection	$f = 120Hz$, $C_{OUT} = 22\mu F$ $(V_{IN} - V_{OUT}) = 3V$, $I_{OUT} = 300mA$	—	70	—	dB	
—	Temperature Stability	—	—	0.5	—	%	
—	RMS Output Noise (% of V_{OUT})	$T_A = +25^\circ C$, $10Hz \leq f \leq 10KHz$	—	0.003	—	%	
—	Thermal Shutdown	Junction Temperature	—	+160	—	$^\circ C$	
—	Thermal Shutdown Hysteresis	—	—	+16	—	$^\circ C$	
θ_{JC}	Thermal Resistance (Junction to Case)	SOT223	—	15	—	$^\circ C/W$	
		TO252-2	—	10	—		

Electrical Characteristics AZ1117I-3.3 (Cont.)

(Operating Conditions: $V_{IN} \leq 10V$, $I_{OUT} = 10mA$, $T_J = +25^\circ C$, unless otherwise specified. ($P \leq$ maximum power dissipation). Limits appearing in **Boldface** type apply over the entire junction temperature range for operation, $-40^\circ C$ to $+125^\circ C$.)

Symbol	Parameter	Conditions	Min	Typ	Max	Unit	
V_{OUT}	Output Voltage	$1.5V \leq V_{IN} - V_{OUT} \leq 10V$	3.267	3.3	3.333	V	
			3.235	3.3	3.365		
V_{RLINE}	Line Regulation	$1.5V \leq V_{IN} - V_{OUT} \leq 10V$	—	0.5	6	mV	
			—	—	10		
V_{RLOAD}	Load Regulation	$V_{IN} = V_{OUT} + 2V$ $1mA \leq I_{OUT} \leq 1A$	—	2	15	mV	
V_{DROP}	Dropout Voltage	$\Delta V_{OUT} = 1\%$, $I_{OUT} = 0.8A$	SOT223	—	1.2	1.3	V
			TO252-2	—	1.3	1.4	V
I_{LIMIT}	Current Limit	—	1	1.35	—	A	
I_Q	Quiescent Current	$I_{OUT} = 0$	—	4	6	mA	
PSRR	Ripple Rejection	$f = 120Hz$, $C_{OUT} = 22\mu F$ $(V_{IN} - V_{OUT}) = 3V$, $I_{OUT} = 300mA$	—	70	—	dB	
—	Temperature Stability	—	—	0.5	—	%	
—	RMS Output Noise (% of V_{OUT})	$T_A = +25^\circ C$, $10Hz \leq f \leq 10KHz$	—	0.003	—	%	
—	Thermal Shutdown	Junction Temperature	—	+160	—	$^\circ C$	
—	Thermal Shutdown Hysteresis	—	—	+16	—	$^\circ C$	
θ_{JC}	Thermal Resistance (Junction to Case)	SOT223	—	15	—	$^\circ C/W$	
		TO252-2	—	10	—		

Electrical Characteristics AZ1117I-5.0 (Cont.)

(Operating Conditions: $V_{IN} \leq 10V$, $I_{OUT} = 10mA$, $T_J = +25^\circ C$, unless otherwise specified. ($P \leq$ maximum power dissipation). Limits appearing in **Boldface** type apply over the entire junction temperature range for operation, $-40^\circ C$ to $+125^\circ C$.)

Symbol	Parameter	Conditions	Min	Typ	Max	Unit	
V_{OUT}	Output Voltage	$1.5V \leq V_{IN} - V_{OUT} \leq 10V$	4.950	5.0	5.050	V	
			4.900	5.0	5.100		
V_{RLINE}	Line Regulation	$1.5V \leq V_{IN} - V_{OUT} \leq 10V$	—	0.5	6	mV	
			—	—	10		
V_{RLOAD}	Load Regulation	$V_{IN} = V_{OUT} + 2V$ $1mA \leq I_{OUT} \leq 1A$	—	2	15	mV	
V_{DROP}	Dropout Voltage	$\Delta V_{OUT} = 1\%$, $I_{OUT} = 0.8A$	SOT223	—	1.2	1.3	V
			TO252-2	—	1.3	1.4	V
I_{LIMIT}	Current Limit	—	1	1.35	—	A	
I_Q	Quiescent Current	$I_{OUT} = 0$	—	4	6	mA	
PSRR	Ripple Rejection	$f = 120Hz$, $C_{OUT} = 22\mu F$ $(V_{IN} - V_{OUT}) = 3V$, $I_{OUT} = 300mA$	—	70	—	dB	
—	Temperature Stability	—	—	0.5	—	%	
—	RMS Output Noise (% of V_{OUT})	$T_A = +25^\circ C$, $10Hz \leq f \leq 10KHz$	—	0.003	—	%	
—	Thermal Shutdown	Junction Temperature	—	+160	—	$^\circ C$	
—	Thermal Shutdown Hysteresis	—	—	+16	—	$^\circ C$	
θ_{JC}	Thermal Resistance (Junction to Case)	SOT223	—	15	—	$^\circ C/W$	
		TO252-2	—	10	—		

Performance Characteristics

NEW PRODUCT

Line Regulation vs. Temperature

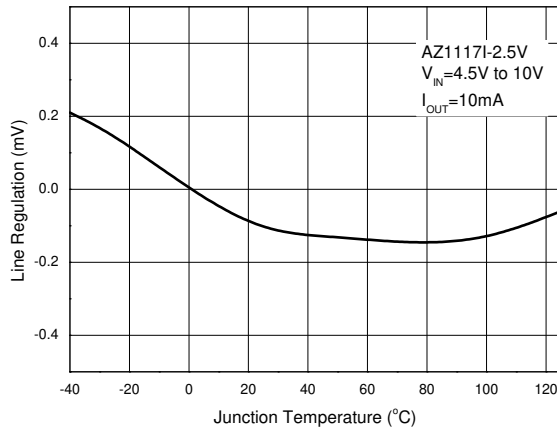

Load Regulation vs. Temperature

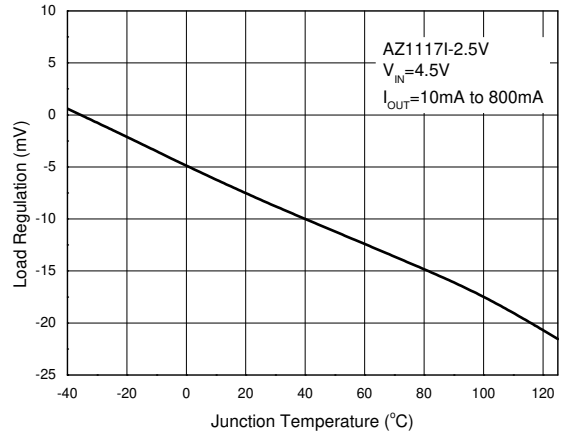

Reference Voltage vs. Temperature

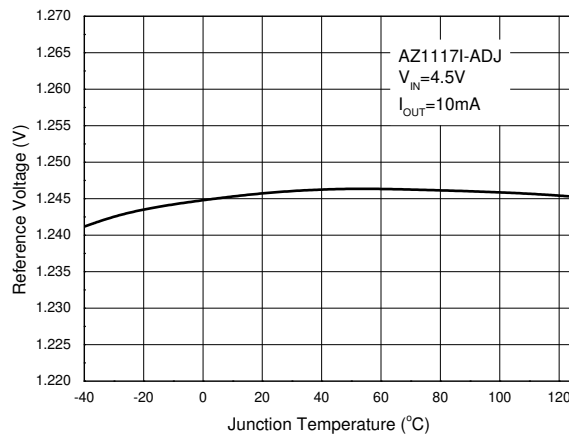

Output Voltage vs. Temperature

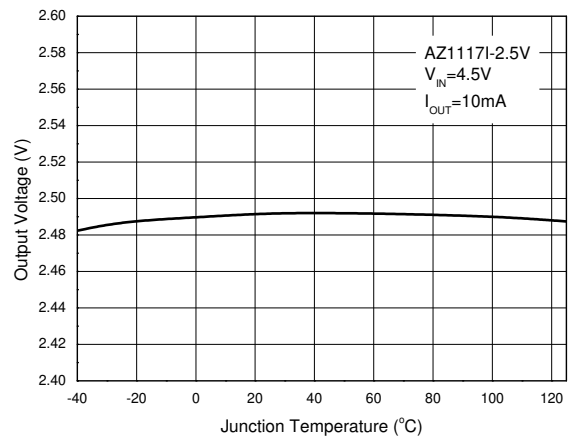

Minimum Load Current vs. Temperature

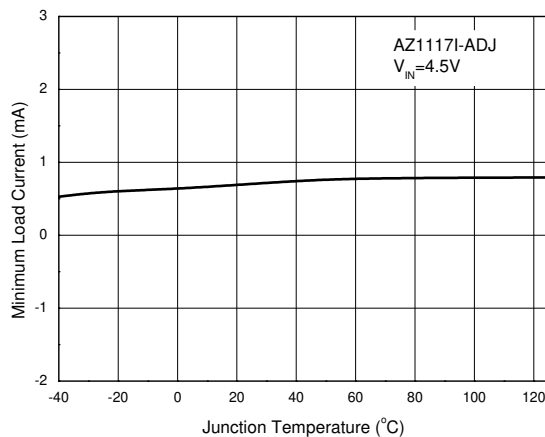

Adjust Pin Current vs. Temperature

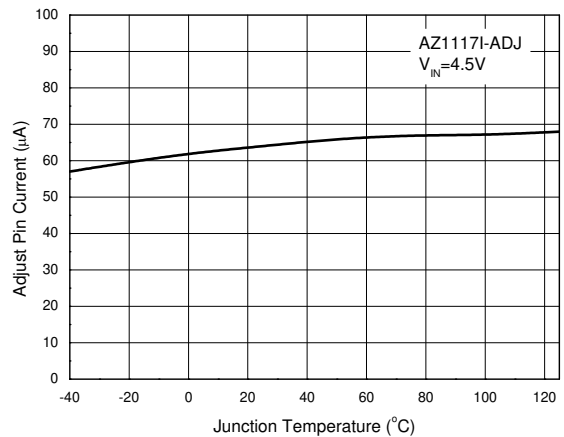

Performance Characteristics (Cont.)

Dropout Voltage vs. Output Current

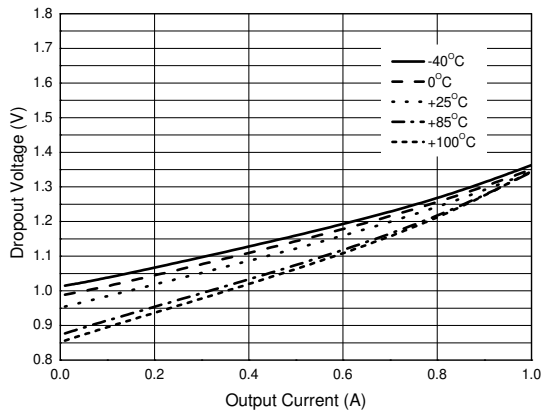

Power Dissipation vs. Temperature

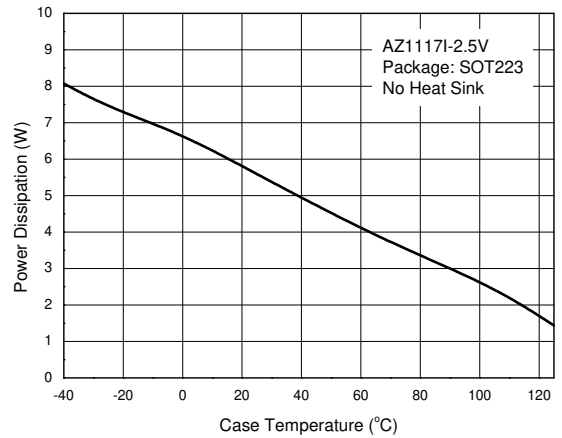

Line Transient Response

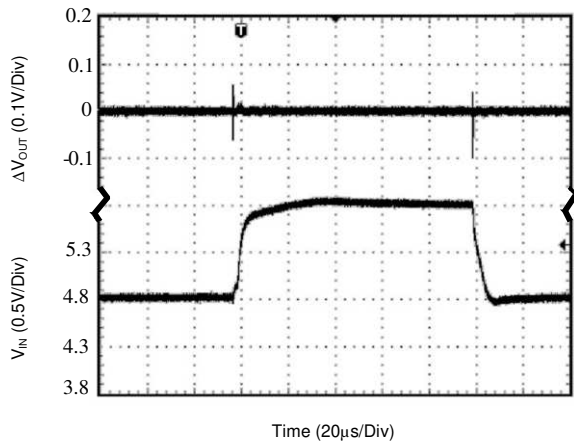

Load Transient Response

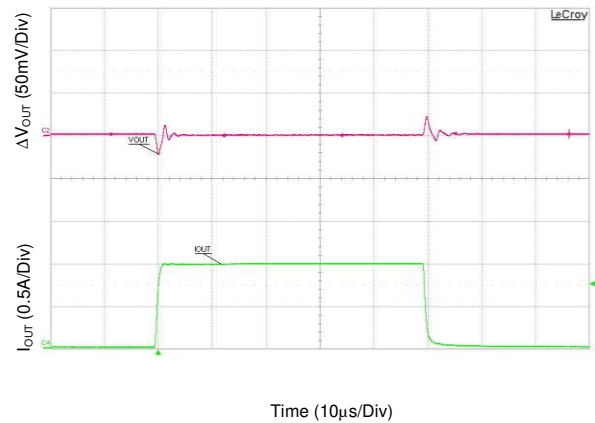

PSRR vs. Frequency

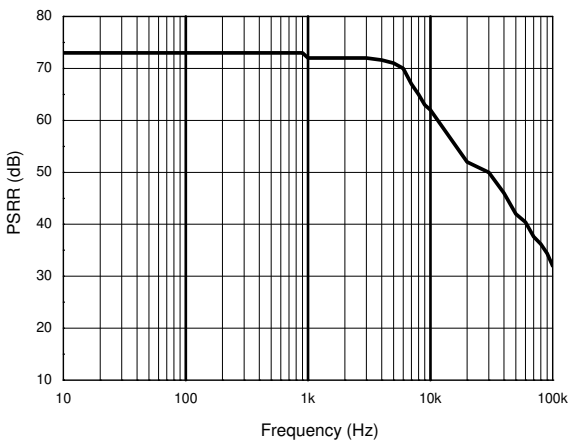

Current Limit vs. Temperature

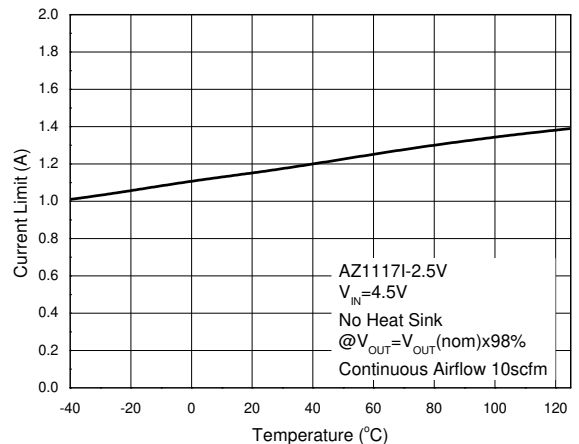

NEW PRODUCT

Performance Characteristics (Cont.)

Dropout Voltage vs. Temperature

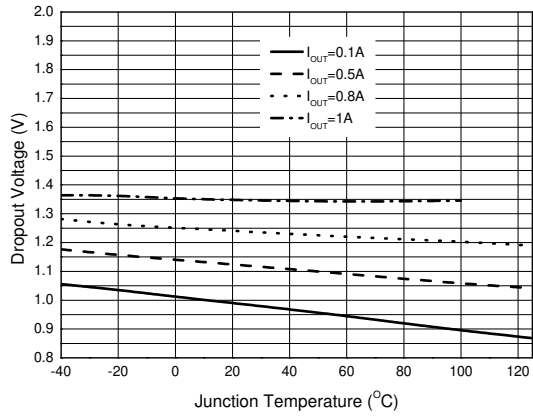

NEW PRODUCT

Ordering Information

AZ1117I X - XX XX XX

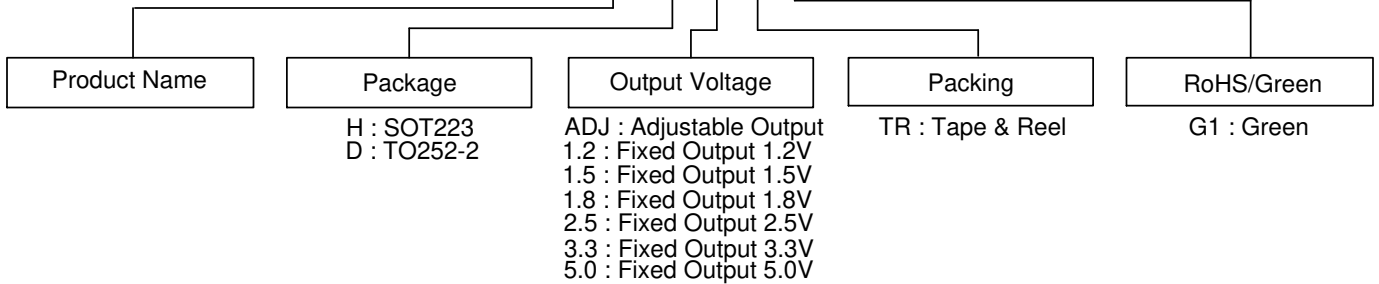

Package	Temperature Range	Part Number	Marking ID	Packing
SOT223	-40°C to +125°C	AZ1117IH-ADJTRG1	GH86J	4000/Tape & Reel
		AZ1117IH-1.2TRG1	GH86K	4000/Tape & Reel
		AZ1117IH-1.5TRG1	GH86L	4000/Tape & Reel
		AZ1117IH-1.8TRG1	GH86M	4000/Tape & Reel
		AZ1117IH-2.5TRG1	GH86N	4000/Tape & Reel
		AZ1117IH-3.3TRG1	GH86P	4000/Tape & Reel
		AZ1117IH-5.0TRG1	GH86Q	4000/Tape & Reel
TO252-2		AZ1117ID-ADJTRG1	AZ1117ID-ADJG1	2500/Tape & Reel
		AZ1117ID-1.2TRG1	AZ1117ID-1.2G1	2500/Tape & Reel
		AZ1117ID-1.5TRG1	AZ1117ID-1.5G1	2500/Tape & Reel
		AZ1117ID-1.8TRG1	AZ1117ID-1.8G1	2500/Tape & Reel
		AZ1117ID-2.5TRG1	AZ1117ID-2.5G1	2500/Tape & Reel
		AZ1117ID-3.3TRG1	AZ1117ID-3.3G1	2500/Tape & Reel
		AZ1117ID-5.0TRG1	AZ1117ID-5.0G1	2500/Tape & Reel

Marking Information

(1) SOT223

(Top View)

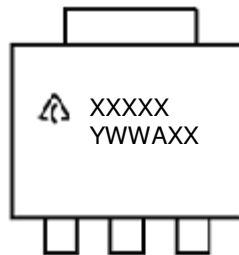

First Line: Logo and Marking ID
(See Ordering Information)
Second Line: Date Code
Y: Year
WW: Work Week of Molding
A: Assembly House Code
XX: 7th and 8th Digits of Batch Number

(2) TO252-2

(Top View)

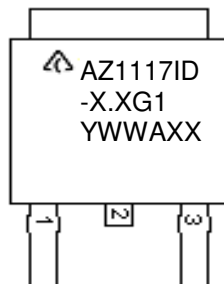

First and Second Lines: Logo and Marking ID
(See Ordering Information)
Third Line: Date Code
Y: Year
WW: Work Week of Molding
A: Assembly House Code
XX: 7th and 8th Digits of Batch Number

Package Outline Dimensions (All dimensions in mm.)

NEW PRODUCT

(1) Package Type: SOT223

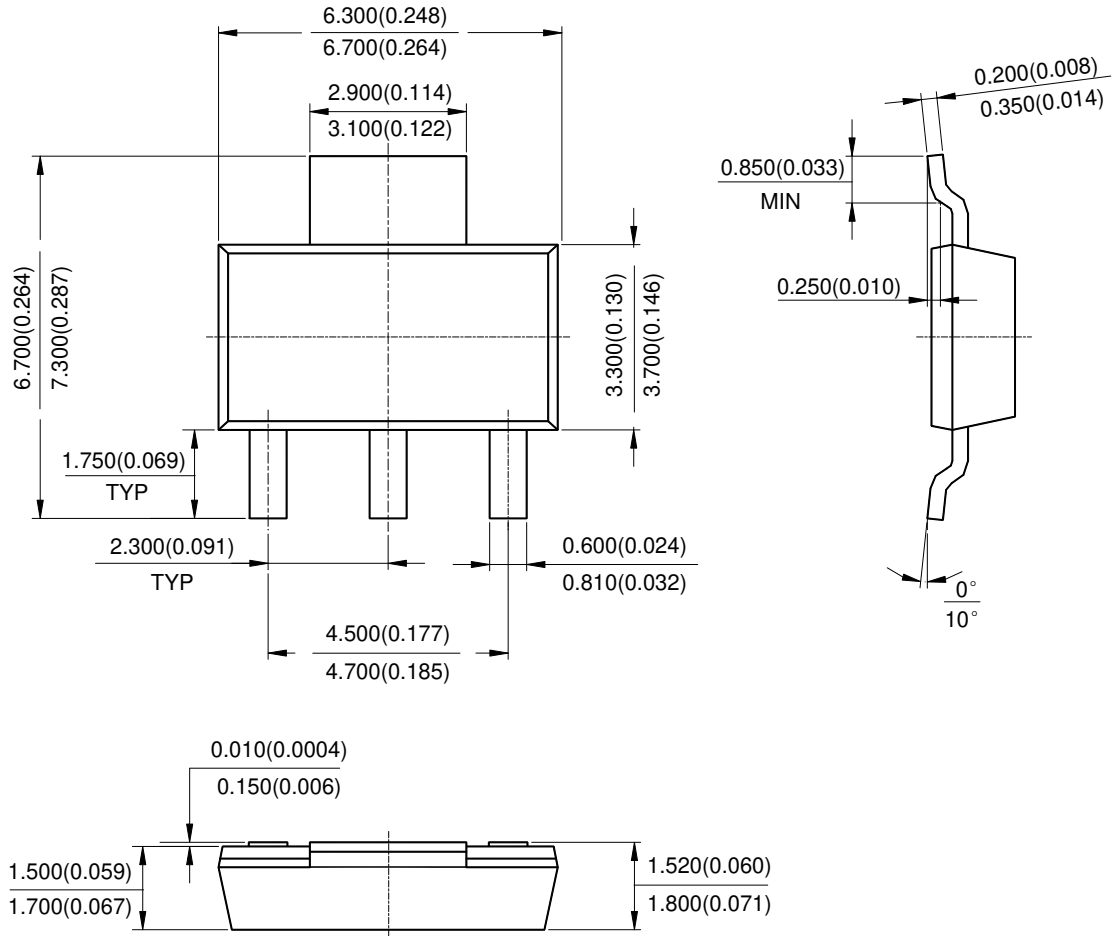

Package Outline Dimensions (All dimensions in mm.) (Cont.)

(2) Package Type: TO252-2 (5)

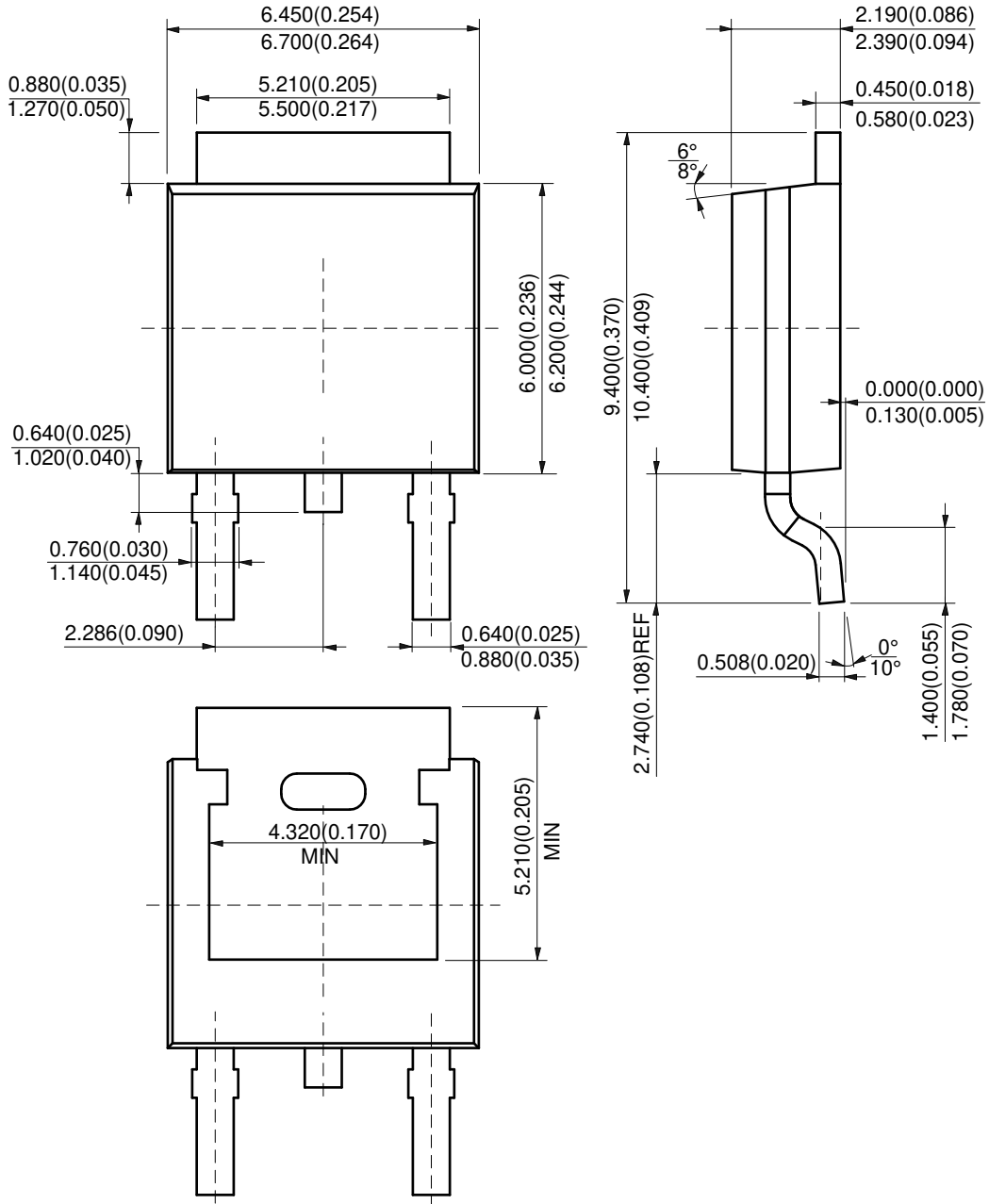

NEW PRODUCT

Suggested Pad Layout

(1) Package Type: SOT223

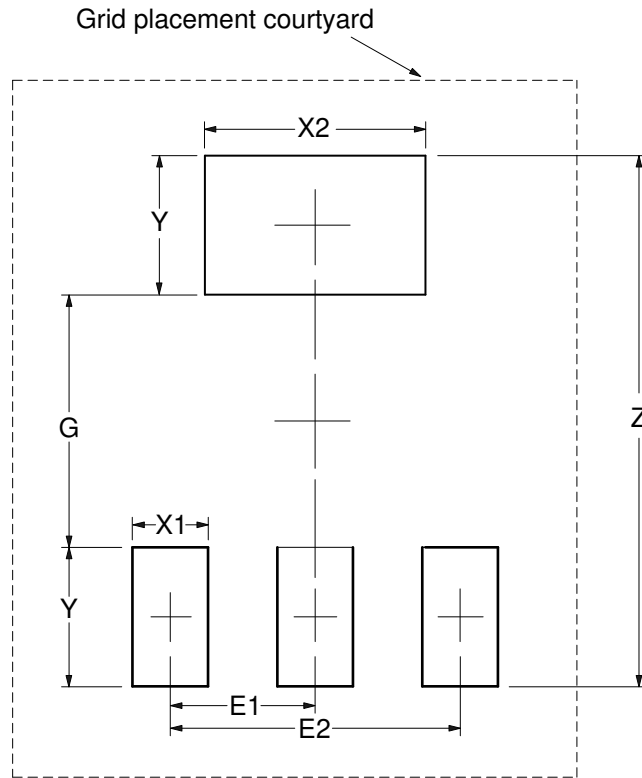

Dimensions	Z (mm)/(inch)	G (mm)/(inch)	X1 (mm)/(inch)	X2 (mm)/(inch)	Y (mm)/(inch)	E1 (mm)/(inch)	E2 (mm)/(inch)
Value	8.400/0.331	4.000/0.157	1.200/0.047	3.500/0.138	2.200/0.087	2.300/0.091	4.600/0.181

NEW PRODUCT

Suggested Pad Layout (Cont.)

(2) Package Type: TO252-2 (5)

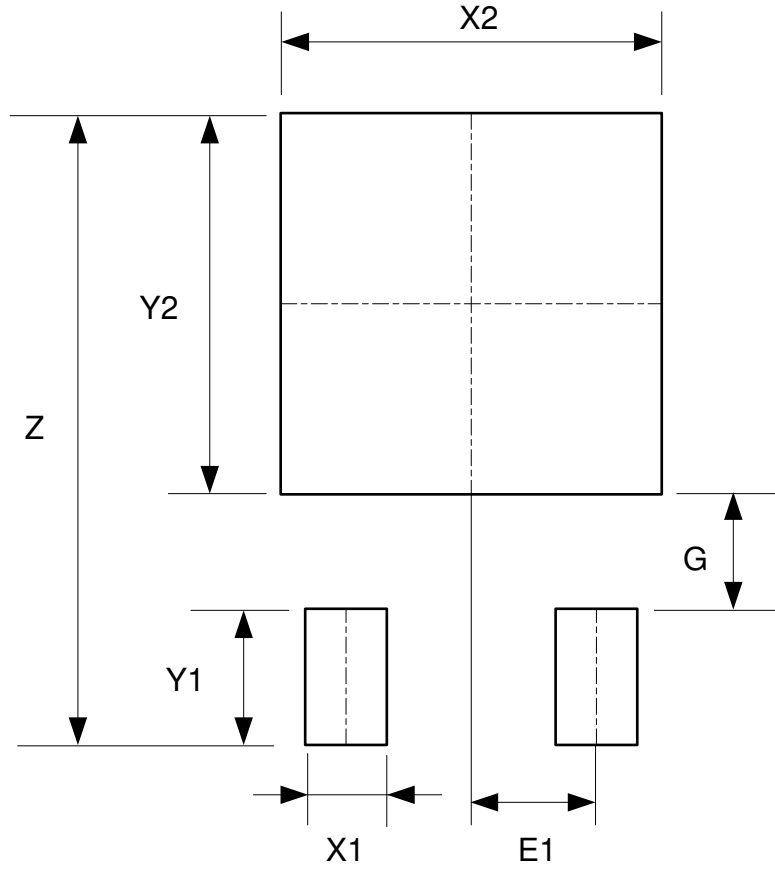

Dimensions	Z (mm)/(inch)	X1 (mm)/(inch)	X2=Y2 (mm)/(inch)	Y1 (mm)/(inch)	G (mm)/(inch)	E1 (mm)/(inch)
Value	11.600/0.457	1.500/0.059	7.000/0.276	2.500/0.098	2.100/0.083	2.300/0.091

NEW PRODUCT

IMPORTANT NOTICE

DIODES INCORPORATED MAKES NO WARRANTY OF ANY KIND, EXPRESS OR IMPLIED, WITH REGARDS TO THIS DOCUMENT, INCLUDING, BUT NOT LIMITED TO, THE IMPLIED WARRANTIES OF MERCHANTABILITY AND FITNESS FOR A PARTICULAR PURPOSE (AND THEIR EQUIVALENTS UNDER THE LAWS OF ANY JURISDICTION).

Diodes Incorporated and its subsidiaries reserve the right to make modifications, enhancements, improvements, corrections or other changes without further notice to this document and any product described herein. Diodes Incorporated does not assume any liability arising out of the application or use of this document or any product described herein; neither does Diodes Incorporated convey any license under its patent or trademark rights, nor the rights of others. Any Customer or user of this document or products described herein in such applications shall assume all risks of such use and will agree to hold Diodes Incorporated and all the companies whose products are represented on Diodes Incorporated website, harmless against all damages.

Diodes Incorporated does not warrant or accept any liability whatsoever in respect of any products purchased through unauthorized sales channel. Should Customers purchase or use Diodes Incorporated products for any unintended or unauthorized application, Customers shall indemnify and hold Diodes Incorporated and its representatives harmless against all claims, damages, expenses, and attorney fees arising out of, directly or indirectly, any claim of personal injury or death associated with such unintended or unauthorized application.

Products described herein may be covered by one or more United States, international or foreign patents pending. Product names and markings noted herein may also be covered by one or more United States, international or foreign trademarks.

This document is written in English but may be translated into multiple languages for reference. Only the English version of this document is the final and determinative format released by Diodes Incorporated.

LIFE SUPPORT

Diodes Incorporated products are specifically not authorized for use as critical components in life support devices or systems without the express written approval of the Chief Executive Officer of Diodes Incorporated. As used herein:

A. Life support devices or systems are devices or systems which:

1. are intended to implant into the body, or
2. support or sustain life and whose failure to perform when properly used in accordance with instructions for use provided in the labeling can be reasonably expected to result in significant injury to the user.

B. A critical component is any component in a life support device or system whose failure to perform can be reasonably expected to cause the failure of the life support device or to affect its safety or effectiveness.

Customers represent that they have all necessary expertise in the safety and regulatory ramifications of their life support devices or systems, and acknowledge and agree that they are solely responsible for all legal, regulatory and safety-related requirements concerning their products and any use of Diodes Incorporated products in such safety-critical, life support devices or systems, notwithstanding any devices- or systems-related information or support that may be provided by Diodes Incorporated. Further, Customers must fully indemnify Diodes Incorporated and its representatives against any damages arising out of the use of Diodes Incorporated products in such safety-critical, life support devices or systems.

Copyright © 2015, Diodes Incorporated

www.diodes.com