



Chipsmall Limited consists of a professional team with an average of over 10 year of expertise in the distribution of electronic components. Based in Hongkong, we have already established firm and mutual-benefit business relationships with customers from,Europe,America and south Asia,supplying obsolete and hard-to-find components to meet their specific needs.

With the principle of “Quality Parts,Customers Priority,Honest Operation,and Considerate Service”,our business mainly focus on the distribution of electronic components. Line cards we deal with include Microchip,ALPS,ROHM,Xilinx,Pulse,ON,Everlight and Freescale. Main products comprise IC,Modules,Potentiometer,IC Socket,Relay,Connector.Our parts cover such applications as commercial,industrial, and automotives areas.

We are looking forward to setting up business relationship with you and hope to provide you with the best service and solution. Let us make a better world for our industry!



## Contact us

Tel: +86-755-8981 8866 Fax: +86-755-8427 6832

Email & Skype: info@chipsmall.com Web: www.chipsmall.com

Address: A1208, Overseas Decoration Building, #122 Zhenhua RD., Futian, Shenzhen, China



## Description

The AZ1117 is a series of low dropout three-terminal regulators with a dropout of 1.15V at 1A output current.

The AZ1117 series provides current limiting and thermal shutdown. Its circuit includes a trimmed bandgap reference to assure output voltage accuracy to be within 1% for 1.5V, 1.8V, 2.5V, 2.85V, 3.3V, 5.0V and adjustable versions or 2% for 1.2V version. Current limit is trimmed to ensure specified output current and controlled short-circuit current. On-chip thermal shutdown provides protection against any combination of overload and ambient temperature that would create excessive junction temperature.

The AZ1117 has an adjustable version, which can provide the output voltage from 1.25V to 12V with only 2 external resistors.

The AZ1117 series is available in the industry standard SOT223, SOT89, TO220-3, TO252-2 (3), TO252-2 (4), TO252-2 (5) and TO263 power packages.

## Features

- Low Dropout Voltage: 1.15V at 1A Output Current
- Trimmed Current Limit
- On-chip Thermal Shutdown
- Three-terminal Adjustable or Fixed 1.2V, 1.5V, 1.8V, 2.5V, 2.85V, 3.3V, 5.0V
- Operation Junction Temperature: -40 to +125°C
- Lead-Free Packages: SOT223, SOT89, TO220-3, TO252-2 (3), TO252-2 (4), TO252-2 (5), TO263
- **Totally Lead-Free; RoHS Compliant (Notes 1 & 2)**

## Applications

- PC Motherboard
- LCD Monitor
- Graphic Card
- DVD-video Player
- NIC/Switch
- Telecom Equipment
- ADSL Modem
- Printer and other Peripheral Equipment

- Notes:
1. No purposely added lead. Fully EU Directive 2002/95/EC (RoHS) & 2011/65/EU (RoHS 2) compliant.
  2. See [http://www.diodes.com/quality/lead\\_free.html](http://www.diodes.com/quality/lead_free.html) for more information about Diodes Incorporated's definitions of Halogen- and Antimony-free, "Green" and Lead-free.

## Pin Assignments

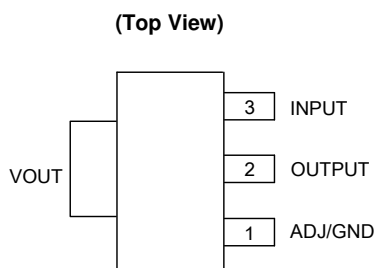

(SOT223/ H Package)

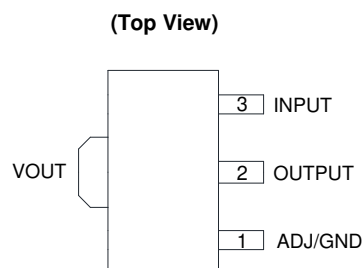

(SOT89 Option 1/ R Package)

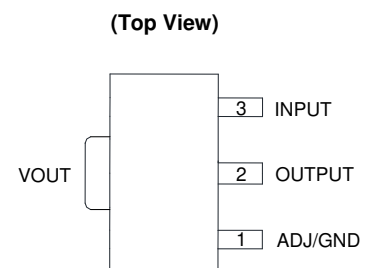

(SOT89 Option 2/ R Package)

**Pin Assignments (Cont.)**

(Top View)

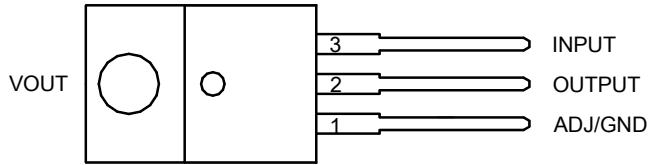

(TO220-3 Option 1/ T Package)

(Top View)

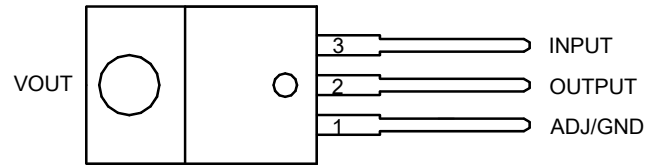

(TO220-3 Option 2/ T Package)

(Top View)

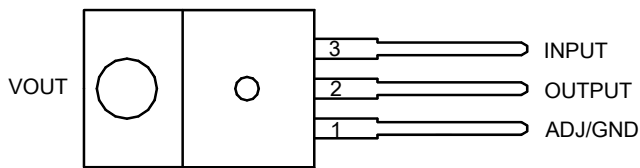

(TO220-3 Option 3/ T Package)

(Top View)

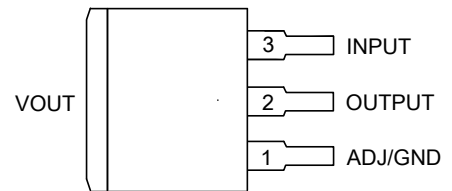

(TO263/ S Package)

(Top View)

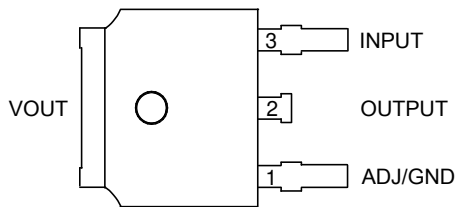

(TO252-2 (3) Option 1/ D Package)

(Top View)

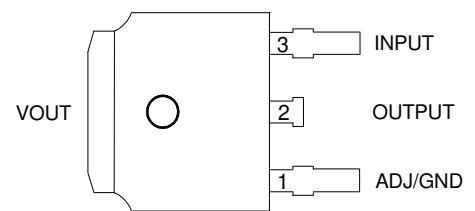

(TO252-2 (3) Option 2/ D Package)

(Top View)

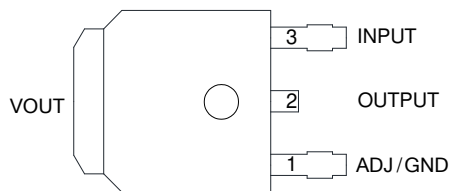

(TO252-2 (4)/ D Package)

(Top View)

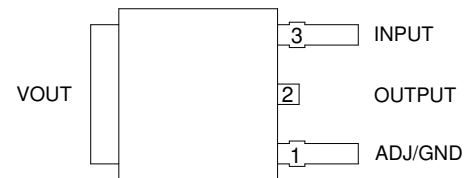

(TO252-2 (5)/ D Package)

**Typical Applications Circuit**

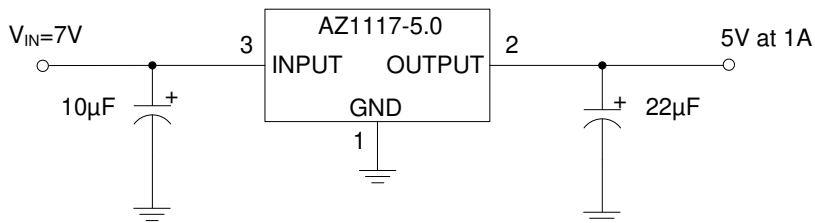
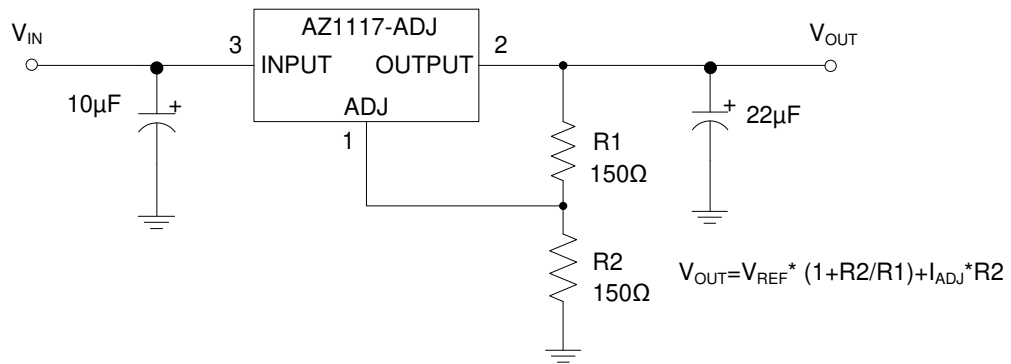

**Functional Block Diagram**

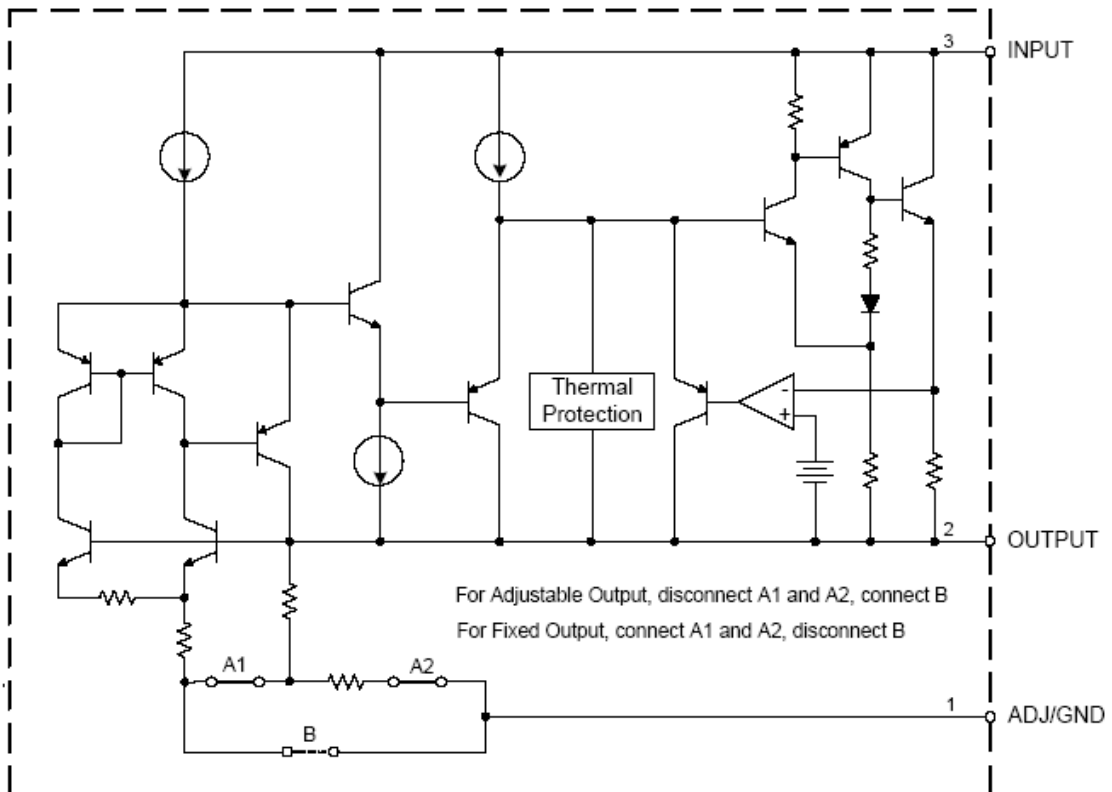

## Absolute Maximum Ratings (Note 3)

Parameter	Symbol	Value		Unit
Input Voltage	$V_{IN}$	20		V
Operating Junction Temperature	$T_J$	+150		°C
Storage Temperature	$T_S$	-65 to +150		°C
Lead Temperature (Soldering, 10sec)	$T_{LEAD}$	+260		°C
Thermal Resistance (No Heatsink, Note 4)	$\theta_{JA}$	SOT223	120	°C/W
		SOT89	165	
		TO220-3	60	
		TO252-2 (3) TO252-2 (4) TO252-2 (5)	100	
		TO263	60	
ESD (Human Body Model)	ESD	2000		V
ESD (Machine Model)	ESD	250		V

- Notes:
- Stresses greater than those listed under "Absolute Maximum Ratings" may cause permanent damage to the device. These are stress ratings only, and functional operation of the device at these or any other conditions beyond those indicated under "Recommended Operating Conditions" is not implied. Exposure to "Absolute Maximum Ratings" for extended periods may affect device reliability.
  - Absolute maximum ratings indicate limits beyond which damage to the component may occur. Electrical specifications do not apply when operating the device outside of its operating ratings. The maximum allowable power dissipation is a function of the maximum junction temperature,  $T_{J(max)}$ , the junction-to-ambient thermal resistance,  $\theta_{JA}$ , and the ambient temperature,  $T_A$ . The maximum allowable power dissipation at any ambient temperature is calculated using:  $P_{D(max)} = (T_{J(max)} - T_A) / \theta_{JA}$ . Exceeding the maximum allowable power dissipation will result in excessive die temperature, and the regulator will go into thermal shutdown.

## Recommended Operating Conditions

Parameter	Symbol	Min	Max	Unit
Input Voltage	$V_{IN}$	-	15	V
Operating Junction Temperature Range	$T_J$	-40	+125	°C

## Electrical Characteristics

### AZ1117-ADJ Electrical Characteristics (Operating Conditions: $V_{IN} \leq 10V$ , $T_J = +25^\circ C$ , unless otherwise specified.)

Parameter	Symbol	Conditions	Min	Typ	Max	Unit
Reference Voltage	$V_{REF}$	$I_{OUT} = 10mA$ , $V_{IN}-V_{OUT} = 2V$ $10mA \leq I_{OUT} \leq 1A$ , $1.4V \leq V_{IN}-V_{OUT} \leq 8V$ , $P \leq$ Maximum Power Dissipation	1.238 1.225	1.250 1.250	1.262 1.270	V
Line Regulation	$\Delta V_{OUT}$	$I_{OUT}=10mA$ , $1.5V \leq V_{IN}-V_{OUT} \leq 10V$	–	0.035	0.2	%
Load Regulation	$\Delta V_{OUT}$	$V_{IN}-V_{OUT} = 2V$ , $10mA \leq I_{OUT} \leq 1A$	–	0.2	0.4	%
Dropout Voltage	$V_{DROPO}$	$\Delta V_{REF} = 1\%$ , $I_{OUT} = 0.1A$	–	1.00	1.1	V
		$\Delta V_{REF} = 1\%$ , $I_{OUT} = 0.5A$	–	1.08	1.18	V
		$\Delta V_{REF} = 1\%$ , $I_{OUT} = 1.0A$	–	1.15	1.25	V
Current Limit	$I_{LIMIT}$	$V_{IN}-V_{OUT} = 2V$	1.25	1.35	–	A
Adjust Pin Current	$I_{ADJ}$	–	–	60	120	$\mu A$
Adjust Pin Current Change	$\Delta I_{ADJ}$	$1.4V \leq V_{IN}-V_{OUT} \leq 10V$ , $10mA \leq I_{OUT} \leq 1A$	–	0.2	5	$\mu A$
Minimum Load Current (ADJ)	$I_{LOAD(MIN)}$	$1.5V \leq V_{IN}-V_{OUT} \leq 10V$ (ADJ only)	–	1.7	5	mA
Quiescent Current	$I_Q$	$V_{IN} = V_{OUT} + 1.25V$	–	5	10	mA
Ripple Rejection	PSRR	$f = 120Hz$ , $C_{OUT} = 22\mu F$ Tantalum, $V_{IN}-V_{OUT} = 3V$ , $I_{OUT} = 1A$	60	75	–	dB
Temperature Stability	–	–	–	0.5	–	%
Long-term Stability	–	$T_A = +125^\circ C$ , 1000hrs	–	0.3	–	%
RMS Output Noise (% of $V_{OUT}$ )	–	$T_A = +25^\circ C$ , $10Hz \leq f \leq 10kHz$	–	0.003	–	%
Thermal Shutdown	–	Junction Temperature	–	+150	–	$^\circ C$
Thermal Shutdown Hysteresis	–	–	–	+25	–	$^\circ C$
Thermal Resistance	$\theta_{JC}$	SOT223	–	25	–	$^\circ C/W$
		SOT89	–	30	–	
		TO220-3	–	10	–	
		TO252-2 (3)/TO252-2 (4)/TO252-2 (5)	–	17	–	
		TO263	–	10	–	

## Electrical Characteristics (Cont.)

### AZ1117-1.2 Electrical Characteristics (Operating Conditions: $V_{IN} \leq 10V$ , $T_J = +25^\circ C$ , unless otherwise specified.)

Parameter	Symbol	Conditions	Min	Typ	Max	Unit
Output Voltage	$V_{OUT}$	$I_{OUT} = 10mA$ , $V_{IN} = 3.2V$ $10mA \leq I_{OUT} \leq 1A$ , $3.0V \leq V_{IN} \leq 10V$	1.176 1.152	1.2 1.2	1.224 1.248	V
Line Regulation	$\Delta V_{OUT}$	$I_{OUT}=10mA$ , $1.5V \leq V_{IN}-V_{OUT} \leq 10V$	–	1	6	mV
Load Regulation	$\Delta V_{OUT}$	$V_{IN}-V_{OUT} = 2V$ , $10mA \leq I_{OUT} \leq 1A$	–	1	10	mV
Dropout Voltage	$V_{DROPO}$	$\Delta V_{OUT} = 1\%$ , $I_{OUT} = 0.1A$	–	1.00	1.1	V
		$\Delta V_{OUT} = 1\%$ , $I_{OUT} = 0.5A$	–	1.08	1.18	V
		$\Delta V_{OUT} = 1\%$ , $I_{OUT} = 1.0A$	–	1.15	1.25	V
Current Limit	$I_{LIMIT}$	$V_{IN}-V_{OUT} = 2V$	1.25	1.35	–	A
Quiescent Current	$I_Q$	$V_{IN} = V_{OUT} + 1.25V$	–	5	10	mA
Ripple Rejection	PSRR	$f = 120Hz$ , $C_{OUT} = 22\mu F$ Tantalum, $V_{IN}-V_{OUT} = 3V$ , $I_{OUT} = 1A$	60	75	–	dB
Temperature Stability	–	–	–	0.5	–	%
Long-term Stability	–	$T_A = +125^\circ C$ , 1000hrs	–	0.3	–	%
RMS Output Noise (% of $V_{OUT}$ )	–	$T_A = +25^\circ C$ , $10Hz \leq f \leq 10kHz$	–	0.003	–	%
Thermal Shutdown	–	Junction Temperature	–	+150	–	$^\circ C$
Thermal Shutdown Hysteresis	–	–	–	+25	–	$^\circ C$
Thermal Resistance	$\theta_{JC}$	SOT223	–	25	–	$^\circ C/W$
		SOT89	–	30	–	
		TO220-3	–	10	–	
		TO252-2 (3)/TO252-2 (4)/TO252-2 (5)	–	17	–	
		TO263	–	10	–	

## Electrical Characteristics (Cont.)

### AZ1117-1.5 Electrical Characteristics (Operating Conditions: $V_{IN} \leq 10V$ , $T_J = +25^\circ C$ , unless otherwise specified.)

Parameter	Symbol	Conditions	Min	Typ	Max	Unit
Output Voltage	$V_{OUT}$	$I_{OUT} = 10mA$ , $V_{IN} = 3.5V$ $10mA \leq I_{OUT} \leq 1A$ , $3.0V \leq V_{IN} \leq 10V$	1.485 1.470	1.5 1.5	1.515 1.530	V
Line Regulation	$\Delta V_{OUT}$	$I_{OUT}=10mA$ , $1.5V \leq V_{IN}-V_{OUT} \leq 10V$	–	1	6	mV
Load Regulation	$\Delta V_{OUT}$	$V_{IN}-V_{OUT} = 2V$ , $10mA \leq I_{OUT} \leq 1A$	–	1	10	mV
Dropout Voltage	$V_{DROPP}$	$\Delta V_{OUT} = 1\%$ , $I_{OUT} = 0.1A$	–	1.00	1.1	V
		$\Delta V_{OUT} = 1\%$ , $I_{OUT} = 0.5A$	–	1.08	1.18	V
		$\Delta V_{OUT} = 1\%$ , $I_{OUT} = 1.0A$	–	1.15	1.25	V
Current Limit	$I_{LIMIT}$	$V_{IN}-V_{OUT} = 2V$	1.25	1.35	–	A
Quiescent Current	$I_Q$	$V_{IN} = V_{OUT} + 1.25V$	–	5	10	mA
Ripple Rejection	PSRR	$f = 120Hz$ , $C_{OUT} = 22\mu F$ Tantalum, $V_{IN}-V_{OUT} = 3V$ , $I_{OUT} = 1A$	60	75	–	dB
Temperature Stability	–	–	–	0.5	–	%
Long-term Stability	–	$T_A = +125^\circ C$ , 1000hrs	–	0.3	–	%
RMS Output Noise (% of $V_{OUT}$ )	–	$T_A = +25^\circ C$ , $10Hz \leq f \leq 10kHz$	–	0.003	–	%
Thermal Shutdown	–	Junction Temperature	–	+150	–	$^\circ C$
Thermal Shutdown Hysteresis	–	–	–	+25	–	$^\circ C$
Thermal Resistance	$\theta_{JC}$	SOT223	–	25	–	$^\circ C/W$
		SOT89	–	30	–	
		TO220-3	–	10	–	
		TO252-2 (3)/TO252-2 (4)/TO252-2 (5)	–	17	–	
		TO263	–	10	–	



## Electrical Characteristics (Cont.)

### AZ1117-1.8 Electrical Characteristics (Operating Conditions: $V_{IN} \leq 10V$ , $T_J = +25^\circ C$ , unless otherwise specified.)

Parameter	Symbol	Conditions	Min	Typ	Max	Unit
Output Voltage	$V_{OUT}$	$I_{OUT} = 10mA$ , $V_{IN} = 3.8V$ $10mA \leq I_{OUT} \leq 1A$ , $3.2V \leq V_{IN} \leq 10V$	1.782 1.746	1.8 1.8	1.818 1.854	V
Line Regulation	$\Delta V_{OUT}$	$I_{OUT}=10mA$ , $1.5V \leq V_{IN}-V_{OUT} \leq 10V$	–	1	6	mV
Load Regulation	$\Delta V_{OUT}$	$V_{IN}-V_{OUT} = 2V$ , $10mA \leq I_{OUT} \leq 1A$	–	1	10	mV
Dropout Voltage	$V_{DROPP}$	$\Delta V_{OUT} = 1\%$ , $I_{OUT} = 0.1A$	–	1.00	1.1	V
		$\Delta V_{OUT} = 1\%$ , $I_{OUT} = 0.5A$	–	1.08	1.18	V
		$\Delta V_{OUT} = 1\%$ , $I_{OUT} = 1.0A$	–	1.15	1.25	V
Current Limit	$I_{LIMIT}$	$V_{IN}-V_{OUT} = 2V$	1.25	1.35	–	A
Quiescent Current	$I_Q$	$V_{IN} = V_{OUT} + 1.25V$	–	5	10	mA
Ripple Rejection	PSRR	$f = 120Hz$ , $C_{OUT} = 22\mu F$ Tantalum, $V_{IN}-V_{OUT} = 3V$ , $I_{OUT} = 1A$	60	75	–	dB
Temperature Stability	–	–	–	0.5	–	%
Long-term Stability	–	$T_A = +125^\circ C$ , 1000hrs	–	0.3	–	%
RMS Output Noise (% of $V_{OUT}$ )	–	$T_A = +25^\circ C$ , $10Hz \leq f \leq 10kHz$	–	0.003	–	%
Thermal Shutdown	–	Junction Temperature	–	+150	–	$^\circ C$
Thermal Shutdown Hysteresis	–	–	–	+25	–	$^\circ C$
Thermal Resistance	$\theta_{JC}$	SOT223	–	25	–	$^\circ C/W$
		SOT89	–	30	–	
		TO220-3	–	10	–	
		TO252-2 (3)/TO252-2 (4)/TO252-2 (5)	–	17	–	
		TO263	–	10	–	

## Electrical Characteristics (Cont.)

### AZ1117-2.5 Electrical Characteristics (Operating Conditions: $V_{IN} \leq 10V$ , $T_J = +25^\circ C$ , unless otherwise specified.)

Parameter	Symbol	Conditions	Min	Typ	Max	Unit
Output Voltage	$V_{OUT}$	$I_{OUT} = 10mA$ , $V_{IN} = 4.5V$ $10mA \leq I_{OUT} \leq 1A$ , $3.9V \leq V_{IN} \leq 10V$	2.475 2.450	2.5 2.5	2.525 2.550	V
Line Regulation	$\Delta V_{OUT}$	$I_{OUT}=10mA$ , $1.5V \leq V_{IN}-V_{OUT} \leq 10V$	–	1	6	mV
Load Regulation	$\Delta V_{OUT}$	$V_{IN}-V_{OUT} = 2V$ , $10mA \leq I_{OUT} \leq 1A$	–	1	10	mV
Dropout Voltage	$V_{DROD}$	$\Delta V_{OUT} = 1\%$ , $I_{OUT} = 0.1A$	–	1.00	1.1	V
		$\Delta V_{OUT} = 1\%$ , $I_{OUT} = 0.5A$	–	1.08	1.18	V
		$\Delta V_{OUT} = 1\%$ , $I_{OUT} = 1.0A$	–	1.15	1.25	V
Current Limit	$I_{LIMIT}$	$V_{IN}-V_{OUT} = 2V$	1.25	1.35	–	A
Quiescent Current	$I_Q$	$V_{IN} = V_{OUT} + 1.25V$	–	5	10	mA
Ripple Rejection	PSRR	$f = 120Hz$ , $C_{OUT} = 22\mu F$ Tantalum, $V_{IN}-V_{OUT} = 3V$ , $I_{OUT} = 1A$	60	75	–	dB
Temperature Stability	–	–	–	0.5	–	%
Long-term Stability	–	$T_A = +125^\circ C$ , 1000hrs	–	0.3	–	%
RMS Output Noise (% of $V_{OUT}$ )	–	$T_A = +25^\circ C$ , $10Hz \leq f \leq 10kHz$	–	0.003	–	%
Thermal Shutdown	–	Junction Temperature	–	+150	–	$^\circ C$
Thermal Shutdown Hysteresis	–	–	–	+25	–	$^\circ C$
Thermal Resistance	$\theta_{JC}$	SOT223	–	25	–	$^\circ C/W$
		SOT89	–	30	–	
		TO220-3	–	10	–	
		TO252-2 (3)/TO252-2 (4)/TO252-2 (5)	–	17	–	
		TO263	–	10	–	

## Electrical Characteristics (Cont.)

### AZ1117-2.85 Electrical Characteristics (Operating Conditions: $V_{IN} \leq 10V$ , $T_J = +25^\circ C$ , unless otherwise specified.)

Parameter	Symbol	Conditions	Min	Typ	Max	Unit
Output Voltage	$V_{OUT}$	$I_{OUT} = 10mA$ , $V_{IN} = 4.85V$ $10mA \leq I_{OUT} \leq 1A$ , $4.25V \leq V_{IN} \leq 10V$	2.822 2.793	2.85 2.85	2.878 2.907	V
Line Regulation	$\Delta V_{OUT}$	$I_{OUT} = 10mA$ , $1.5V \leq V_{IN} - V_{OUT} \leq 10V$	–	1	6	mV
Load Regulation	$\Delta V_{OUT}$	$V_{IN} - V_{OUT} = 2V$ , $10mA \leq I_{OUT} \leq 1A$	–	1	10	mV
Dropout Voltage	$V_{DROP}$	$\Delta V_{REF} = 1\%$ , $I_{OUT} = 0.1A$	–	1.00	1.1	V
		$\Delta V_{REF} = 1\%$ , $I_{OUT} = 0.5A$	–	1.08	1.18	V
		$\Delta V_{REF} = 1\%$ , $I_{OUT} = 1.0A$	–	1.15	1.25	V
Current Limit	$I_{LIMIT}$	$V_{IN} - V_{OUT} = 2V$	1.25	1.35	–	A
Quiescent Current	$I_Q$	$V_{IN} = V_{OUT} + 1.25V$	–	5	10	mA
Ripple Rejection	PSRR	$f = 120Hz$ , $C_{OUT} = 22\mu F$ Tantalum, $V_{IN} - V_{OUT} = 3V$ , $I_{OUT} = 1A$	60	75	–	dB
Temperature Stability	–	–	–	0.5	–	%
Long-term Stability	–	$T_A = +125^\circ C$ , 1000hrs	–	0.3	–	%
RMS Output Noise (% of $V_{OUT}$ )	–	$T_A = +25^\circ C$ , $10Hz \leq f \leq 10kHz$	–	0.003	–	%
Thermal Shutdown	–	Junction Temperature	–	+150	–	$^\circ C$
Thermal Shutdown Hysteresis	–	–	–	+25	–	$^\circ C$
Thermal Resistance	$\theta_{JC}$	SOT223	–	25	–	$^\circ C/W$
		SOT89	–	30	–	
		TO220-3	–	10	–	
		TO252-2 (3)/TO252-2 (4)/TO252-2 (5)	–	17	–	
		TO263	–	10	–	

## Electrical Characteristics (Cont.)

### AZ1117-3.3 Electrical Characteristics (Operating Conditions: $V_{IN} \leq 10V$ , $T_J = +25^\circ C$ , unless otherwise specified.)

Parameter	Symbol	Conditions	Min	Typ	Max	Unit
Output Voltage	$V_{OUT}$	$I_{OUT} = 10mA$ , $V_{IN} = 5.0V$ $10mA \leq I_{OUT} \leq 1A$ , $4.75V \leq V_{IN} \leq 10V$	3.267 3.235	3.3 3.3	3.333 3.365	V
Line Regulation	$\Delta V_{OUT}$	$I_{OUT} = 10mA$ , $1.5V \leq V_{IN} - V_{OUT} \leq 10V$	–	1	6	mV
Load Regulation	$\Delta V_{OUT}$	$V_{IN} - V_{OUT} = 2V$ , $10mA \leq I_{OUT} \leq 1A$	–	1	10	mV
Dropout Voltage	$V_{DROP}$	$\Delta V_{OUT} = 1\%$ , $I_{OUT} = 0.1A$	–	1.00	1.1	V
		$\Delta V_{OUT} = 1\%$ , $I_{OUT} = 0.5A$	–	1.08	1.18	V
		$\Delta V_{OUT} = 1\%$ , $I_{OUT} = 1.0A$	–	1.15	1.25	V
Current Limit	$I_{LIMIT}$	$V_{IN} - V_{OUT} = 2V$	1.25	1.35	–	A
Quiescent Current	$I_Q$	$V_{IN} = V_{OUT} + 1.25V$	–	5	10	mA
Ripple Rejection	PSRR	$f = 120Hz$ , $C_{OUT} = 22\mu F$ Tantalum, $V_{IN} - V_{OUT} = 3V$ , $I_{OUT} = 1A$	60	75	–	dB
Temperature Stability	–	–	–	0.5	–	%
Long-term Stability	–	$T_A = +125^\circ C$ , 1000hrs	–	0.3	–	%
RMS Output Noise (% of $V_{OUT}$ )	–	$T_A = +25^\circ C$ , $10Hz \leq f \leq 10kHz$	–	0.003	–	%
Thermal Shutdown	–	Junction Temperature	–	+150	–	$^\circ C$
Thermal Shutdown Hysteresis	–	–	–	+25	–	$^\circ C$
Thermal Resistance	$\theta_{JC}$	SOT223	–	25	–	$^\circ C/W$
		SOT89	–	30	–	
		TO220-3	–	10	–	
		TO252-2 (3)/TO252-2 (4)/TO252-2 (5)	–	17	–	
		TO263	–	10	–	

## Electrical Characteristics (Cont.)

### AZ1117-5.0 Electrical Characteristics (Operating Conditions: $V_{IN} \leq 10V$ , $T_J = +25^\circ C$ , unless otherwise specified.)

Parameter	Symbol	Conditions	Min	Typ	Max	Unit
Output Voltage	$V_{OUT}$	$I_{OUT} = 10mA$ , $V_{IN} = 7.0V$ $10mA \leq I_{OUT} \leq 1A$ , $6.5V \leq V_{IN} \leq 12V$	4.950 4.900	5.0 5.0	5.050 5.100	V
Line Regulation	$\Delta V_{OUT}$	$I_{OUT} = 10mA$ , $1.5V \leq V_{IN} - V_{OUT} \leq 10V$	–	1	10	mV
Load Regulation	$\Delta V_{OUT}$	$V_{IN} - V_{OUT} = 2V$ , $10mA \leq I_{OUT} \leq 1A$	–	1	15	mV
Dropout Voltage	$V_{DROP}$	$\Delta V_{OUT} = 1\%$ , $I_{OUT} = 0.1A$	–	1.00	1.1	V
		$\Delta V_{OUT} = 1\%$ , $I_{OUT} = 0.5A$	–	1.08	1.18	V
		$\Delta V_{OUT} = 1\%$ , $I_{OUT} = 1.0A$	–	1.15	1.25	V
Current Limit	$I_{LIMIT}$	$V_{IN} - V_{OUT} = 2V$	1.25	1.35	–	A
Quiescent Current	$I_Q$	$V_{IN} = V_{OUT} + 1.25V$	–	5	10	mA
Ripple Rejection	PSRR	$f = 120Hz$ , $C_{OUT} = 22\mu F$ Tantalum, $V_{IN} - V_{OUT} = 3V$ , $I_{OUT} = 1A$	60	75	–	dB
Temperature Stability	–	–	–	0.5	–	%
Long-term Stability	–	$T_A = +125^\circ C$ , 1000hrs	–	0.3	–	%
RMS Output Noise (% of $V_{OUT}$ )	–	$T_A = +25^\circ C$ , $10Hz \leq f \leq 10kHz$	–	0.003	–	%
Thermal Shutdown	–	Junction Temperature	–	+150	–	$^\circ C$
Thermal Shutdown Hysteresis	–	–	–	+25	–	$^\circ C$
Thermal Resistance	$\theta_{JC}$	SOT223	–	25	–	$^\circ C/W$
		SOT89	–	30	–	
		TO220-3	–	10	–	
		TO252-2 (3)/TO252-2 (4)/TO252-2 (5)	–	17	–	
		TO263	–	10	–	

**Performance Characteristics**

**Dropout Voltage vs. Output Current**

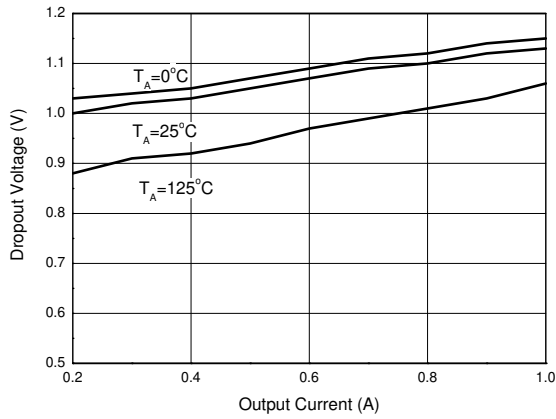

**Dropout Voltage vs. Junction Temperature**

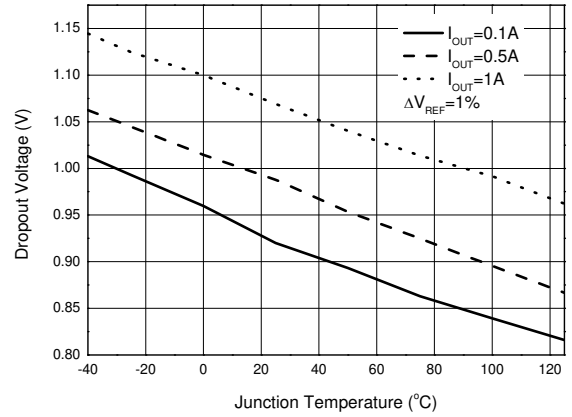

**Load Regulation vs. Junction Temperature**

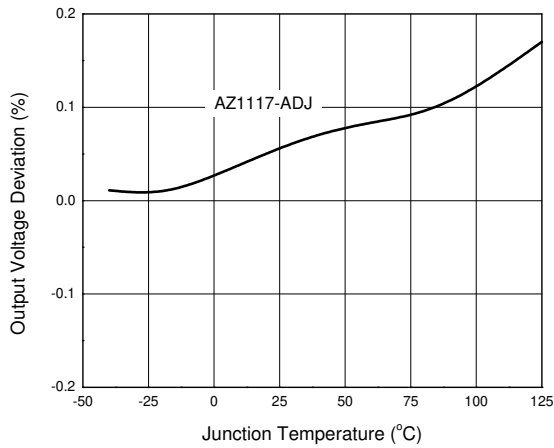

**Reference Voltage vs. Junction Temperature**

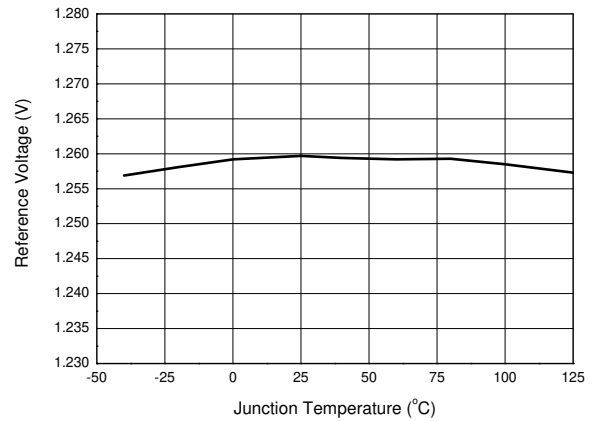

**Output Voltage vs. Junction Temperature**

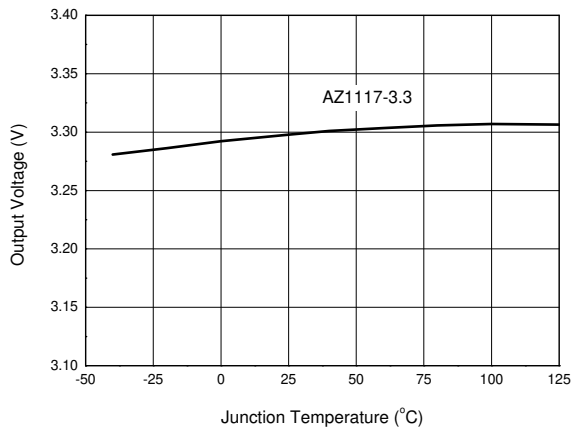

**Minimum Load Current vs. Junction Temperature**

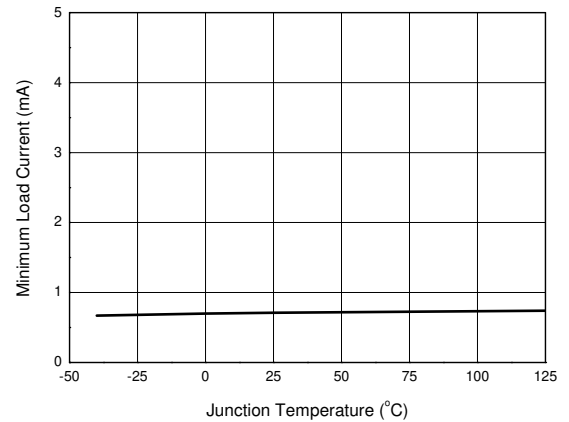

**Performance Characteristics (Cont.)**

**Adjust Pin Current vs. Junction Temperature**

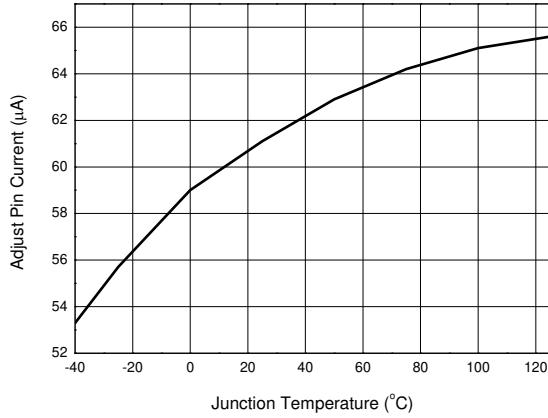

**Short-circuit Current vs. Junction Temperature**

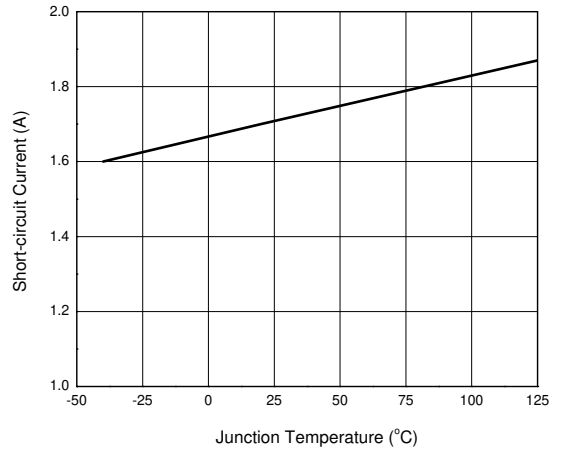

**Maximum Power Dissipation**

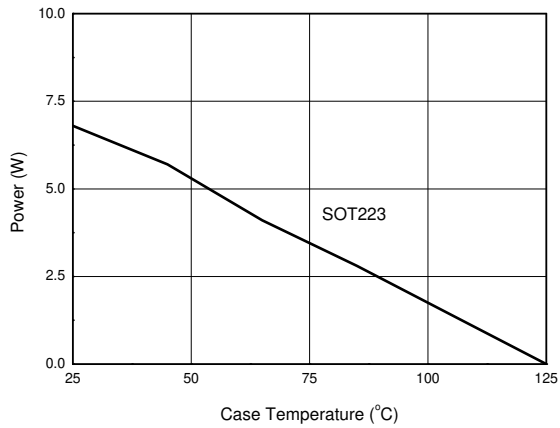

**Ripple Rejection vs. Frequency**

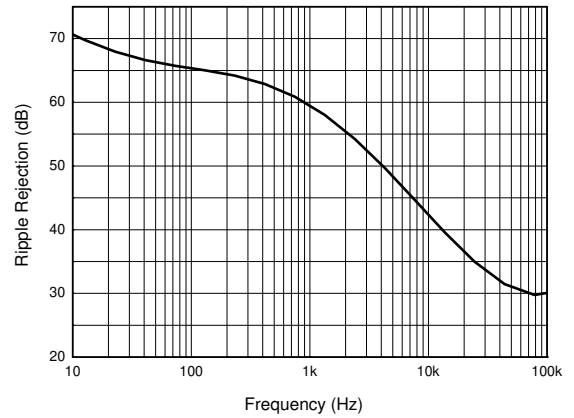

**Line Transient Response**  
(Conditions:  $V_{IN} = 4.8$  to  $5.8V$ ,  $V_{OUT} = 3.33V$ ,  
 $I_{OUT} = 0.1A$ ,  $C_{IN} = 1\mu F$ ,  $C_{OUT} = 10\mu F$ )

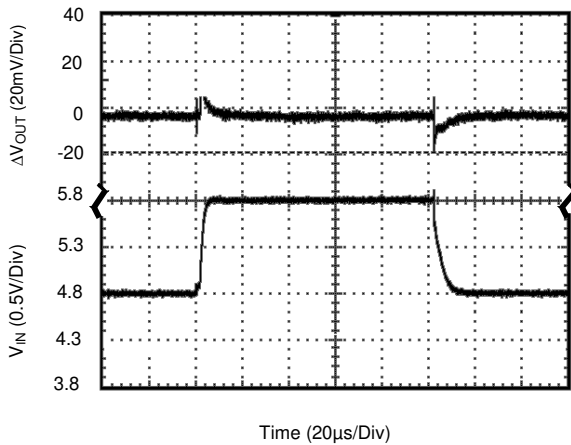

**Load Transient Response**  
(Conditions:  $V_{IN} = 4.8V$ ,  $V_{OUT} = 3.33V$ ,  
 $I_{OUT} = 0.1$  to  $0.5A$ ,  $C_{IN} = C_{OUT} = 10\mu F$ )

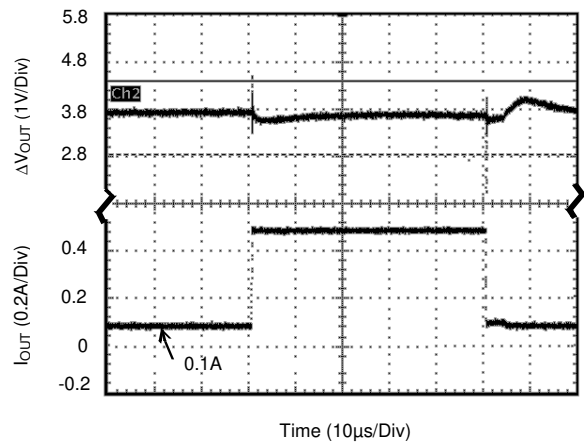

## Ordering Information

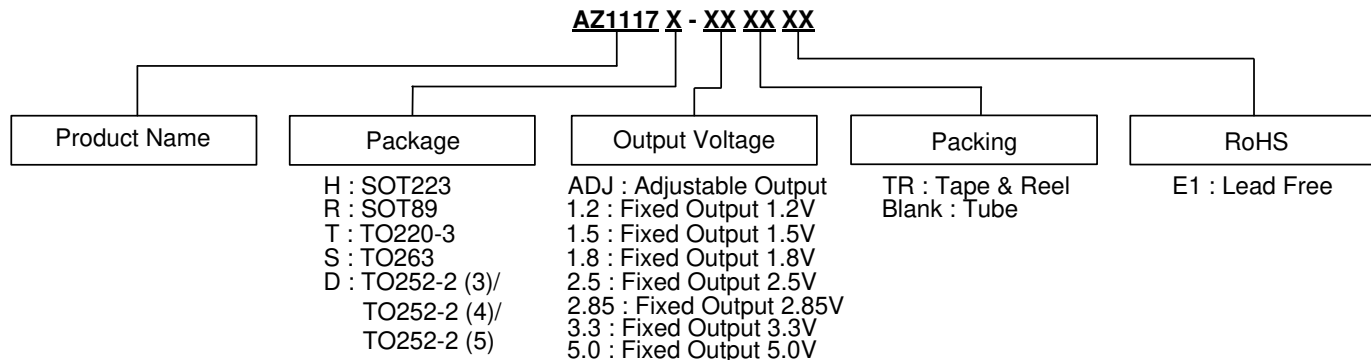

Package	Temperature Range	Part Number	Marking ID	Packing
SOT223 (Note 5)	-40 to +125°C	AZ1117H-ADJTRE1	EH11A	4000/Tape & Reel
	-40 to +125°C	AZ1117H-1.2TRE1	EH18A	4000/Tape & Reel
	-40 to +125°C	AZ1117H-1.5TRE1	EH12A	4000/Tape & Reel
	-40 to +125°C	AZ1117H-1.8TRE1	EH13A	4000/Tape & Reel
	-40 to +125°C	AZ1117H-2.5TRE1	EH14A	4000/Tape & Reel
	-40 to +125°C	AZ1117H-2.85TRE1	EH15A	4000/Tape & Reel
	-40 to +125°C	AZ1117H-3.3TRE1	EH16A	4000/Tape & Reel
	-40 to +125°C	AZ1117H-5.0TRE1	EH17A	4000/Tape & Reel
SOT89 (Note 6)	-40 to +125°C	AZ1117R-ADJTRE1	E17A	1000/Tape & Reel
	-40 to +125°C	AZ1117R-1.2TRE1	E17G	1000/Tape & Reel
	-40 to +125°C	AZ1117R-1.5TRE1	E17B	1000/Tape & Reel
	-40 to +125°C	AZ1117R-1.8TRE1	E17C	1000/Tape & Reel
	-40 to +125°C	AZ1117R-2.5TRE1	E17D	1000/Tape & Reel
	-40 to +125°C	AZ1117R-2.85TRE1	E17H	1000/Tape & Reel
	-40 to +125°C	AZ1117R-3.3TRE1	E17E	1000/Tape & Reel
	-40 to +125°C	AZ1117R-5.0TRE1	E17F	1000/Tape & Reel
TO220-3	-40 to +125°C	AZ1117T-ADJE1	AZ1117T-ADJE1	50/Tube
	-40 to +125°C	AZ1117T-1.2E1	AZ1117T-1.2E1	50/Tube
	-40 to +125°C	AZ1117T-1.5E1	AZ1117T-1.5E1	50/Tube
	-40 to +125°C	AZ1117T-1.8E1	AZ1117T-1.8E1	50/Tube
	-40 to +125°C	AZ1117T-2.5E1	AZ1117T-2.5E1	50/Tube
	-40 to +125°C	AZ1117T-2.85E1	AZ1117T-2.85E1	50/Tube
	-40 to +125°C	AZ1117T-3.3E1	AZ1117T-3.3E1	50/Tube
	-40 to +125°C	AZ1117T-5.0E1	AZ1117T-5.0E1	50/Tube



## Ordering Information (Cont.)

Package	Temperature Range	Part Number	Marking ID	Packing
TO252-2 (3)/(4)/(5) (Note 5)	-40 to +125°C	AZ1117D-ADJTRE1	AZ1117D-ADJE1	2500/Tape & Reel
	-40 to +125°C	AZ1117D-1.2TRE1	AZ1117D-1.2E1	2500/Tape & Reel
	-40 to +125°C	AZ1117D-1.5TRE1	AZ1117D-1.5E1	2500/Tape & Reel
	-40 to +125°C	AZ1117D-1.8TRE1	AZ1117D-1.8E1	2500/Tape & Reel
	-40 to +125°C	AZ1117D-2.5TRE1	AZ1117D-2.5E1	2500/Tape & Reel
	-40 to +125°C	AZ1117D-2.85TRE1	AZ1117D-2.85E1	2500/Tape & Reel
	-40 to +125°C	AZ1117D-3.3TRE1	AZ1117D-3.3E1	2500/Tape & Reel
	-40 to +125°C	AZ1117D-5.0TRE1	AZ1117D-5.0E1	2500/Tape & Reel
TO263	-40 to +125°C	AZ1117S-ADJTRE1	AZ1117S-ADJE1	800/Tape & Reel
	-40 to +125°C	AZ1117S-1.2TRE1	AZ1117S-1.2E1	800/Tape & Reel
	-40 to +125°C	AZ1117S-1.5TRE1	AZ1117S-1.5E1	800/Tape & Reel
	-40 to +125°C	AZ1117S-1.8TRE1	AZ1117S-1.8E1	800/Tape & Reel
	-40 to +125°C	AZ1117S-2.5TRE1	AZ1117S-2.5E1	800/Tape & Reel
	-40 to +125°C	AZ1117S-2.85TRE1	AZ1117S-2.85E1	800/Tape & Reel
	-40 to +125°C	AZ1117S-3.3TRE1	AZ1117S-3.3E1	800/Tape & Reel
	-40 to +125°C	AZ1117S-5.0TRE1	AZ1117S-5.0E1	800/Tape & Reel

Notes: 5. Not recommended for new design, please use AZ1117L.  
6. Not recommended for new design, please use AZ1117C.

## Marking Information

(1) SOT223 Series

(Top View)

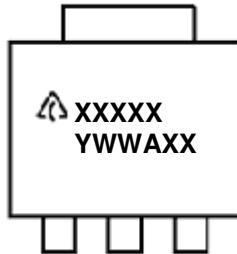

First Line: Logo and Marking ID (See Ordering Information)  
 Second Line: Date Code  
 Y: Year  
 WW: Work Week of Molding  
 A: Assembly House Code  
 XX: 7th and 8th Digits of Batch Number

(2) TO252-2 Series

(Top View)

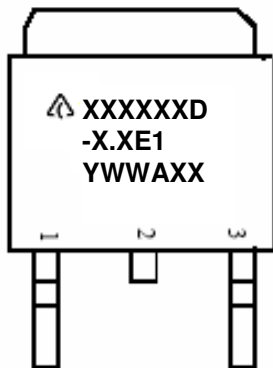

First and Second Lines: Logo and Marking ID (See Ordering Information)  
 Third Line: Date Code  
 Y: Year  
 WW: Work Week of Molding  
 A: Assembly House Code  
 XX: 7th and 8th Digits of Batch Number

(3) SOT89

(Top View)

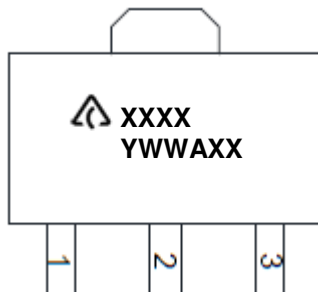

First Line: Logo and Marking ID (See Ordering Information)  
 Second Line: Date Code  
 Y: Year  
 WW: Work Week of Molding  
 A: Assembly House Code  
 XX: 7th and 8th Digits of Batch Number

**Marking Information** (Cont.)

(4) TO220-3

(Top View)

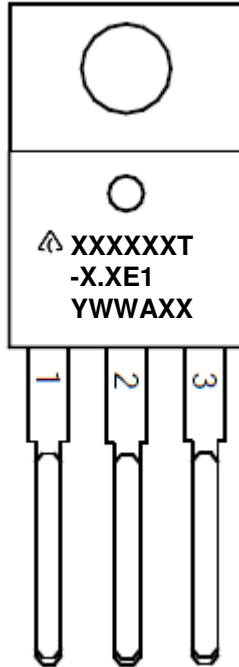

First and Second Lines: Logo and Marking ID  
(See Ordering Information)  
Third Line: Date Code  
Y: Year  
WW: Work Week of Molding  
A: Assembly House Code  
XX: 7th and 8th Digits of Batch Number

(5) TO263

(Top View)

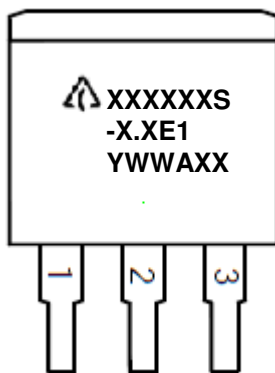

First and Second Lines: Logo and Marking ID  
(See Ordering Information)  
Third Line: Date Code  
Y: Year  
WW: Work Week of Molding  
A: Assembly House Code  
XX: 7th and 8th Digits of Batch Number

**Package Outline Dimensions** (All dimensions in mm (inch).)

(1) Package Type: SOT223

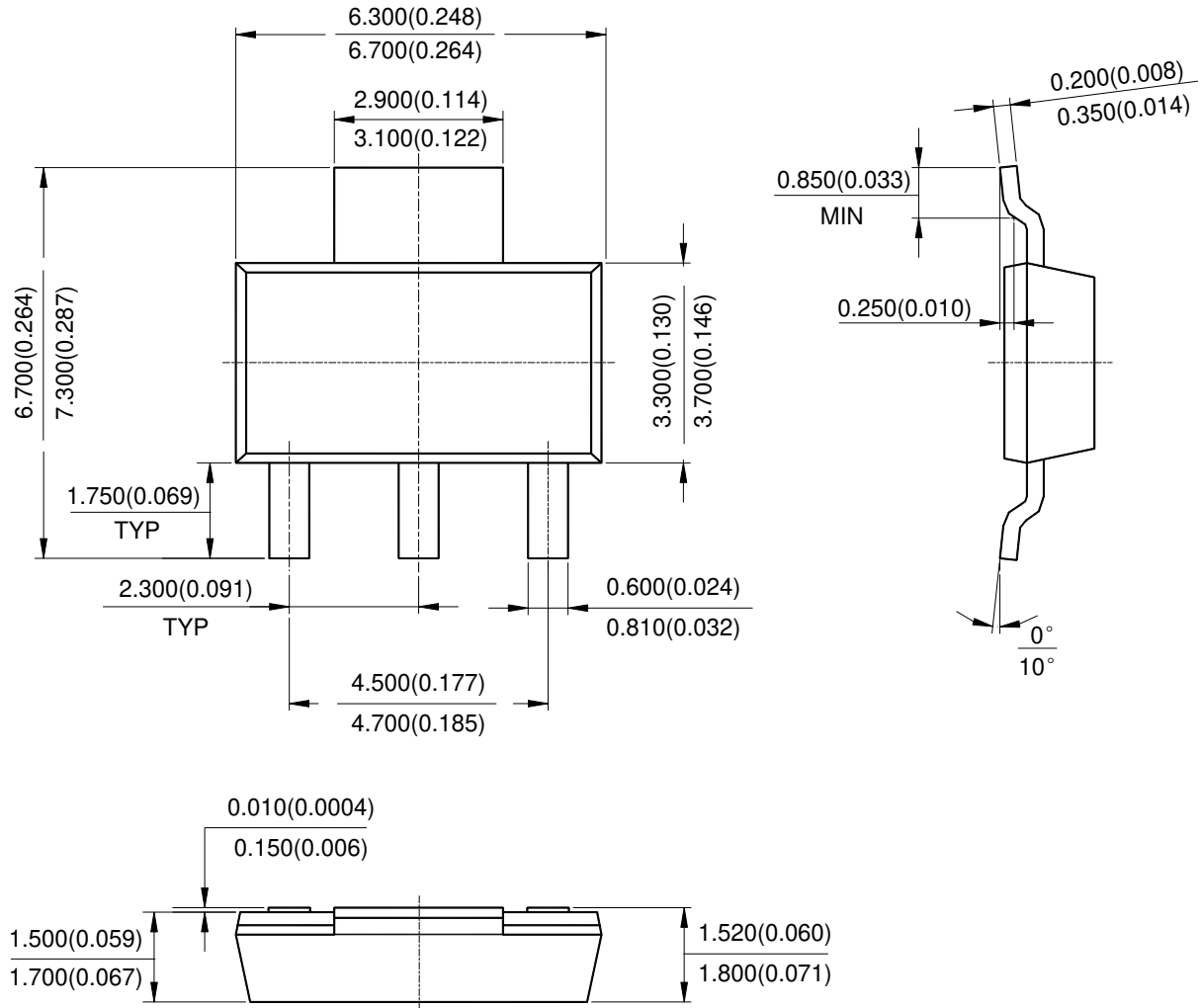

**Package Outline Dimensions** (Cont. All dimensions in mm(inch).)

(2) Package Type: SOT89

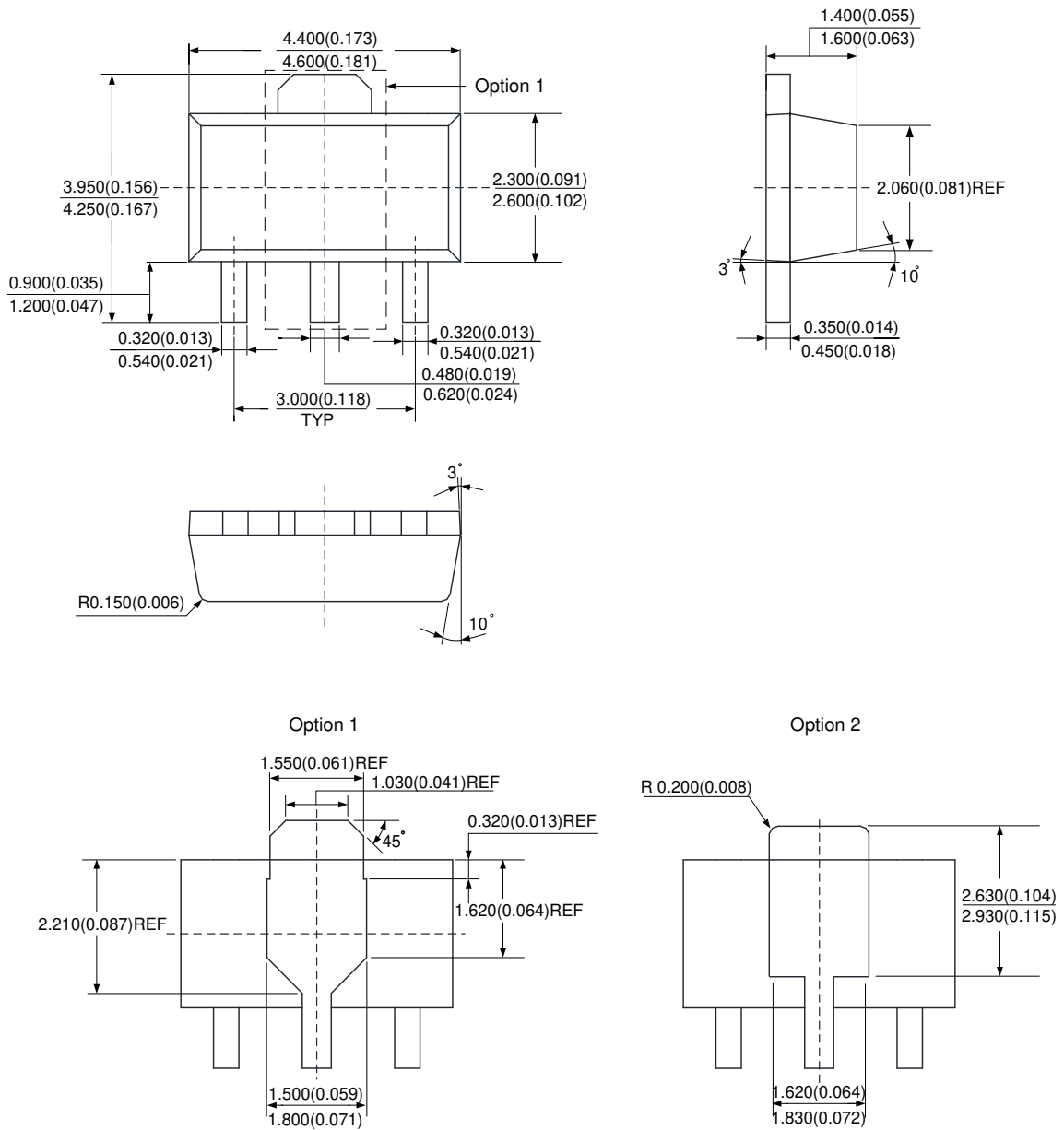

**Package Outline Dimensions** (Cont. All dimensions in mm(inch).)

(3) Package Type: TO252-2 (3)

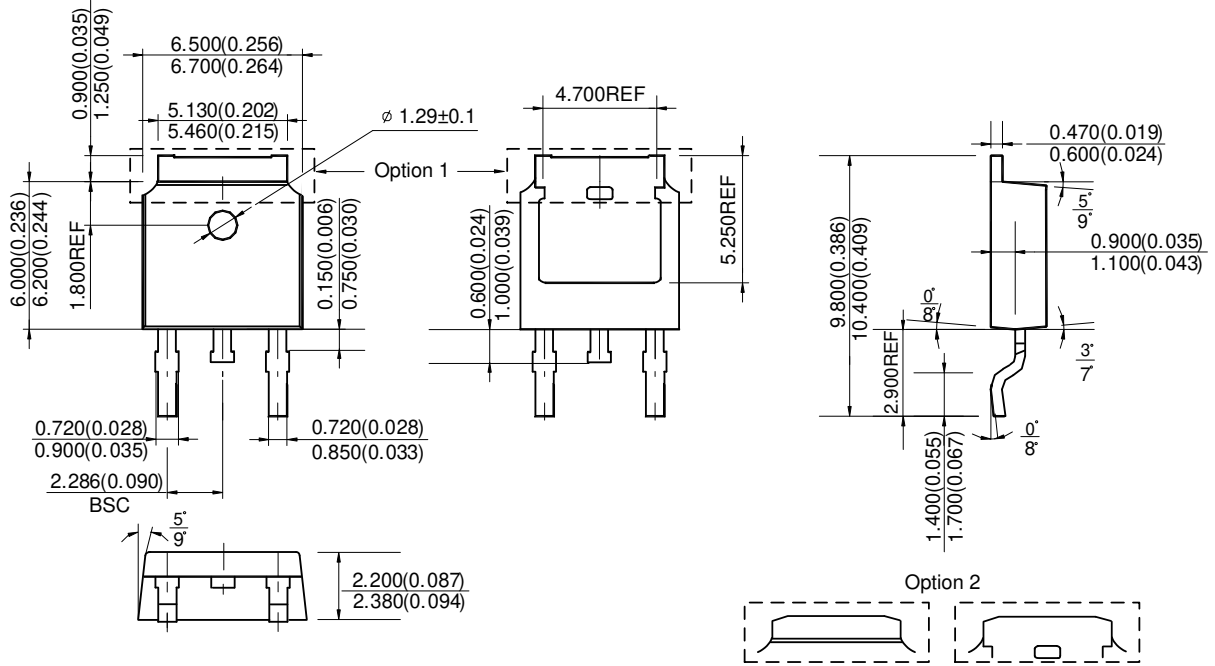

**Package Outline Dimensions** (Cont. All dimensions in mm(inch).)

(4) Package Type: TO252-2 (4)

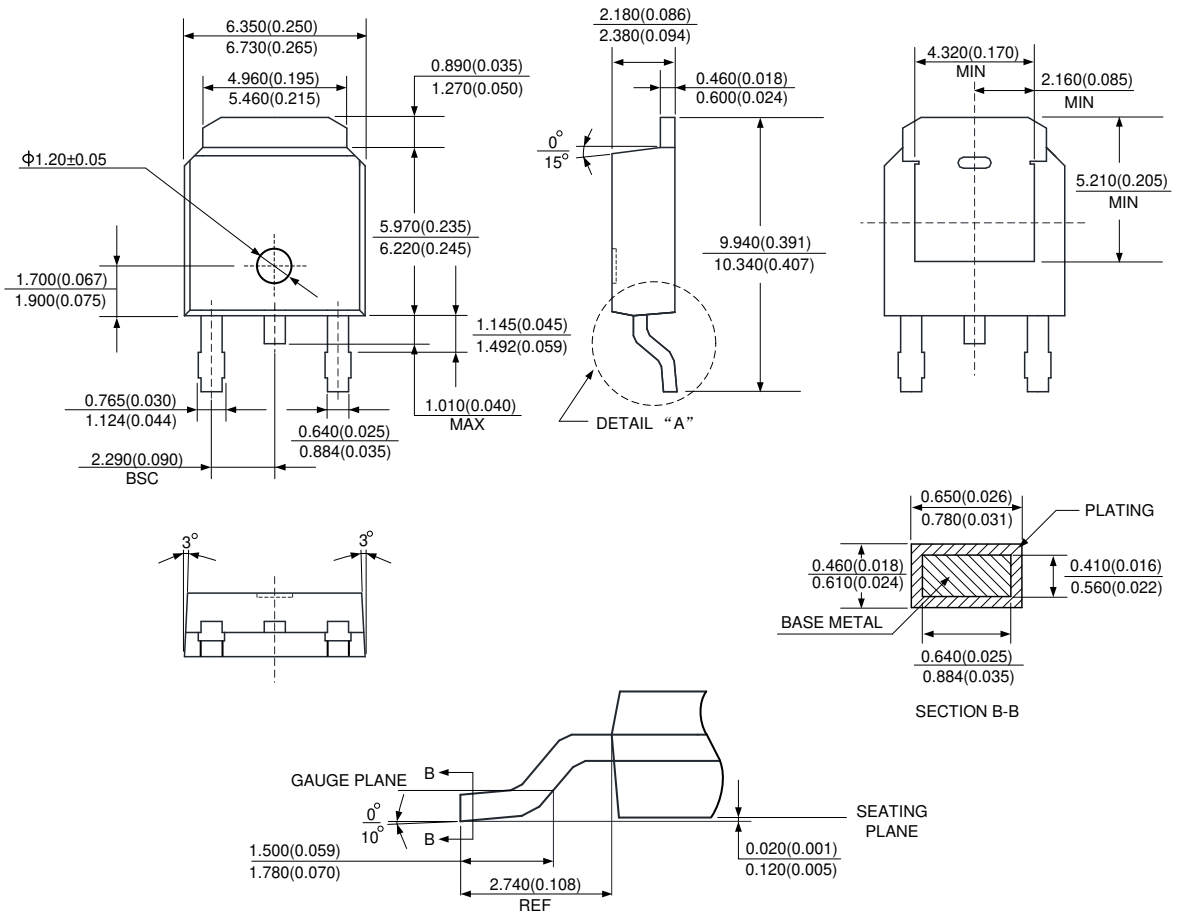

**Package Outline Dimensions** (Cont. All dimensions in mm(inch).)

(5) Package Type: TO252-2 (5)

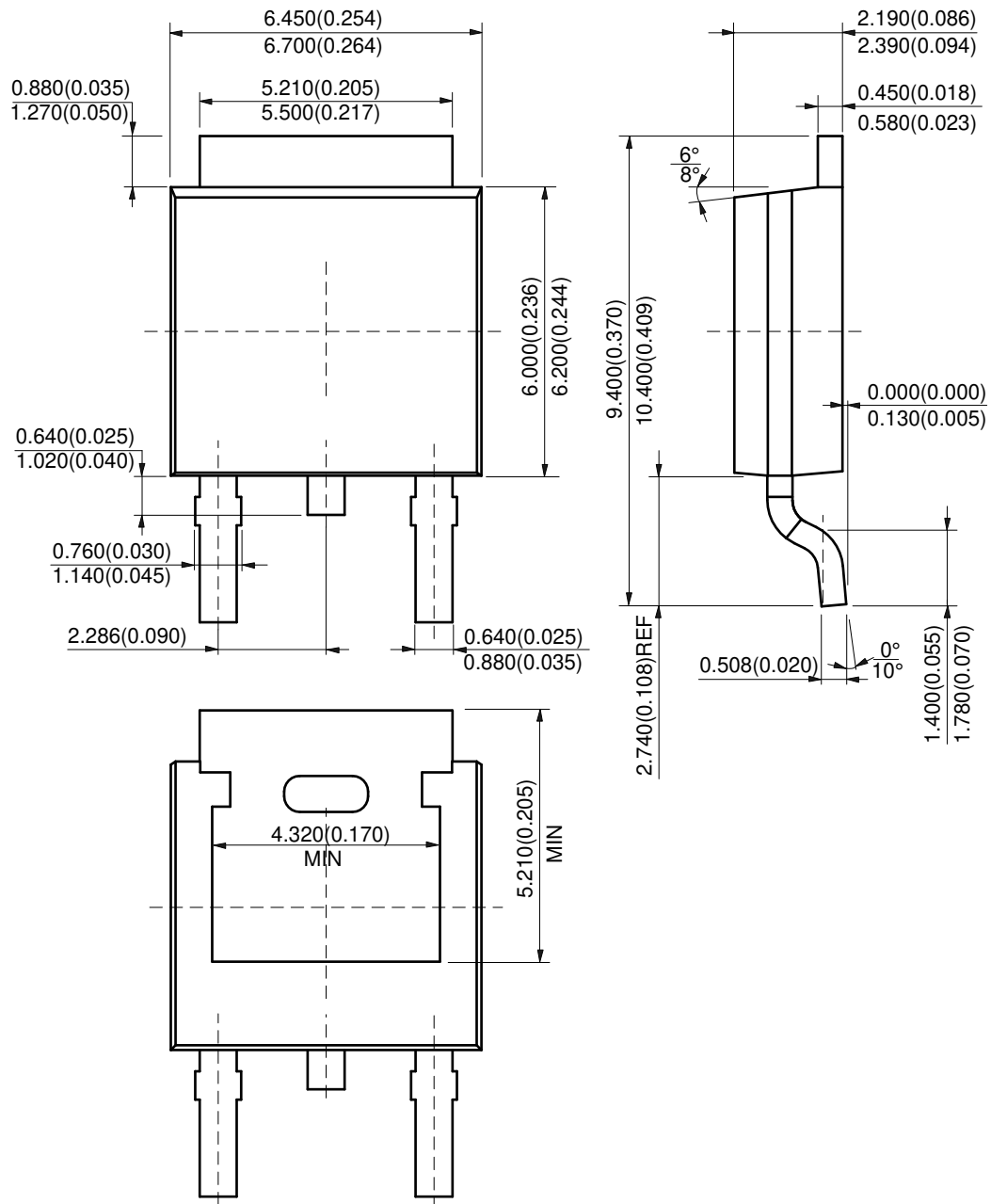



**Package Outline Dimensions** (Cont. All dimensions in mm(inch).)

(6) Package Type: TO220-3

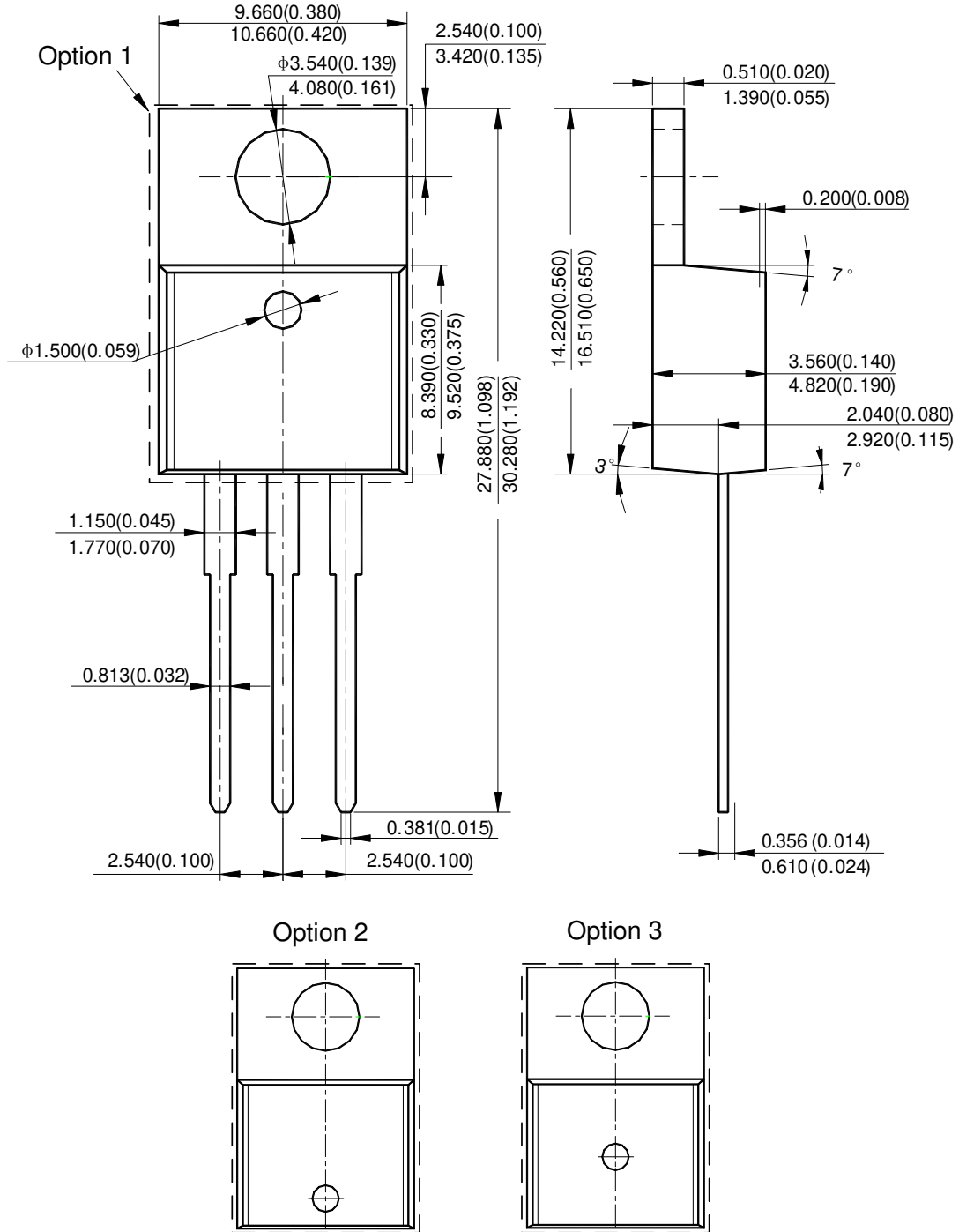

**Package Outline Dimensions** (Cont. All dimensions in mm(inch).)

(7) Package Type: TO263

